



- 2300 Sniper EFI (550-849 Shiny, 550-850 Black, & 550-851 Gold)

Holley Sniper EFI FUEL INJECTION INSTALLATION MANUAL

Read this manual before using this product.

WARNING!

This instruction manual must be read and fully understood before beginning installation. If the instructions are not fully understood, installation should not be attempted. Failure to follow the instructions may result in subsequent system failure and could result in serious personal injury and/or property damage. Keep this manual.

For the safety and protection of you and others as well as your vehicle, only a trained mechanic having adequate fuel system experience should perform the installation, adjustment, and repair.

While undertaking any work involving the fuel system, it is particularly important to remember one of the very basic principles of safety: fuel vapors are heavier than air and tend to collect in low places where an explosive fuel/air mixture may be ignited by any spark or flame resulting in property damage, personal injury, and/or death. Extreme caution must be exercised to prevent spillage and thus eliminate the formation of such fuel vapors. All work involving this product and the fuel system generally **MUST** be performed in a well-ventilated area. Do **NOT** smoke or have an open flame present near gasoline vapors or an explosion may result.

Any components damaged due to failure to follow these instructions will not be covered by the warranty. Failure of any one component does not constitute, nor does it justify, warranty of the complete system. Individual service items are available for replacement of components. If assistance is required or if you need further warranty clarification, please call Holley Technical Service at 1 (270) 781-9741.

TABLE OF CONTENTS

INTRODUCTION & SYSTEM REQUIREMENTS	5
Engine Requirements	5
Fuel System Requirements	5
TOOLS REQUIRED FOR INSTALLATION	5
PARTS IDENTIFICATION	6
THROTTLE BODY INSTALLATION	7
OXYGEN SENSOR INSTALLATION	9
COOLANT TEMPATURE SENSOR INSTALLATION	11
FUEL SYSTEM CONNECTIONS	11
SNIPER EFI MASTER FUEL SYSTEM INSTALL	12
Fuel Pump and Filter Installation	13
Return Line Bulkhead Fitting Installation	13
Fuel Line Installation	15
Hose Assembly	15
ECU WIRING OVERVIEW	17
BASIC WIRING INSTALLATION	18
GENERAL WIRING REFERENCE	19
Throttle Body Connections	19
Pigtail & Loose Wire Connections	19
Connecting Sniper EFI Touchscreen LCD to Sniper EFI	20
NON TIMING CONTROLLED IGNITION SYSTEM WIRING	23
Coil (-) [No Timing Control]	23
Ignition Box Tach Output [No Timing Control]	24
TIMING CONTROLLED IGNITION SYSTEM WIRING	26
Timing Control Preface:	26
MSD (Magnetic) Distributor [Timing Control]	26
Holley Dual Sync Distributor [Timing Control]	31
HANDHELD NAVIGATION	37
Possible Screens	37
INITIAL EFI SETUP	39
Calibration Wizards	39
Sensor Verification	42
Prestart Checklist	43
First Startup	43
After Startup	43
Ignition Timing Check [Without Timing Control]	44
Ignition Timing Check [ECU Controlling Timing]	44
THROTTLE BLADE ADJUSTMENT	45
SYSTEM SETUP	46
Ignition System Setup	46

BASIC TUNING.....	47
Basic Fuel.....	47
Target AFR.....	48
Acceleration Enrichment.....	48
Fuel Prime.....	49
Closed Loop Enable/Disable.....	49
Learn Enable/Disable.....	50
Basic Idle.....	50
Spark.....	51
SYSTEM TUNING.....	51
Outputs.....	51
Engine Setup.....	53
Sniper Setup.....	53
Ignition Setup.....	54
Static Timing.....	54
ADVANCED TUNING.....	55
IAC Rampdown.....	57
Idle Spark.....	58
Idle Speed.....	59
SNIPER EFI MONITOR.....	60
Monitors.....	60
Multi-Gauge.....	60
Changing Monitor Channel Scaling.....	61
Custom Configuring Dash 1 Dash 2 or Dash 3.....	61
NITROUS TUNING ON HANDHELD.....	62
BOOST CONTROL ON HANDHELD.....	62
ADVANCED TABLES ON HANDHELD.....	62
TUNING DEFINITIONS.....	63
DATALOGGING & FILE TRANSFERS.....	72
Taking a Datalog with the 3.5" TSCLCD.....	72
Downloading Global Configuration from Sniper EFI Throttle Body to SD card:.....	73
Loading Calibration into Sniper EFI ECU.....	73
LAPTOP SUPPORT.....	74
Viewing Global Configuration with Sniper EFI Software without USB Cable:.....	74
Viewing Datalog with Sniper EFI Software:.....	75
TROUBLESHOOTING.....	76
Troubleshooting Guide.....	76
Sensor Verification.....	76
Sensor Diagnostics and Statuses.....	76

INTRODUCTION & SYSTEM REQUIREMENTS

Holley Performance Products has written this manual for the installation of the **Sniper EFI** TBI fuel injection system. This basic manual contains the information necessary for the installation of the throttle body, wiring, and sensors. Please read all the **WARNINGS** and **NOTES**, as they contain valuable information that can save you time and money. It is our intent to provide the best possible products for our customer; products that perform properly and satisfy your expectations.

Engine Requirements

Before moving forward with the installation, please verify your vehicle meets the engine and fuel system requirements below:

- Engine is in sound mechanical condition
- Engine is a naturally aspirated (no supercharger, turbocharger, etc.) 4, 6 or 8 cylinder
- Engine has a 2 barrel, 2300 style flange intake manifold*
- Unleaded fuel only
- Any RTV silicone sealants used on the engine are sensor safe

* Any 2300 flange intake manifold will work. Make sure to use proper gaskets to seal the throttle body to the intake manifold and ensure that there are no vacuum leaks.

Fuel System Requirements

The Sniper EFI system requires a high pressure fuel pump capable of operating at 60 psi with at least 50 gallon per hour of fuel flow (more fuel flow may be needed for higher horsepower engines). When selecting a pump, and lines, be sure each component is designed to perform at high pressure. Holley offers a variety of fuel pumps, hoses and accessories to complete your installation. For best results, Holley strongly recommends an in-tank pump. Installing the fuel pump in the tank results in quieter operation, less chance of cavitation and a reduction in pump temperature. If mounting the pump in the tank is not an option, install the pump as close as possible to the tank. Within 2-feet of sending unit is recommended. Once the fuel system is installed checking the fuel pressure on the inlet side of the Sniper EFI is recommended, fuel pressure needs to be between 55-65 PSI.

The **550-849K**, **550-850K**, and **550-851K** fuel injection systems include the complete fuel system.









TOOLS REQUIRED FOR INSTALLATION



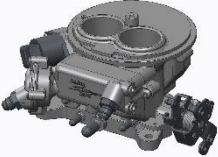





- | | | |
|---|---|---------------------|
| • Standard Wrench Set | • Small Blade Screwdriver | • Allen Wrench Set |
| • Medium Blade Screwdriver | • #2 Phillips Screwdriver | • Digital Voltmeter |
| • Drill and Assorted Bit Sizes | • Terminal Crimping Tool | |
| • Factory Service Manual for your vehicle | • 7/8" Drill Bit (step-bit recommended) | |

An assistant is necessary for some installation and adjustment procedures and should be present for safety reasons.

WARNING! Before disconnecting the battery, we recommend locating a Clean Switched 12 volt ignition source. This source needs to have 12 volts while cranking and with the key in the run position. Disconnect battery before proceeding with any work to the vehicle.

PARTS IDENTIFICATION

ITEM #	IMAGE	DESCRIPTION	QTY	SERVICE P/N	NOTES
1		Bosch Wide Band Oxygen Sensor	1	554-155	<ul style="list-style-type: none"> Use of leaded fuel will degrade sensor. Prolonged use will require periodic replacement. Mounting procedure below is critical for system performance
2		Clamp-on Oxygen Sensor Bung	1	534-58	<ul style="list-style-type: none"> Requires 3/4" hole to be drilled Mounting procedure below is critical for system performance In order to help prevent condensation in the exhaust from damaging the sensor, ensure that the sensor is installed with at least 10 degrees of vertical angle.
3		Coolant Temperature Sensor	1	543-120	<ul style="list-style-type: none"> 3/8" NPT Threads – Adapters to 1/2" NPT are available Must be installed in a coolant passage in either the intake manifold or cylinder head. Do not install in thermostat housing.
4		Sniper EFI Throttle Body Assembly	1	N/A	<ul style="list-style-type: none"> 2300 Flange Sniper EFI Throttle Body Includes ECU, fuel injectors, Manifold Air Pressure (MAP) sensor, Throttle Position Sensor (TPS), Manifold Air Temp Sensor (MAT), and an Idle Air Control Valve (IAC)
5		Air Cleaner Gasket	1		<ul style="list-style-type: none"> Hardware and gaskets for mounting throttle body to intake manifold Should be tightened down progressively in a criss-cross pattern to 5-7ft./lbs. Overtightening will damage throttle body!
6		5/16-24 Nuts	4	N/A	
7		Flange Gasket	1		
8		Manifold Flange Studs	4	N/A	
9		3.5" Touch Screen Controller	1	553-115	<ul style="list-style-type: none"> Includes harness to connect directly to CAN connector
10		Output Harness	1	558-491	<ul style="list-style-type: none"> Mates to Input/Output connector on Main Wiring Harness and can be used for A/C Shutdown, Electric Fan #1 Output, and/or Electric Fan #2 Output.
11		Main Harness and Ignition Adapter	1	558-490	

12		Throttle Bracket, Throttle and Transmission	1	1953	<ul style="list-style-type: none"> Used for throttle cable and transmission kickdown
13		Throttle Bracket, Throttle Only	1	1953	<ul style="list-style-type: none"> Used on applications with no transmission kickdown
14		1/4-20 x 5/8 Socket Head Cap Screw	1	N/A	<ul style="list-style-type: none"> Used to secure throttle cable bracket to throttle body with a lock washer
15		Throttle and Cruise Control Stud	1	20-36	<ul style="list-style-type: none"> Used for various throttle and/or transmission combinations
16		Throttle Lever Ball	1	20-2	<ul style="list-style-type: none"> Used to secure throttle cable bracket to throttle body with a lock washer
17		Throttle Lever Stud	1	20-37	<ul style="list-style-type: none"> Used for various throttle and/or transmission combinations
18		Transmission Kickdown Stud	1	20-40	
19		Lock Washers	3	N/A	
20		1/4-28 Nuts	2	N/A	

THROTTLE BODY INSTALLATION

1. Start by labeling all vacuum lines for easy identification, i.e. brake booster & vacuum advance for distributor. If any lines appear damaged, now is the time to replace them. Next, remove the carburetor, clean the gasket mating surface, and install the provided intake flange gasket on the intake manifold.
2. Place the Sniper EFI throttle body on top of the new flange gasket on the manifold. Install the hold down nuts and snug down progressively in a "criss-cross" pattern (60-80 in./lbs.). Depending on your application, this is also the time to install your throttle bracket and transmission kickdown brackets provided with your Sniper EFI Kit. You may be able to re-use the stock style throttle stud or transmission studs from your carburetor. If not, we have provided several universal throttle ball/stud options.

Throttle Linkage/Bracket Side View

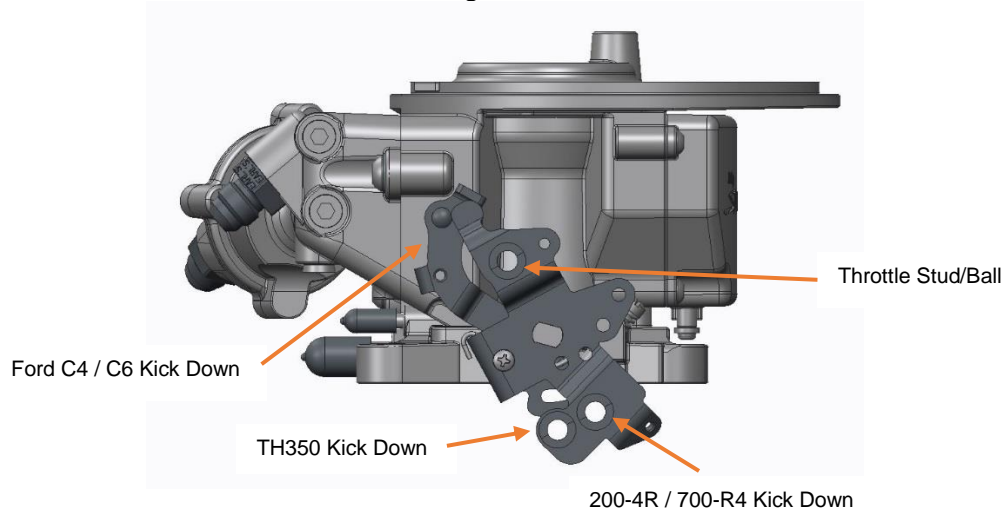

3. Reconnect the throttle and if applicable transmission kick-down linkage. Be sure to check for any binding conditions and correct before proceeding. Poorly routed throttle cables & linkages can cause throttle pedal issues.
4. Reconnect the appropriate vacuum hoses to the Sniper EFI throttle body. **Be sure to plug any vacuum sources not used on both the Sniper EFI Throttle Body and on the Engine.**

Vacuum Port Side View

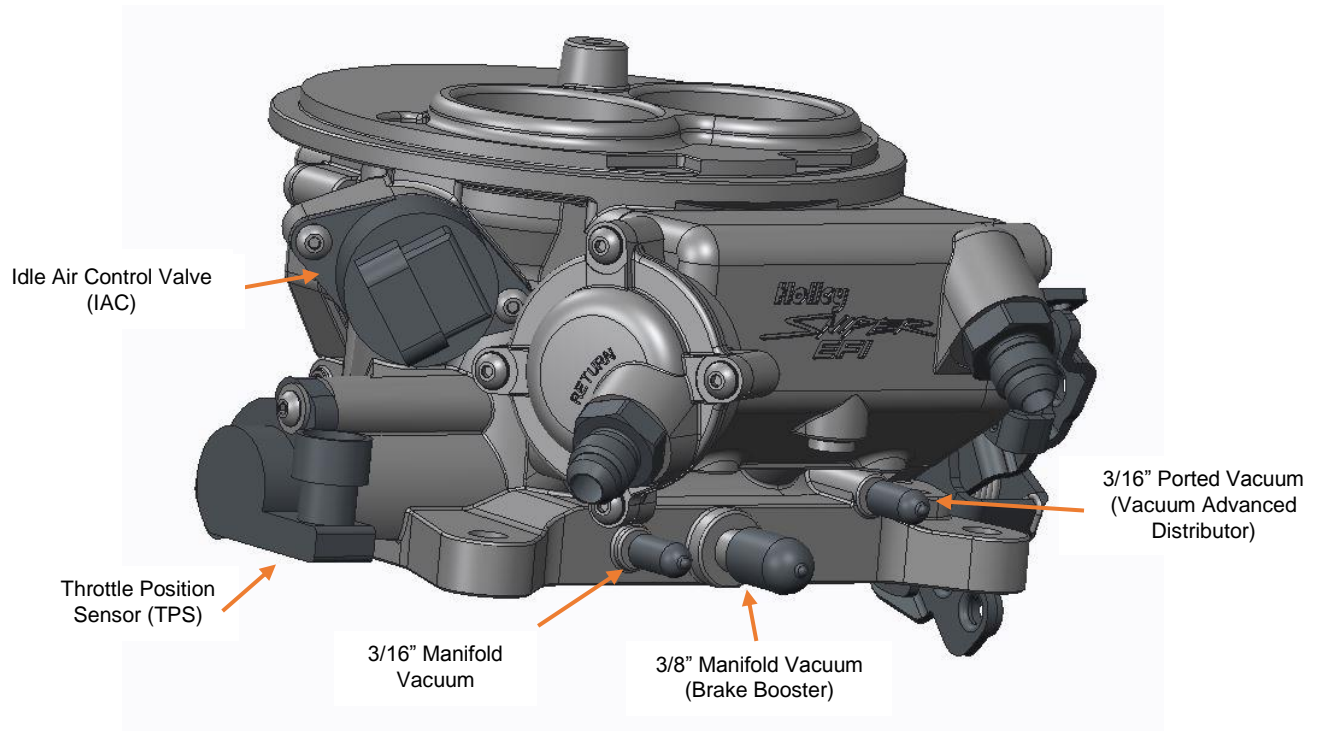

OXYGEN SENSOR INSTALLATION

WARNING!

Failure to disconnect the AIR pump or locating the oxygen sensor downstream from AIR injection will result in an extremely rich mixture, which could cause drivability problems and severe engine damage. If disconnecting AIR pump, check with local ordinances for the legality of this procedure in your area.

Your vehicle may already have an O2 sensor bung welded into the exhaust. This bung location needs to be verified before using it with the Oxygen sensor included in the Sniper EFI system. Ideally the bung will be 6-10 inches after the collector for a true reading of all cylinders and have a minimum of 18" length past the sensor location. If the vehicle is equipped with a catalytic converter, the bung must be between the engine and the catalytic converter. The bung also must be on the top side of the tube so moisture cannot collect on the oxygen sensor. If there is an acceptable bung already present, go ahead and tighten the oxygen sensor supplied with your Sniper EFI in the bung. If there is not an acceptable bung already in the exhaust, please plug all poorly placed bungs and follow the following instructions for the included Clamp-On O2 bung.

If needed, Hooker Blackheart offers different diameter Clamp-On O2 Bung kits:

2.25" Diameter: [71014303-RHKR](#)

2.5" Diameter: [71014302-RHKR](#)

3.0" Diameter: [71014301-RHKR](#)

1. Locate a position for the oxygen sensor as close to the engine as possible. The oxygen sensor should be mounted at a point where it can read a good average of all the cylinders on one bank. This would be slightly after all the cylinders merge. If you have long tube headers, mount the sensor approximately 6-10" after the collector. You must have at least 18" of exhaust pipe after the sensor.
2. If your vehicle has catalytic converters, the oxygen sensor **MUST** be located between the engine and the catalytic converters. It is also **CRITICAL** that the oxygen sensor is NOT installed in the bottom of the exhaust tube. This will help prevent condensation in the exhaust tubing from entering the sensor. The clamp-on kit installation requires a 3/4" hole to be drilled in the exhaust system. Refer to main installation manual for more details.

Note: Verify that the O2 cable is supported correctly and away from heat sources such as the exhaust. If the O2 cable has melted it is not something fixed under warranty and will require the unit to be sent back to Holley to be repaired at customer cost.

3. Ensure the location for the sensor is at the angle in **Figure 1**. This will help prevent condensation in the exhaust tubing from entering the sensor. The sensor can be mounted on either side of the tubing.

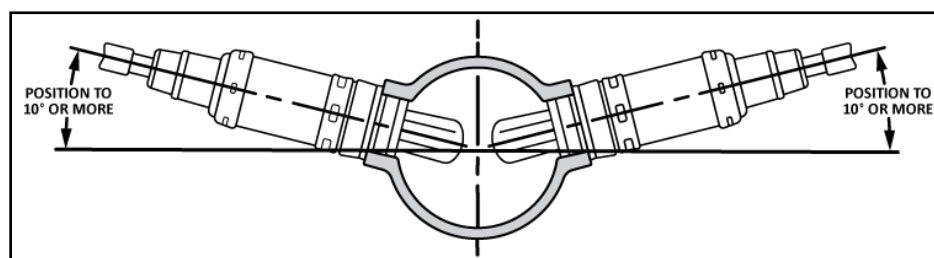

Figure 1

4. Mark the center of the casting on the exhaust tube and drill a 3/4" hole. Deburr the hole after drilling (Figure 2).

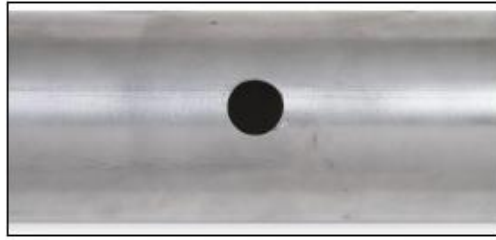

Figure 2

5. Place the gasket on the tube (Figure 3), then the casting on the tube (Figure 4). Slip a clamp on one side and lightly tighten. Slip the second clamp on and lightly tighten (Figure 5). It is necessary to use a small amount of anti-seize on the threads of the T bolt clamps to prevent thread damage.



Figure 3



Figure 4



Figure 5

NOTE: Never run the engine with the oxygen sensor installed if it is not plugged in and powered by the ECU, or it will be damaged. If you need to plug the hole temporarily, use an O2 sensor plug or a spark plug with an 18mm thread.



COOLANT TEMPERATURE SENSOR INSTALLATION

Install the Coolant Temperature Sensor into a 3/8" NPT coolant passage in either the intake manifold or cylinder head. Do not overtighten or damage to the cylinder head or intake may occur. It is best to drain the some of the coolant before the sensor is installed. Use thread sealer or a small amount of thread tape. Do not install the sensor in the thermostat housing, or in an area that will not see a constant flow of coolant.

FUEL SYSTEM CONNECTIONS

Connect fuel feed and return hose. It is mandatory that the fuel outlet/return comes from the fuel pressure regulator and the fuel inlet must go to the inlet fitting on the 2300 Sniper EFI. The inlet and outlet are indicated in **Fuel Fitting Overview** below. The Sniper EFI System comes with a built in fuel pressure regulator, factory set at 58.5psi. We recommend at least a 3/8" feed line and 3/8" return line.

Note: Fuel pressure should be checked on the inlet fuel line before initial start up during the fuel pump prime. We recommend Earl's Part number 100187ERL (0-100 psi Liquid filled gauge) & AT100199ERL (-6AN Gauge Adapter) to check fuel pressure.

Fuel Fitting Overview

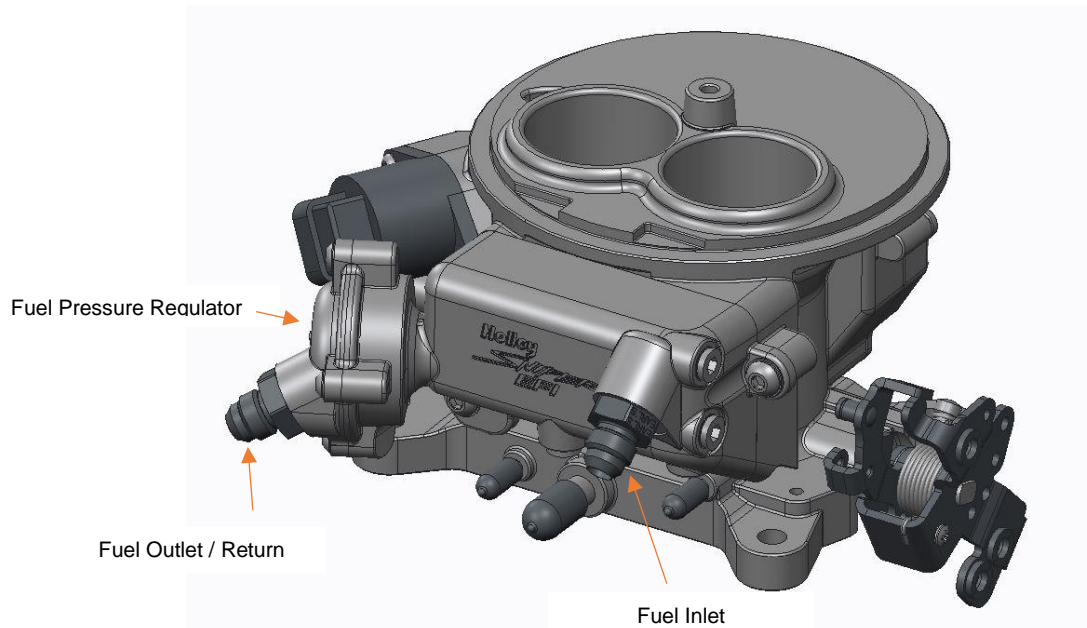

DANGER! Take precautions to ensure that all fuel components are away from heat sources, such as the engine or exhaust pipes. A fire or explosion hazard could cause serious injury or death!

DANGER! Before disconnecting or removing fuel lines, ensure the engine is cold. Do not smoke. Extinguish all open flames. An open flame, spark, or extreme heat near gasoline can result in a fire or explosion causing property damage, serious injury, and/or death.

DANGER! Never get under a vehicle supported only by a jack. Serious injury or death can result from vehicles falling off of jacks. Before working underneath a vehicle, support it solidly with jack stands.

SNIPER EFI MASTER FUEL SYSTEM INSTALL

If you did not purchase a master fuel system Sniper EFI Kit, please make sure your fuel system is plumbed properly. Can use the guidelines below to verify it is correct. If you would like to purchase the fuel system components that come in the master fuel system Sniper EFI kits, part number 526-5 and 526-7 are available for purchase.

ITEM	DESCRIPTION	QTY	SERVICE PART
1	Universal Electric Fuel Pump	1	12-920
2	20ft of 3/8" Vapor Guard Fuel Hose	1	760066ERL
3	3/8" Vapor Guard Hose Clamps	11	750006ERL
4	Post Fuel Filter 10 micron	1	Holley P/N 562-1 or NAPA P/N 3482
5	Pre Fuel Filter	1	NAPA P/N 3033
6	Mechanical Fuel Pump Block-off Plate & Gasket	1	N/A
7	-6AN to 3/8" Vapor Guard Hose End	4	750166ERL
8	Fuel Cuff (240MM long)	1	12-719
9	9/16" Stat-O-Seal	2	178009ERL
10	-6AN Bulkhead Nut	2	24506063
11	-6AN Bulkhead Fitting	1	23506063

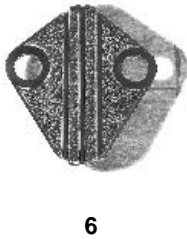

Fuel Pump and Filter Installation

The following section covers the installation of the in-line pump as well as the pre and post filters. **The fuel pump MUST be mounted lower than the lowest part of the fuel tank, and as close to the tank as possible. The fuel tank must also be properly vented.**

1. Use below as a reference for the orientation and location of the fuel system components:

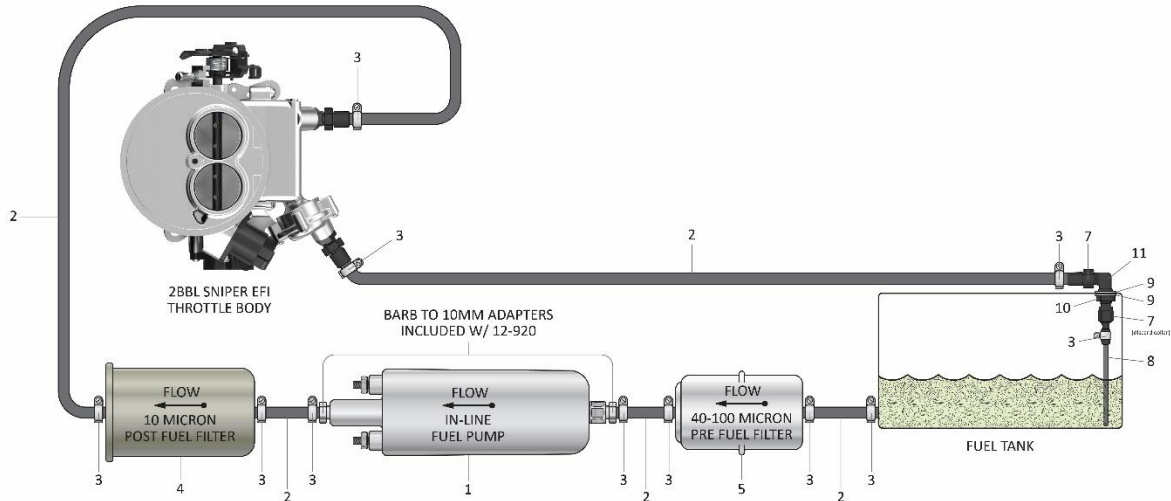

2. Mount the electric fuel pump as close to the fuel tank outlet as possible with the bracket provided. Mounting the fuel pump in this manner will insure that the pump will prime easily to ensure faster starts.
3. There are two filters included with this kit. The pre-filter (**Item 5**) **MUST** be installed between the fuel tank and the fuel pump inlet (unless an in-tank pump is used in place of the pump in this kit). The purpose of this filter is to protect the fuel pump from particles of dirt or other foreign material. The filter should be installed with the arrow on the filter pointing in the direction of the fuel flow.
4. The post-fuel filter (**Item 4**) should be installed between the electric pump outlet and TBI unit. This is a 10 micron EFI filter. Position the filter, so the fuel hoses can be routed without kinks or sharp bends. The filter should be installed with the arrow on the filter pointing in the direction of the fuel flow.



WARNING! Ensure both filters are installed in the proper direction. A flow direction arrow is printed on the side of the filter to indicate the direction of fuel flow. Failure to do so will result in a system malfunction.

Return Line Bulkhead Fitting Installation

The Sniper EFI system requires a return fuel line to the fuel tank. This kit includes the hose and fittings necessary for a return line installation on most vehicles. Some late model vehicles that were originally equipped with a throttle body injection system may already have a return line to the fuel tank that can be utilized. The return line must not present a pressure restriction to the return fuel flow. There should never be more than approximately 3 PSI of pressure in the return line. A line that is too small, or has restrictions will cause tuning problems with the system.

DANGER! Do not use the vapor canister lines as a fuel return line. Possible fuel leaks may create a fire or explosion hazard, causing serious injury or death.

DANGER! Proper installation of the fuel return line will necessitate complete removal of the fuel tank. This work should be done by a fuel tank specialist, who regularly does this work and is familiar with safety regulations and precautions necessary to do this work. If a person attempts this work, who is not familiar with the safety regulations and precautions, an explosion hazard may result causing serious injury or death.

Choose an ideal location for the bulkhead fitting to be installed. The fitting must be installed through a flat surface where the nut can be tightened from the bottom. It must also be installed in a location where the fuel cuff will not interfere with the sending unit float. If possible, we strongly recommend removing, cleaning, and drilling into the sending unit. The fitting must be oriented as shown below in **Figure 44**. The item numbers from section 27.1 are referenced.

DANGER! IF DRILLING INTO TANK (RATHER THAN SENDING UNIT), HOLLEY RECOMMENDS HAVING YOUR TANK PROFESSIONALLY CLEANED BEFORE DRILLING. IF YOU CHOOSE NOT TO HAVE THE TANK PROFESSIONALLY CLEANED, DRAIN THE TANK COMPLETELY, LET DRY, AND FILL WITH WATER.

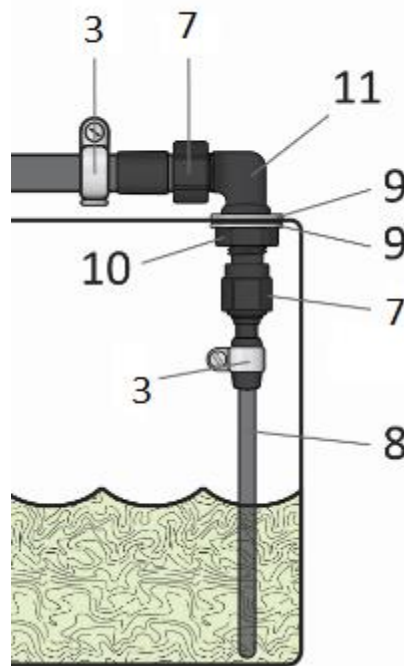

1. Drill a 9/16" hole and debur. Remove all metal shavings and particles from tank.
2. Install bulkhead fitting with one Stat-O-Seal above the surface, and one below.
3. Screw the bulkhead nut onto fitting from the bottom, inside of the tank. Snug with a wrench. A spare bulkhead nut has been provided and will not be used in this installation.
4. Insert the barbed end of a straight Vapor Guard hose end (**Item 7**) into an end of the fuel cuff (**Item 8**) and ensure the cuff covers both barbs.
5. Slide hose clamp (**Item 3**) over fuel cuff and fitting and tighten to secure.
6. Screw fuel cuff assembly to bottom of bulkhead nut and snug with a wrench. Ensure bottom of cuff will be submerged in fuel as shown in. Cuff can be trimmed if necessary.

Fuel Line Installation

With the fuel pump, filters, and bulkhead fitting all in place. You are now ready to install the fuel lines. Some connections will use hose clamps (**Item 3**), while others will use AN hose ends (**Items 7**) These connections are noted in. Be sure to read and thoroughly understand all steps, notes, and hose assembly instructions below before proceeding with the fuel line installation.

DANGER! Failure to use a fuel hose that meets SAE J30 standards could result in fuel leaks. A fuel leak may result in a fire or explosion hazard, which could cause serious injury or death.

DANGER! Failure to use a steel fuel line that meets SAE J526 standards could result in fuel leaks. A fuel leak may result in a fire or explosion hazard, which could cause serious injury or death.

DANGER! Rigid fuel line tubing should be used for under vehicle runs, such as along vehicle frame rails or under floor pans. Failure to do so is a potential fire or explosion hazard, which could cause serious injury or death

1. If using steel line, the hose (**Item 2**) can be used to connect the steel line to the pump and filters. You should not connect a rubber hose directly to a steel line unless the end of the line has a “bead/nipple” or barb that retains the hose. If the steel line is just cut off, purchase a compression fitting that a barbed hose end can be installed on, or use a tool to roll a bead/nipple on the end of the steel line.
2. If you plan to install a fuel pressure gauge, do so at this time. The Sniper EFI systems are designed for an operating pressure of 58.5 PSI. Although this is factory pre-set, it is ideal that it be checked.
3. If using the existing fuel lines, inspect and replace any hose, clamps, or fuel line showing **ANY** sign of aging.
4. Anchor all fuel lines securely to solid chassis members at 1 ½ foot intervals using rubber coated steel clamps (not supplied). Use of only approved steel fuel line tubing will afford maximum fuel line protection against road hazards and premature wearing due to flexing, temperature extremes, road salt, weather, etc.

Hose Assembly

1. Cut the hose square with a sharp knife or Earls Hand-Held Hose Cutter (D022ERL).



2. Install the fitting, by sliding the fitting into the hose. Make sure the hose seats flush with the fitting. (Figure 45-2)



3. Secure the hose clamp.

1. Provide for length change.

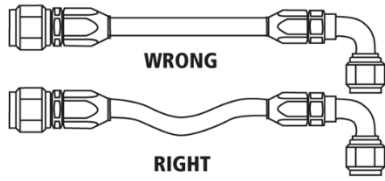

In straight hose installations, allow enough slack in the hose line to provide for changes in length that will occur when pressure is applied. This change in length can be from +2% to -4%.

2. Avoid twisting and orient properly.

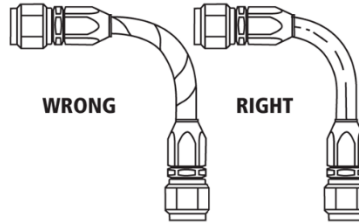

Do not twist during installation. This can be determined by the printed layline on the hose. Pressure applied to a twisted hose can cause hose failure or loosening of connections.

3. Protect from hazardous environment.

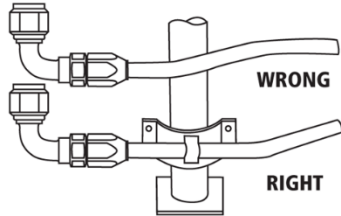

Keep hose away from hot parts. High ambient temperature will shorten hose life. If you can not route it away from heat source, insulate it.

4. Avoid mechanical strain.

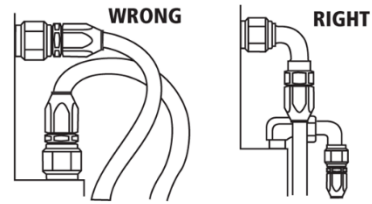

Use elbows and adapters in the installation to relieve strain on the assembly and to provide easier and neater installation that are accessible for inspection and maintenance.

5. Use proper bend radius.

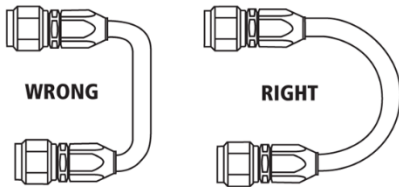

Keep the bend radius of the hose as large as possible to avoid collapsing of the hose and restriction of flow. Follow catalog specs on minimum bend radii.

6. Use proper bend radius (cont'd).

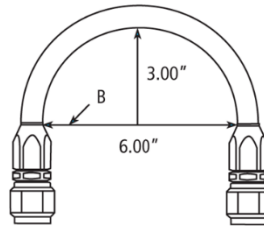

Minimum bend radius is measured on the inside bend of the hose. To determine minimum bend, divide the total distance between ends (B length) by 2. For example, B=6, minimum bend radius=3.

7. Secure for protection.

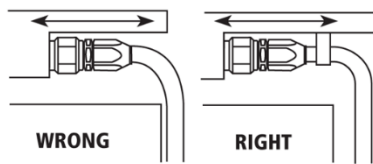

Install hose runs to avoid rubbing or abrasion. Use Earl's Hose Clamps to support long runs of hose or to keep away from moving parts. It is important that the clamps not allow the hose to move. This movement will cause abrasion and temperature hose failure.

8. Avoid improper hose movement.

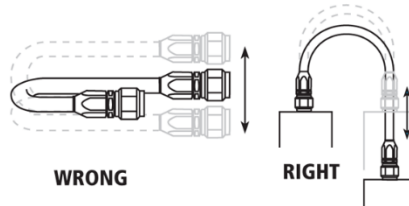

Make sure relative motion of the machine components produces bending rather than twisting of the hose. Hose should be routed so that the flex is in the same plane as the equipment movement.

ECU WIRING OVERVIEW

The Sniper EFI throttle body comes with sensors pre-wired for easy installation. The illustrated diagram below is intended as an overview of how the system should be wired. Remember, the main ECU power and ground must be connected directly to the battery AFTER all other wiring installation has been performed. The 8 pin connector applies to part numbers 550-852, 550-853 & 550-854.

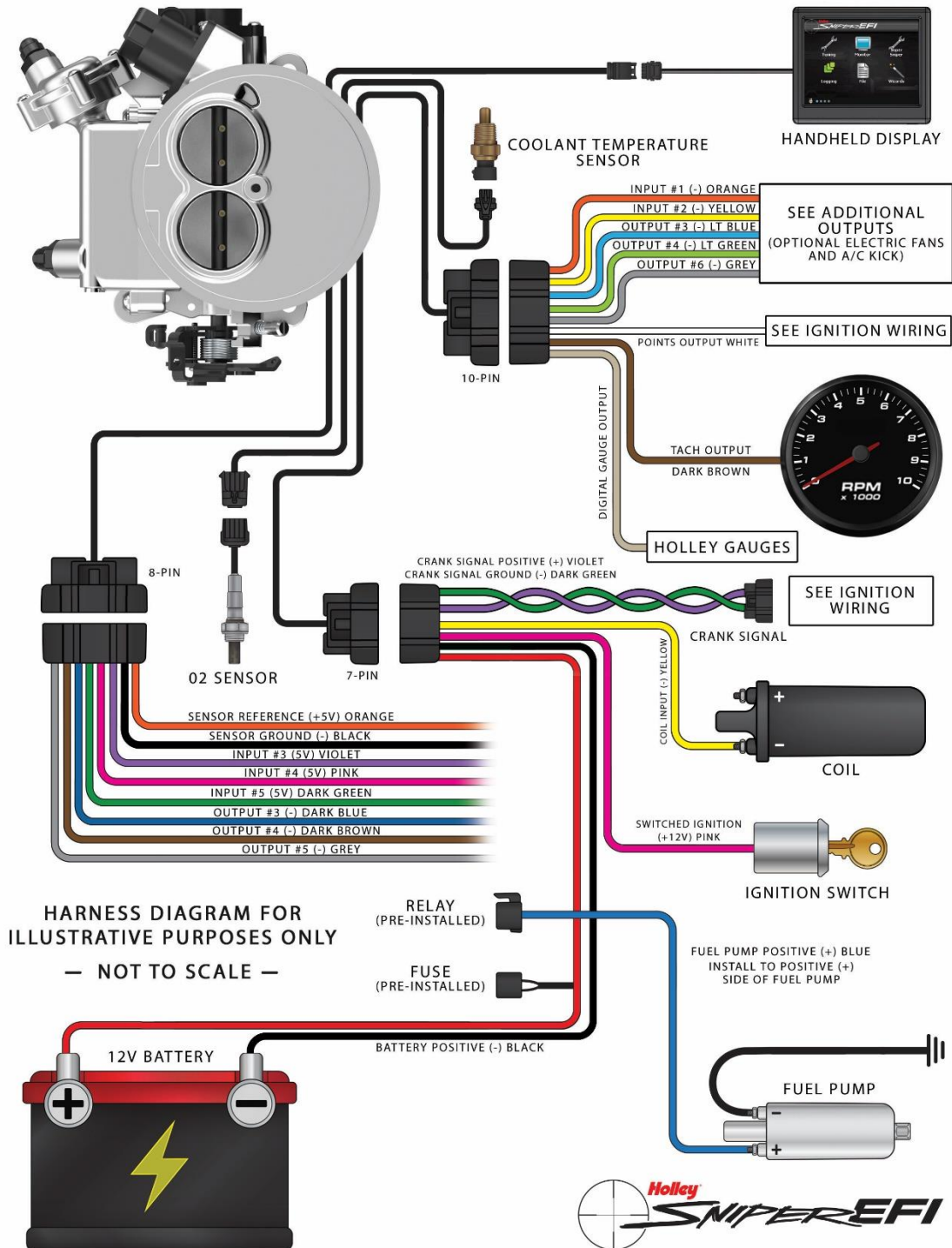

BASIC WIRING INSTALLATION

The Sniper EFI throttle body has the following connectors and connections. Wires are labeled as well for identification. **Not all of these wires will always be used.** The following is a main overview, with more detailed installation information following.

7 Pin Connector – Main Sniper Wiring Harness: Mating Harness PN 558-490

Pin	Color	Labeled Name	Function
E	Red	Battery Positive (+)	Connects directly to battery positive terminal
G	Black	Battery Negative (-)	Connects directly to battery negative terminal
C	Blue	Fuel Pump Output (+)	+12v Fuel Pump Supply from Relay
A	Violet	Crank Signal Positive (+)	Engine Speed Signal Input (see Ignition Wiring Section)
B	Dark Green	Crank Signal Negative (-)	Engine Speed Signal Ground (see Ignition Wiring section)
D	Yellow	Coil (-) Input	Engine Speed Input (see Ignition Wiring section)
F	Pink	Switched Ignition (+12v)	NOTE: must remain powered during cranking

10 Pin Connector – Mating Harness PN 558-491 8 wires are populated. This connector contains:

Pin	Color	Labeled Name	Function
A	Orange	Input #1 (-)	Optional - Connect to a ground triggered A/C relay
B	Yellow	Input #2 (-)	Optional - Connect to a programmable ground input
C	Light Blue	Output #1 (-)	Optional – Connect to Fan #1 relay ground trigger
D	Light Green	Output #2 (-)	Optional – Connect to Fan #2 relay ground trigger
E	Grey	Output #6 (-)	Optional – Connect to ground side trigger of A/C shutdown relay
F	White	Points Output	Used to trigger a CD ignition box or the included Coil Driver Module
G	Dark Brown	Tach Output	Used to drive an aftermarket tachometer
H	Tan	Digital Gauge Output	Used to drive Holley EFI analog gauges via 554-130 Gauge Module

8 Pin Connector (Applies to PNs 550-852, 550-853 & 550-854) – Mating Harness PN 558-492 8 wires are populated.

Pin	Color	Labeled Name	Function
A	Orange	Sensor Reference (+5V)	Optional - +5V Supply for 0-5V Sensor
B	Black	Sensor Ground (-)	Optional - Ground for 0-5V Sensor
C	Violet	Input #3 (5V)	Optional - Programmable 0-5V sensor input
D	Pink	Input #4 (5V)	Optional - Programmable 0-5V sensor input
E	Dark Green	Input #5 (5V)	Optional - Programmable 0-5V sensor input
F	Dark Blue	Output #3 (-)	Optional - Programmable ground output
G	Dark Brown	Output #4 (-)	Optional - Programmable ground output
H	Grey	Output #5 (-)	Optional - Programmable ground output

Touch Screen LCD Display – This small 4 pin CAN connector plugs into the Handheld Touch Screen display unit. Replacement 3.5" Touch Screen Handheld part number is 553-115.

Coolant Temperature Connector - Connects to coolant temperature sensor. Replacement Coolant Temperature Sensor part number is 543-120.

Oxygen Sensor Connector - Connects to oxygen sensor. Replacement Oxygen Sensor part number is 554-155.

GENERAL WIRING REFERENCE

An EFI system depends heavily on being supplied a clean and constant voltage source. The grounds of an electrical system are just as important as the power side.

Sniper EFI contains multiple processing devices that require clean power and ground sources. The wiring for them must be installed in such a manner that they are separated from “dirty” power and ground sources.

DO'S

- Install the main power and ground directly to the battery. To the POSTS/TERMINALS, not to any other place.
- Keep sensor and crank signal (distributor) wiring away from high voltage or “noisy/dirty” components and wiring, especially secondary ignition wiring (plug wires), ignition boxes, water pumps, fans and other associated wiring. It is best that the plug wires not physically contact any EFI wires.
- Properly crimp or crimp and solder any wire connections. Apply quality heat shrink over any of these connections.
- It is critical that the engine has a proper ground connection from the battery to the chassis, and the battery to the engine.

DON'TS

- NEVER run high voltage or “noisy/dirty” wires in parallel (bundle/loom together) with any EFI sensor wiring. If wires need to cross, try to do so at an angle.
- Don't use the electric fan outputs to directly power a fan. They must only trigger a relay.
- Don't use improper crimping tools.
- Don't use things like “t-taps”, etc. Use proper crimpers/solder and heat shrink.
- It is never recommended to splice/share signal wires (such as TPS, etc.) between different electronic control units (i.e. “piggyback”).
- Don't connect the red/white switched +12V wire to “dirty” sources, such as the ignition coil, audio systems, or 12V sources connected to HID head lamps.
- NEVER start an engine with a battery charger attached

Throttle Body Connections

1. **7 pin Connector** – Connects to the included 558-490 main harness.
 2. **10 pin Connector (optional)** – Connects to included 558-491 I/O harness.
 3. **8 Pin Connector (optional & applies to 550-852 , 550-853 & 550-854)** - Connects to optional 558-492 Super Sniper I/O harness
 4. **Touch Screen LCD Display** – This small 4 pin CAN connector plugs into the 3.5” Handheld Touch Screen display unit.
 5. **Coolant Temperature Connector** – Connects to coolant temperature sensor.
 6. **Oxygen Sensor Connector** – Connects to oxygen sensor.
- Note: All connections on the Sniper system are unique and cannot be plugged into the wrong component.

Pigtail & Loose Wire Connections

1. **Pink Wire = 12V Switched** - Should be connected to a switched +12 volt power source. Power source should only be active when the ignition is on. Make sure source has power when engine is cranking as well (check with voltmeter). Not all sources apply power when the ignition switch is in “cranking” position. **DO NOT connect to a “DIRTY” source like an ignition coil!**
2. **Red Wire = Battery Positive** – Connect directly to the battery post. This powers the Sniper EFI system.
3. **Black Wire = Battery Negative** – Connects directly to battery negative post.
4. **Blue Wire (Optional) = +12v Fuel Pump Relay Power Output** - Used to directly power a fuel pump (max current 15A). Make sure to terminate blue wire properly if not utilizing blue wire to provide power to the fuel pump.

The Sniper EFI throttle body has the following connectors and connections. Wires are labeled as well for identification. **Not all of these wires will always be used.** The following is a main overview, with more detailed installation information following.

Connecting Sniper EFI Touchscreen LCD to Sniper EFI

Connect the Sniper EFI Handheld to the main harness. This is a simple plug and play connection. If you are going to permanently leave the handheld in the vehicle, you will need to find a factory grommet in your firewall to pass the Display CAN bus connector through and secure the excess wire away from hazards. If no factory grommets can be utilized we recommend installing one.



Note: If the 3.5" Touch Screen LCD Display needs to be unhooked from the Sniper EFI. Depress the lock tab on the male side of the connector as show in the following pictures.

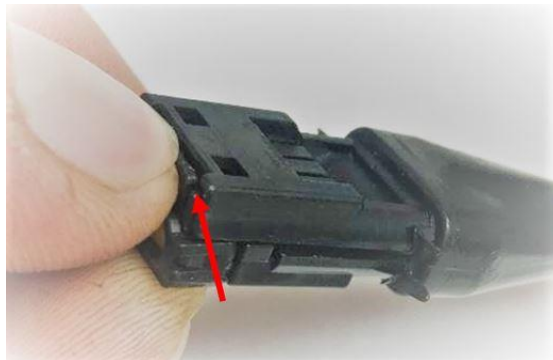
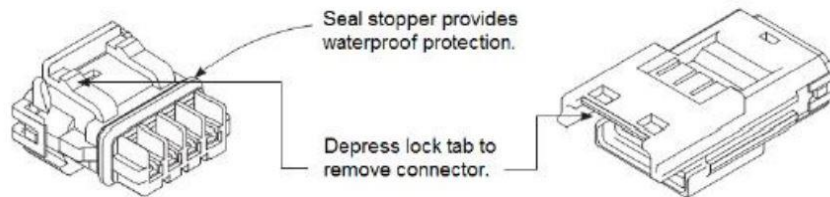

UNUSED WIRES

As you finish the installation of your Sniper EFI you will likely have unused wires. These wires need to be properly taken care of before installation is considered complete or you may end up with problems down the road. You have two options on how to properly handle these wires. The preferred option is to remove them from the connector and insert a weather proof plug in their place. The second option is to shorten the wire and properly seal the end of it to prevent shorting out.

Option 1: Pin Removal

Required tools:

Small flat head screw driver
Pin removal tool # 567-101

Procedure:

1. Use a small screwdriver or other prying tool to gently remove the protective cover from the back of the connector. NOTE: Be careful not to over extend the tabs on the cover or it will not securely fasten during re-installation.
2. Gently insert the 567-101 pin removal tool into the small slot above the pin on front of the connector. It should not require much force and you should feel the tool bottom out solidly in the connector after roughly 1/4".
3. With the removal tool still inserted fully in the cavity gently pull on the wire to remove it.
4. If you will not be putting a sealed wire back in the cavity then you should now install one of the cavity plugs supplied with tool 567-101.
5. Re-install protective cover on back of connector.

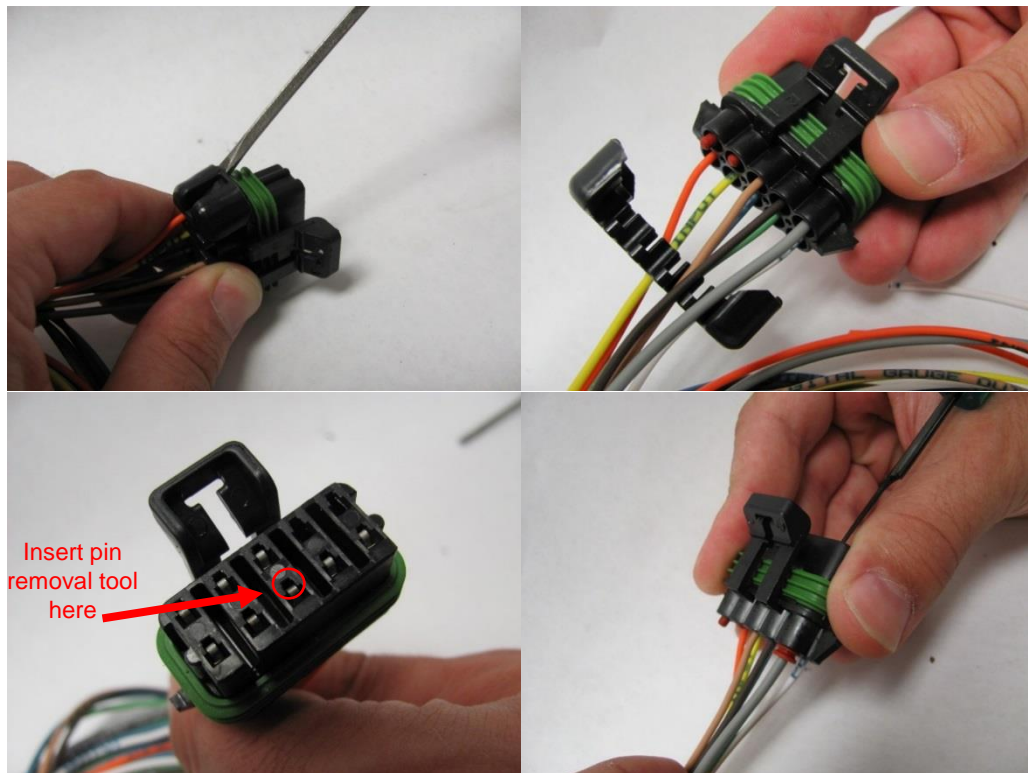

Option 2: Trim and Wrap Wire

Required tools:

Wire cutters
Adhesive heat shrink tubing
Heat source (heat gun or other)

Procedure

1. Disconnect the battery terminals.
2. Cut the end of the wire so that there is no bare copper showing. **NOTE:** Make sure you leave enough length on the wire that you will have room to crimp or solder it at a later date should the need arise.
3. Place a piece of adhesive lined heat shrink roughly 1" long over the wire.
4. With the heat shrink tubing placed so it is covering the wire with two thirds of its length apply heat to shrink the tubing.
5. Give the heat shrink a small pull to verify that it is solidly attached.

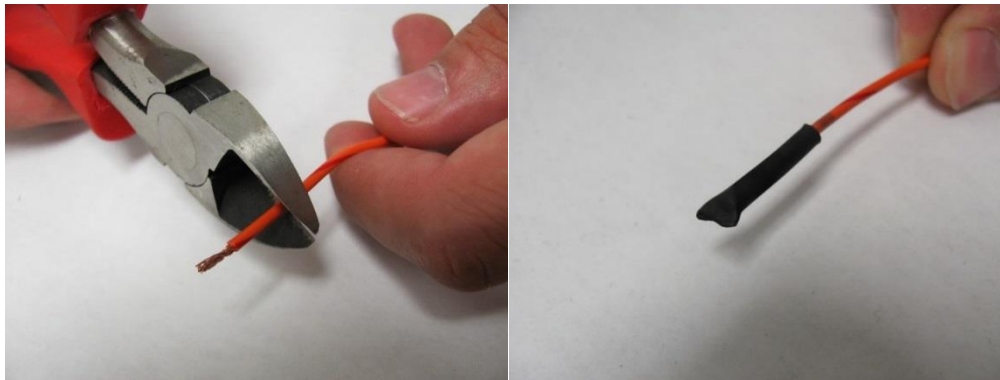

NON TIMING CONTROLLED IGNITION SYSTEM WIRING

Coil (-) [no timing control]

This Yellow wire marked "Coil-" is an RPM input wire used for the following applications:

- A stock type mechanical advance distributor with a stock inductive ignition coil. Examples of this would be any older style points distributor.
- A 1974-1981 GM large cap HEI or aftermarket replacement.

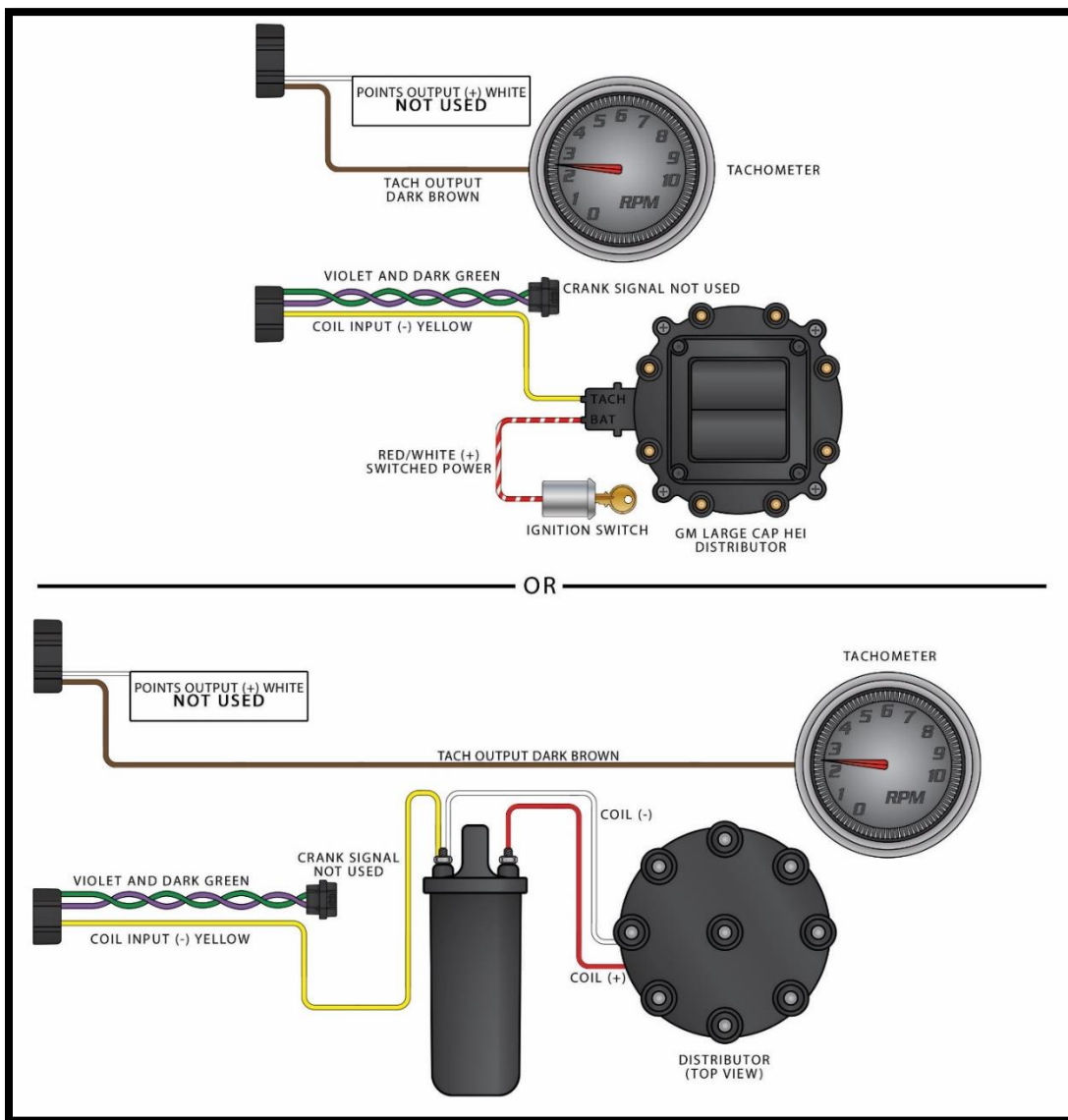

WARNING! Do NOT use this input if you are using an aftermarket Capacitive Discharge (CD) ignition system such as a MSD, Mallory, or others. The ECU will be damaged if you connect to a capacitive discharge type ignition coil.

NOTE: Using this input, the EFI will NOT control the ignition timing of the engine. The timing will be based on the distributor initial, mechanical, and vacuum advance, just like it did with a carburetor.

Ignition Box Tach Output (No Timing Control)

This requires use of the Ignition Adapter / Purple Wire that comes packaged with the main power harness.

- If you are using an aftermarket Capacitive Discharge (CD) ignition system such as a MSD, Accel, or others, you need to connect to the "Tach Out" connection or wire these systems provide. This is a 12 volt square wave output.

OPTION 2 WIRING "Tach Out":

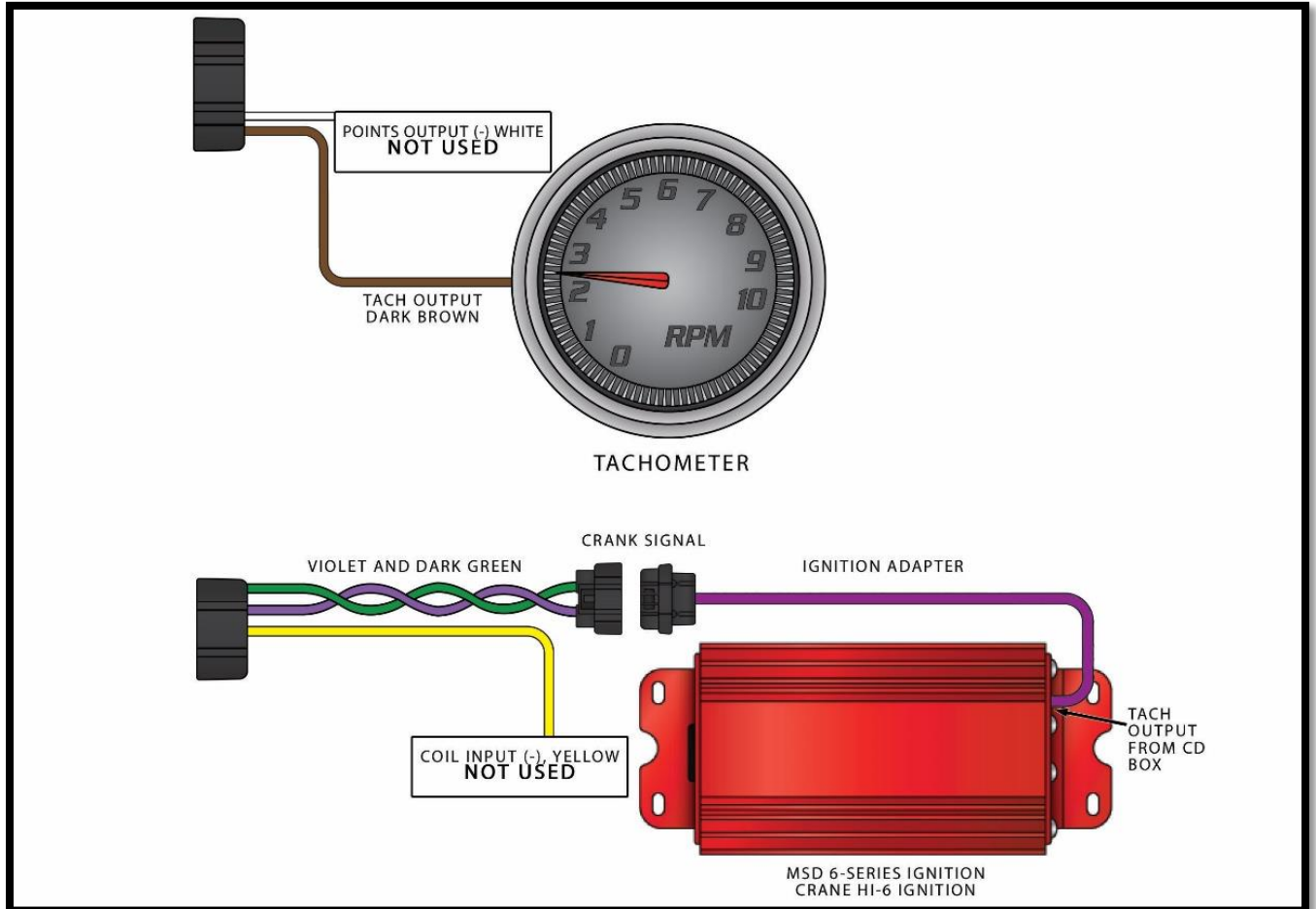

CAUTION! NEVER connect any of the EFI wires to the coil on any CD type ignition system. The ECU will be permanently damaged!

NOTE: Using this input, the EFI will **NOT** control the ignition timing of the engine. The timing will be based on the distributor initial, mechanical, and vacuum advance, just like it did with a carburetor.

For additional instructions on how to setup a Sniper EFI using a CD ignition box please reference this helpful video.

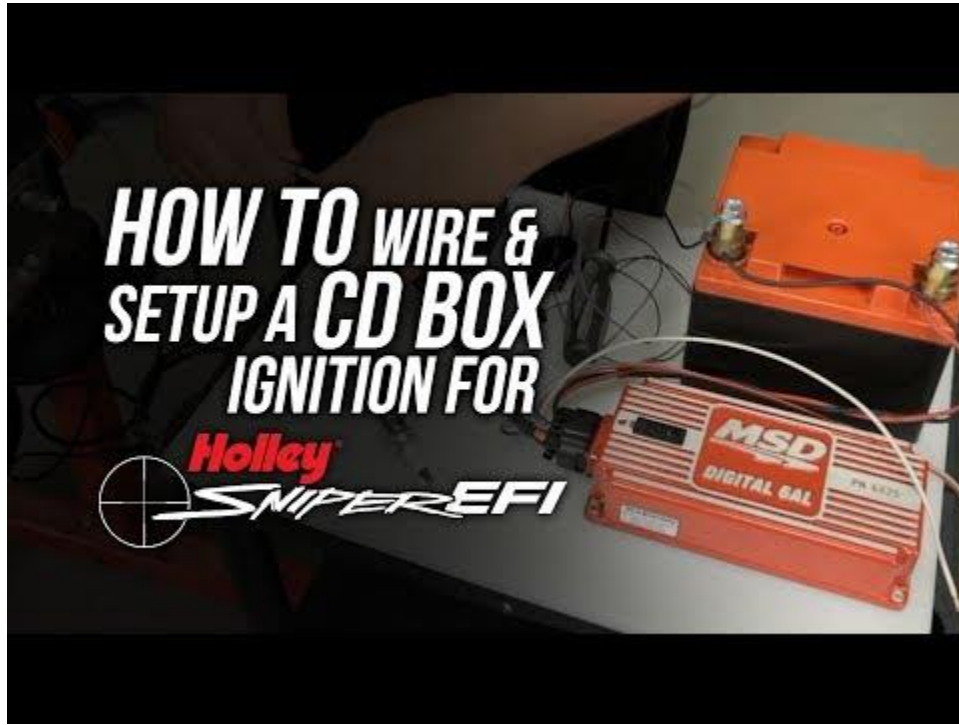

<https://www.youtube.com/watch?v=1EFiTBQ9DvI>



TIMING CONTROLLED IGNITION SYSTEM WIRING

Timing Control Preface:

The Sniper EFI has the ability to control the engines ignition timing. This is an optional feature and is NOT required for proper functioning of the fuel injection. By implementing ignition timing control through the Sniper EFI, the engine will have more precise control and an improved idle. Please refer to the following instructions on how to use this feature.

Holley recommends that those who wish to use the Sniper's timing control feature first get the engine running without timing control. Splitting the timing control into a secondary process will add very little time to the total install, but could significantly help with trouble shooting, should it be needed.

MSD (Magnetic) Distributor [Timing Control]

Before beginning, please know the following:

You will need to lock out the advance on the distributor if it is not already done.

You will need an adjustable rotor (available from MSD.)

You will need a timing light.

You will need a mark on the balancer at 15 degrees before top dead center (BTDC). If your balancer is not already marked, please follow step one in the distributor removal section to create a mark on your balancer using a paint pen.

Overview:

Sniper EFI can control timing using most common magnetic pickup distributors currently available (ex. MSD). However, you may need to make several very simple changes to the distributor which are outlined in the following section. It is very important that you "lock out" the advance built in to the distributor and install an adjustable rotor. Not "locking out" the distributor and installing an adjustable rotor as outlined in these instructions can cause the engine to run poorly or even cause engine damage.

NOTE: These instructions are directed toward MSD distributor installations. However, the same basic things need to be done with any magnetic pickup distributor before being used with Sniper EFI.

DISTRIBUTOR REMOVAL:

1. Disconnect the Battery NEGATIVE (-) cable.
2. Disconnect the power and or ground connection at the coil/coils. Tape up any non-insulated power and ground terminals to eliminate any chance of a short circuit.
3. Rotate the crankshaft in the direction of engine rotation until it reads 15 degrees before top dead center (BTDC) on the compression stroke. Take the distributor cap off and make sure that the rotor is pointing to cylinder #1. If not, rotate the crankshaft one full revolution (as the engine is not on the compression stroke).
4. If your balancer is not marked at 15 degrees, take a tape measure and measure from the 0 degree mark to the following point (mark does NOT have to be exact):

Balancer Diameter	Distance
6"	3/4"
7"	15/16"
8"	1-1/16"

5. Remove spark plug wires and all other wiring/vacuum hoses from distributor.
6. Remove distributor hold-down. Lift the distributor upwards and remove.

Distributor Lock Out Procedure

1. Remove the rotor from the distributor.
2. Remove the advance components including the springs, weights, lock nut, and the advance stop bushing from the advance assembly.
3. Remove the roll-pin from the drive gear and then remove the gear from the housing shaft.
4. Slide the shaft up approximately two inches out of the housing.
5. Rotate the shaft 180 and insert the advance stop bushing pin into the small hole on the base followed by the lock nut.
6. Tighten the lock nut down. This has now "locked out" the mechanical advance.
7. Slide the drive gear back on to the shaft and line up the dowel holes. Drive in the dowel pin to complete reassembly of your distributor.

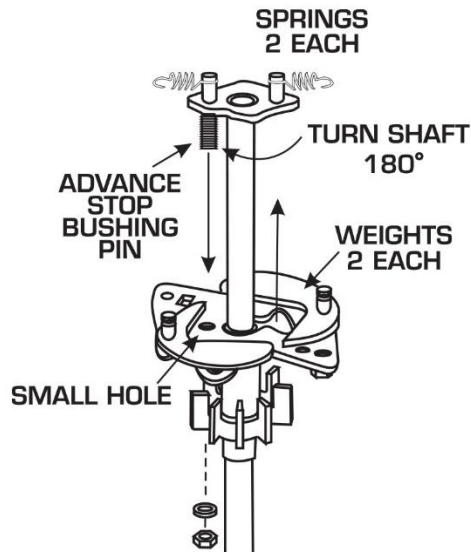

Locking out the Mechanical Advance

Vacuum Advance

If your distributor has vacuum advance it will need to be removed and locked out, use the following steps.

1. Remove the two Allen head screws that hold the advance canister.
2. Remove the snap ring that holds the magnetic pickup assembly in place.
3. Gently lift up on the mag pickup plate and slide the vacuum canister out.
4. Install the Lockout Plate in place of the canister. Install the two retaining screws.
5. Install the supplied screw and washer through the Lockout and tighten.
6. It is important to make sure the pickup plate is parallel with the housing of the distributor. If it is cocked or slanted, the paddles of the reluctor may contact the pickup. Check the clearance by rotating the distributor shaft. If necessary, use the shims that were supplied with your distributor under the Lockout hold-down to correctly position the pickup plate.

Note: If no shims were required, use one beneath the washer of the Lock-Out Hold Down Screw.

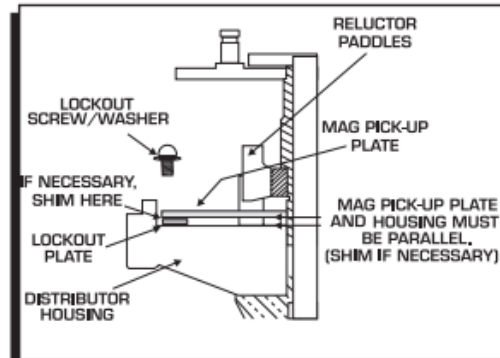
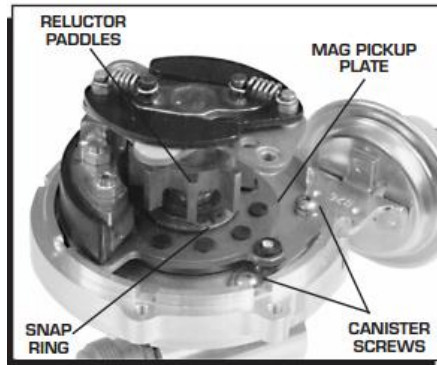

Install The Adjustable Rotor

1. Install the adjustable rotor MSD PN 84211 or PN 8421 on to the distributor shaft (See note below for applications)
2. Set the phasing of the adjustable rotor by putting it retarded (opposite of distributor rotation) 15° on the rotor indicator. See Pictures for reference.

Note: For standard GM size MSD distributors, use rotor PN 84211. For larger, Ford style MSD distributors it is recommended to fit the distributor with a smaller cap (PN 8433) and the PN 84211 rotor. If the larger cap must be used, try rotor PN 8421.

Clockwise Rotation



Neutral Rotation



Counter-Clockwise Rotation



Install The Distributor

NOTE: If the engine block or heads have been milled, make sure that the distributor will fully seat and not bind or bottom out on the oil pump drive. A quick check is to remove the distributor gasket, and make sure that the distributor still fully seats on the mounting surface. If it does not, further investigation is needed.

1. Rotate the crankshaft in the direction of engine rotation until it reads 15 degrees before top dead center (BTDC) on the compression stroke if it is not already there.
2. Install the distributor gasket on the base of the distributor. Some adhesive can be installed on the distributor side if desired to hold it in place.
3. If the engine has already been broken in/run previously and is about to be fired immediately after the distributor install, coat the gear with motor oil. If the engine is new or will sit a while before it is fired, coat the distributor gear with a moly paste or camshaft break-in lube.
4. Position the rotor contact so it is pointing to the desired direction of the #1 spark plug wire. Insert the distributor and insure that it is fully seated (**see NOTE at beginning of section**). The rotor will rotate as you insert the distributor. If it does not land in the location you desire, remove the distributor and back it up a tooth or two at a time until you are satisfied with its location. You will need to make sure the oil pump drive shaft is turned in a direction that allows for the distributor shaft to mesh with it. You may have to turn the shaft with a long screwdriver or Allen wrench to position it. **NOTE:** An engine oil priming tool is an ideal alternative to aid in aligning the oil pump drive shaft. Make sure that the drive shaft meshes and the distributor fully seats.
5. Install and snug the distributor hold down.

6. At this time you should test fit the distributor cap ensuring that the #1 cylinder terminal aligns with the rotor. You should move the body of the distributor to correct for any misalignment at this time.
7. Finish tightening the distributor hold down and install your cap and plug wires in the correct firing sequence for your engine.
8. Connect the 2 wire connector on the distributor to the matching connector on your Sniper EFI power harness. Connect the white points output wire either to the Holley coil driver module or the Points input wire on your ignition box. Refer to the following wiring diagrams to complete the wiring.
9. Refer to The Ignition Timing Check section for directions on initial startup and how to sync the distributor.

For additional and alternative instructions on how to setup a Sniper EFI using a magnetic distributor, please reference this helpful video.



<https://www.youtube.com/watch?v=oBSiveg4XCU&feature=youtu.be>

MSD (Mag) Distributor w/ Direct Drive Coil

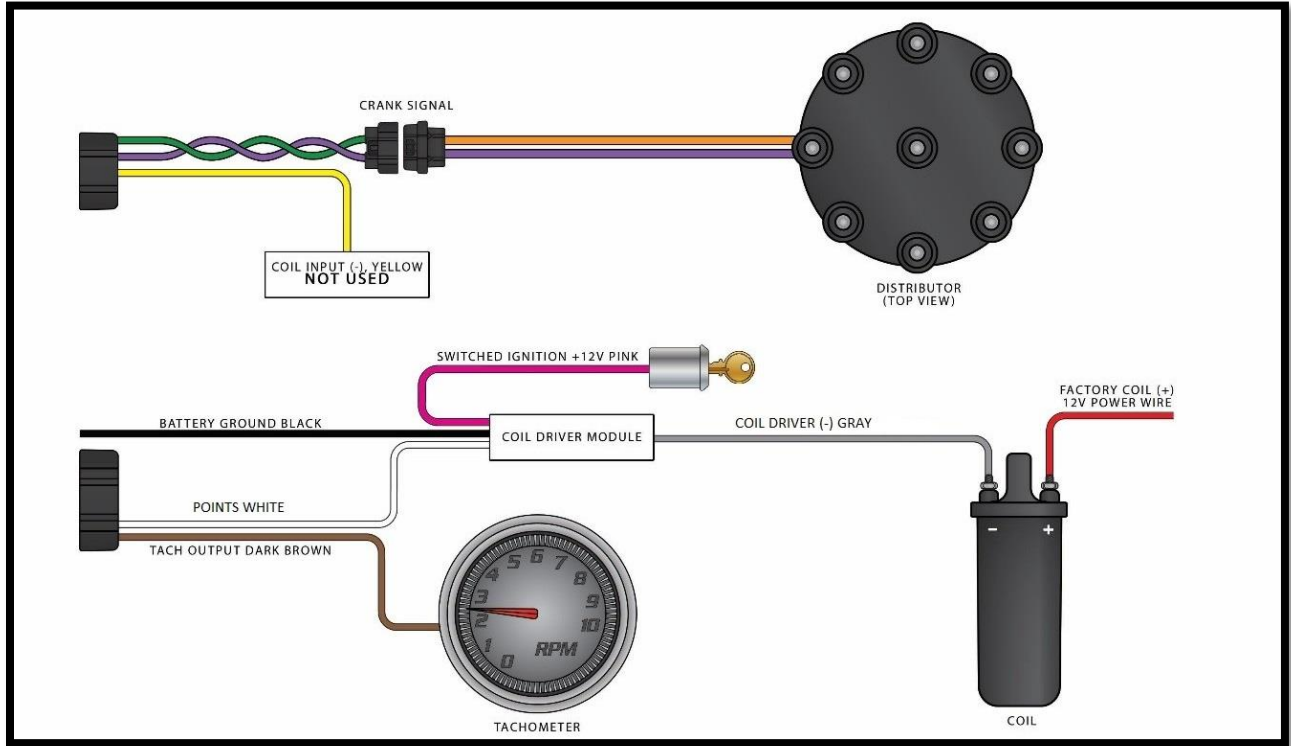

MSD (Mag) DISTRIBUTOR W/ CAPACITIVE DISCHARGE BOX (Such as MSD 6AL)

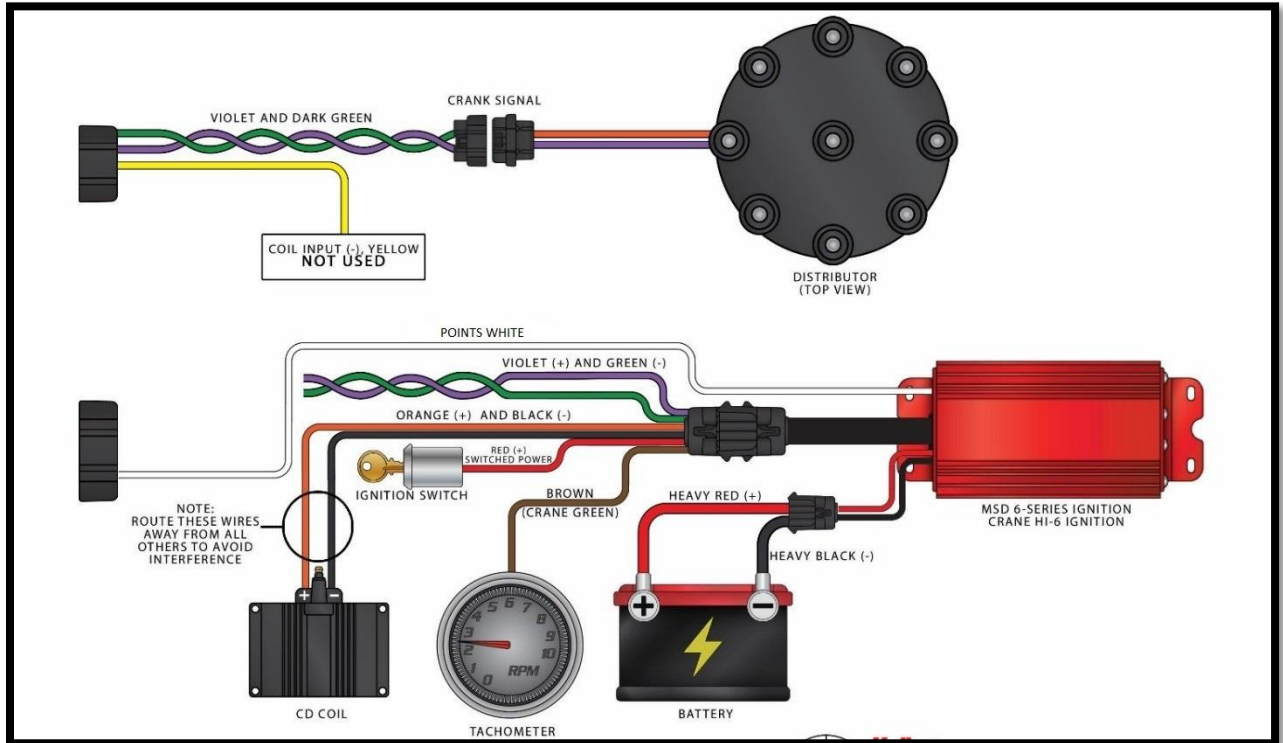

Holley Dual Sync Distributor [Timing Control]

Holley EFI Dual Sync distributors are designed to work with Sniper EFI systems with the addition of an adapter harness (Holley #558-493). The design of these distributors includes dual Hall Effect sensors for the crankshaft and camshaft signals. They can be used as just a crank speed input for applications such as Sniper EFI. The precision machined shutter wheel design ensures accurate timing, even at very high engine speeds making them an excellent choice for Sniper installations utilizing timing control.

NOTE: It is recommended that you use a Holley Dual Sync distributor if you are using a Hall Effect input for your rpm signal. However, Sniper EFI will accept a 1x per fire hall effect signal from other devices. It is up to the customer to verify compatibility and proper installation procedure with anything other than a Holley Dual Sync distributor.

NOTE: Holley distributors comes with a hardened steel distributor gear that should be compatible with all applications, other than a billet steel camshaft. If a billet steel camshaft is used, a bronze gear is recommended.

1. Prior to installing the distributor you will need to have properly setup your Sniper EFI for the Holley Dual Sync Distributor using the setup wizard. Failure to properly configure the ignition settings prior to distributor installation may cause erroneous LED readings during the alignment procedure.

Once you have run the setup wizard to properly configure your Sniper EFI, proceed to Distributor removal.

Distributor Removal:

1. Disconnect the Battery NEGATIVE (-) cable.
2. Disconnect the power and or ground connection at the coil/coils. Tape up any non-insulated power and ground terminals to eliminate any chance of a short circuit.
3. Rotate the crankshaft in the direction of engine rotation until it reads 50 degrees before top dead center (BTDC) on the compression stroke. Take the distributor cap off and make sure that the rotor is pointing to cylinder #1. If not, rotate the crankshaft one full revolution (as the engine is not on the compression stroke).
4. If your balancer is not marked at 50 degrees, take a tape measure and measure from the 0 degree mark to the following point (mark does NOT have to be exact):
5. Remove spark plug wires and all other wiring/vacuum hoses from distributor.
6. Remove distributor hold-down. Lift the distributor upwards and remove.

Balancer Diameter	Distance
6"	2-5/8"
7"	3-1/16"
8"	3-1/2"

Distributor Install:

NOTE: If the engine block or heads have been milled, make sure that the distributor will fully seat and not bind or bottom out on the oil pump drive. A quick check is to remove the distributor gasket, and make sure that the distributor still fully seats on the mounting surface. If it does not, further investigation is needed. PN 565-104 utilizes an adjustable slip collar. Ensure that it is properly adjusted to allow for proper housing and gear engagement.

1. Install the distributor gasket on the base of the distributor. Some adhesive can be installed the distributor side if desired to hold it in place.
2. If the engine has already been broken in/run previously and is about to be fired immediately after the distributor install, coat the gear with motor oil. If the engine is new or will sit a while before it is fired, coat the distributor gear with a moly paste or camshaft break-in lube.
3. Position the rotor contact so it is pointing to the desired direction of the #1 spark plug wire. Insert the distributor and insure that it is fully seated (**see NOTE at beginning of section**). The rotor will rotate as you insert the

distributor. If it does not land in the location you desire, remove the distributor and back it up a tooth or two at a time until you are satisfied with its location. You will need to make sure the oil pump drive shaft is turned in a direction that allows for the distributor shaft to mesh with it. You may have to turn the shaft with a long screwdriver or Allen wrench to position it. **NOTE:** An engine oil priming tool is an ideal alternative to aid in aligning the oil pump drive shaft. Make sure that the drive shaft meshes and the distributor fully seats.

4. Next, connect the 10 pin distributor connector to the Holley #558-493 adapter harness. **Note: If you have not already completed your installation of the 558-493 harness please do so before continuing.**
5. Reconnect the battery cable(s), leaving the coil disconnected at this time.
6. Turn the ignition key to the run position. (**DO NOT CRANK** the engine.) This will power the distributor.
7. **Distributor Alignment:** There are two LED's on the distributor circuit board. These will be used to align the distributor, by indicating when the crank and cam sensors are being triggered. The crank and cam LED's are noted in **Figure 1** below.

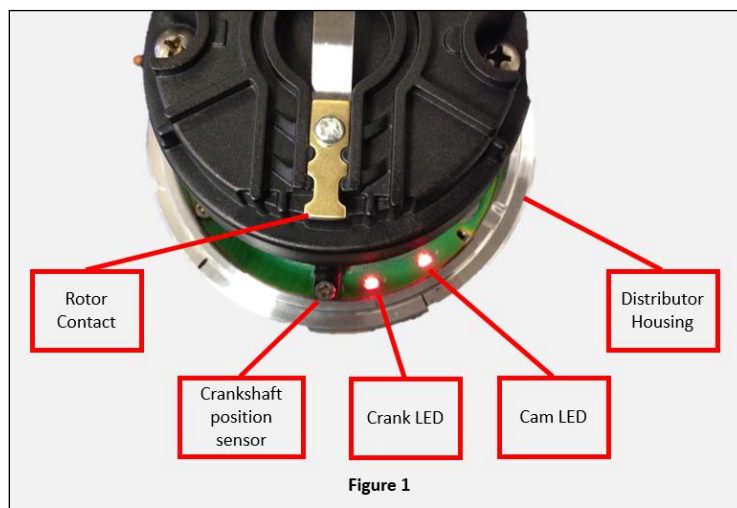

NOTE: All adjustments will be made by rotating the distributor housing only. **DO NOT ROTATE THE CRANKSHAFT** as it should remain at 50 degrees BTDC.

LED (**ON**) represents digital falling. LED (**OFF**) represents digital rising

Your distributor will rotate clockwise or counter-clockwise. You will need to determine the proper direction of rotation before proceeding.

Engine Family	Rotor Rotation
Small/Big Block Chevy	Clockwise
Chrysler Small Block	Clockwise
Ford 351W	Counter-Clockwise
Ford 302	Counter-Clockwise
BB Chrysler Wedge	Counter-Clockwise
Ford FE	Counter-Clockwise
Oldsmobile	Counter-Clockwise
Pontiac	Counter-Clockwise

Clockwise Rotor Rotation: (See chart to determine what direction your distributor rotates.)

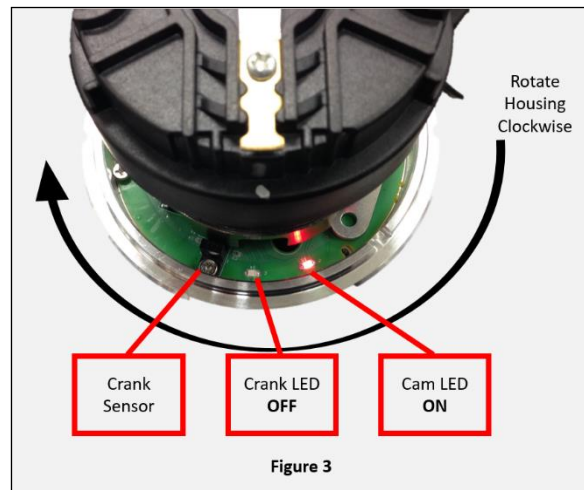
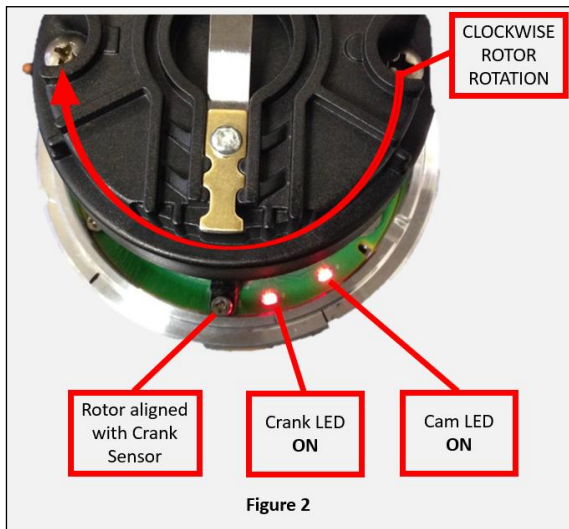

For engines that have the rotor rotating **clockwise**, turn the housing until the rotor contact is pointed at the black crank position sensor (**Figure 2**). Both the cam and crank LED should be illuminated (**ON**).

Slowly turn the housing **clockwise** until the Crank LED goes **OFF** (**Figure 3**).

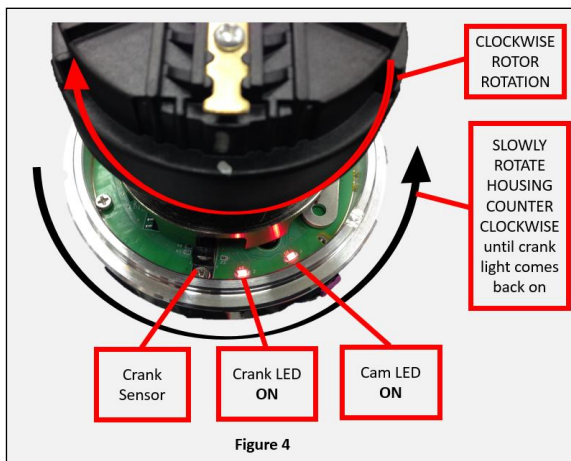

Then slowly turn the housing **counter-clockwise** until the Crank LED comes back **ON** (**Figure 4**). Stop at this point. This will position the distributor close to where it needs to be. Install and snug the distributor clamp down at this point.



The relationship between the crank sensor, shutter wheel opening, and rotor in the picture above should match what is installed in your engine.

Once these steps are completed, the rotor will be pointing to the cylinder #1 terminal on the distributor cap (ensure the engine is still at 50 degrees BTDC on the compression stroke on cylinder #1). Note which position this is on the distributor cap. Install the cap and install the #1 plug wire. Install the rest of the plug wires based on the engine's firing order and rotor rotation. Reconnect the coil power and ground connection.

Counter-Clockwise Rotor Rotation: (See chart to determine what direction your distributor rotates.)

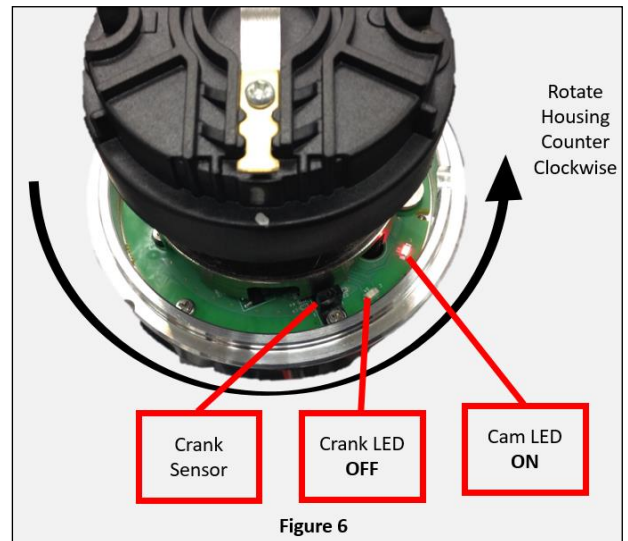
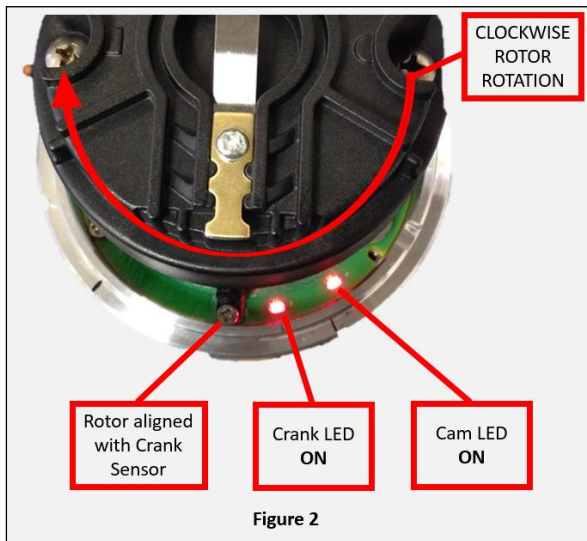

For engines that have the rotor rotating **counter-clockwise**, turn the housing until the rotor is pointed at the black crank position sensor (**Figure 5**). Both the cam and crank LED should be illuminated **ON**.

Slowly turn the housing **counter-clockwise** until the Crank LED goes **OFF** (**Figure 6**).

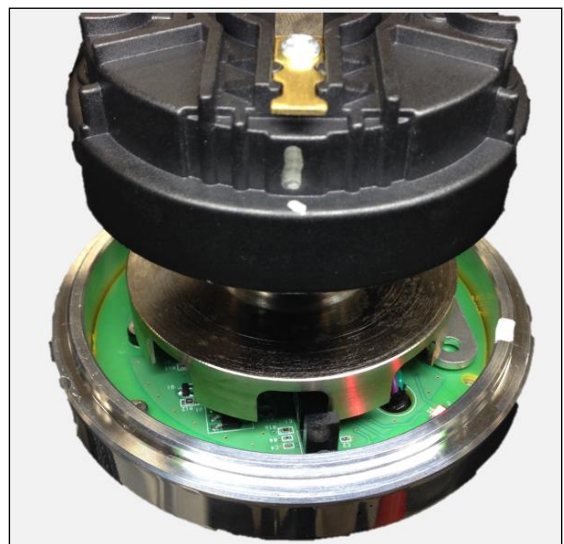
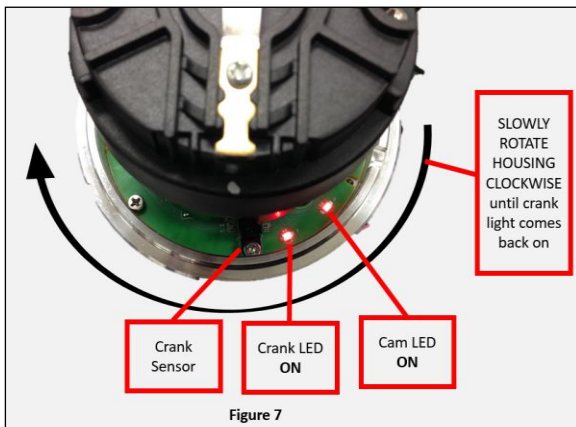

Turn the housing **clockwise** until the Crank LED comes back **ON** (**Figure 7**). Stop at this point. This will position the distributor close to where it needs to be. Install and snug the distributor clamp down at this point.

The relationship between the crank sensor, shutter wheel opening, and rotor in the picture above should match what is installed in your engine.

Once these steps are completed, the rotor will be pointing to the cylinder #1 terminal on the distributor cap (ensure the engine is still at 50 degrees BTDC on the compression stroke on cylinder #1). Note which position this is on the distributor cap. Install the cap and install the #1 plug wire. Install the rest of the plug wires based on the engine's firing order and rotor rotation. Reconnect the coil power and ground connection.

For additional instructions on how to setup a Sniper EFI using a Holley Dual Sync Distributor, please reference this helpful video.



https://www.youtube.com/watch?v=O5_089Q39CA

WIRING W/ Holley Dual Sync Distributor and Direct-Drive Coil

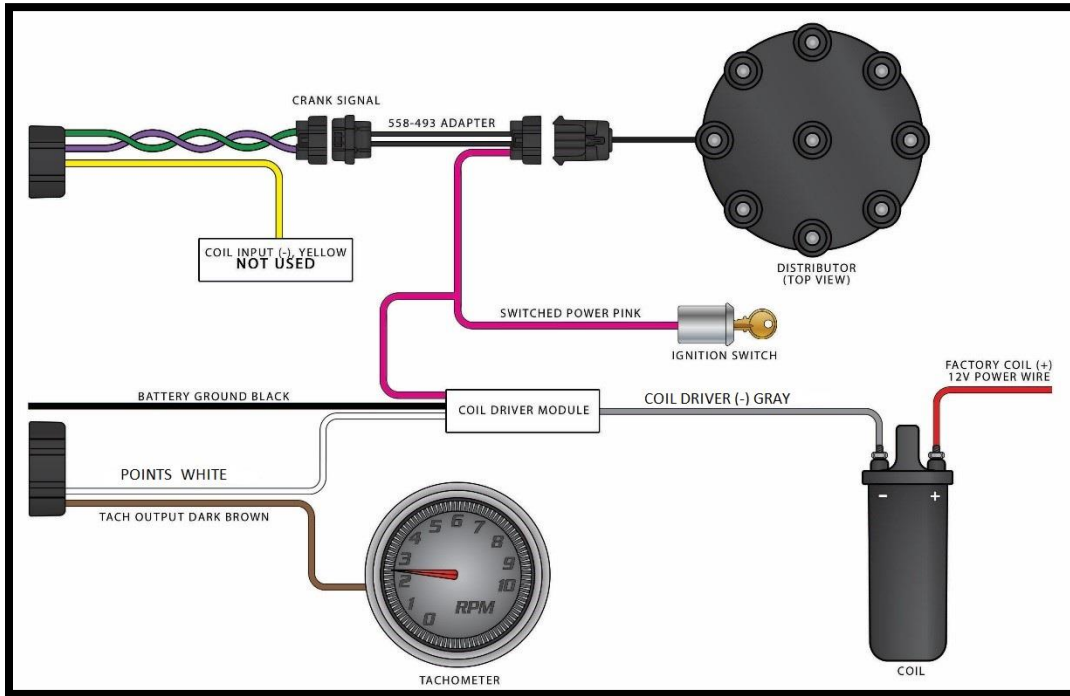

WIRING W/ Holley Dual Sync Distributor and CAPACITIVE DISCHARGE BOX (Such as MSD 6AL)

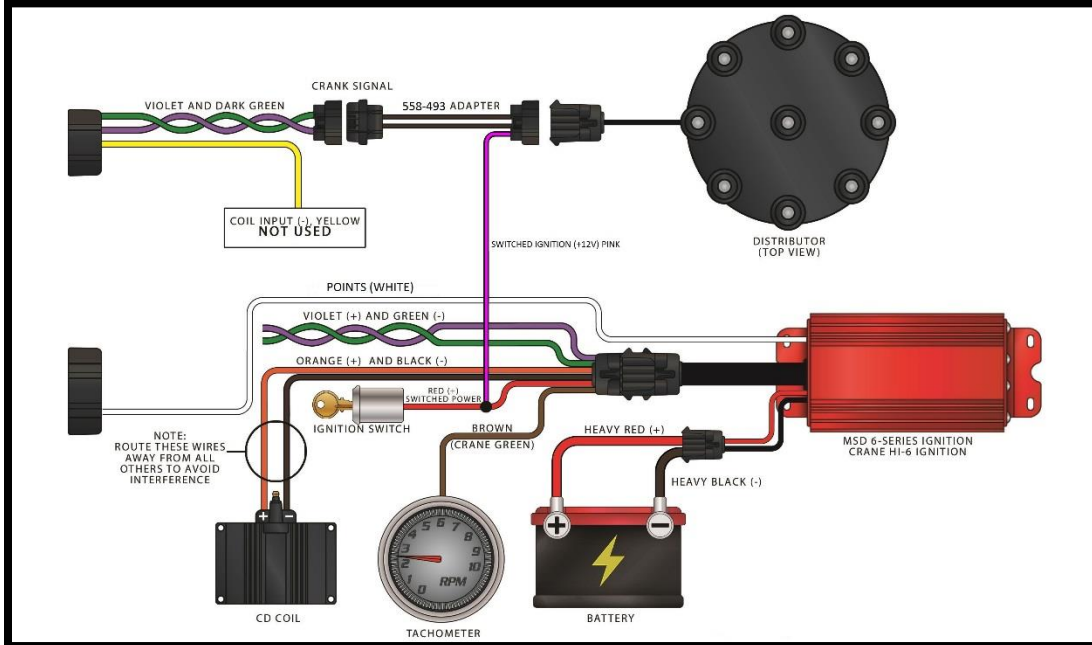

HOLLEY DUAL SYNC DISTRIBUTOR PINOUT:

If custom wiring the distributor, use the following pinout:

Connector Location	Channel	Wire Color
A	Crank Signal	Purple/White
C	Signal Ground	Green
E	Switched +12V	Red

HANDHELD NAVIGATION

Possible Screens

The 3.5" handheld utilizes a touch screen display. All navigation is done through "touching" an icon or button on the screen. The following is an overview of the different types of adjustment screens that are used in the display, and that may be utilized when tuning or making selections.

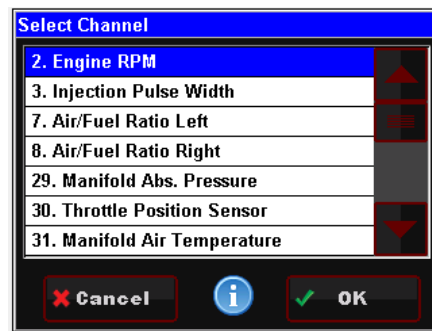
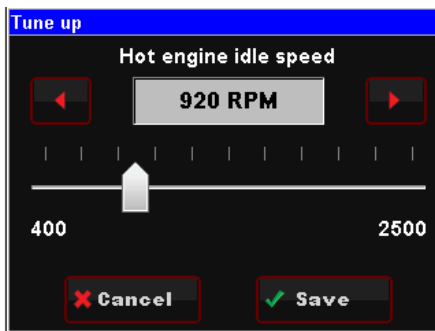

Slider Bar: Slide the bar left or right with the stylus, or use the right and left arrow keys for fine adjustment

List: Use the scroll bar on the right hand side of the screen to view all list entries. Touch the desired list item and click 'OK' to make a selection

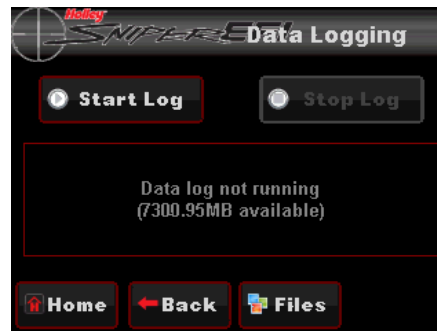
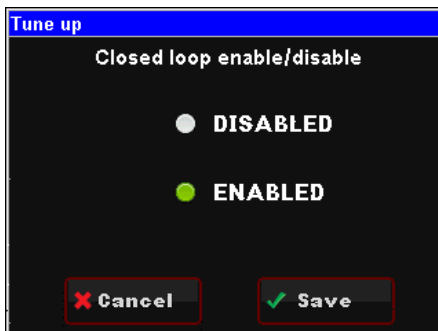

Radio Button: Touch the desired list item to select it

On Screen Prompts: Follow the on screen text and use on the screen instructions

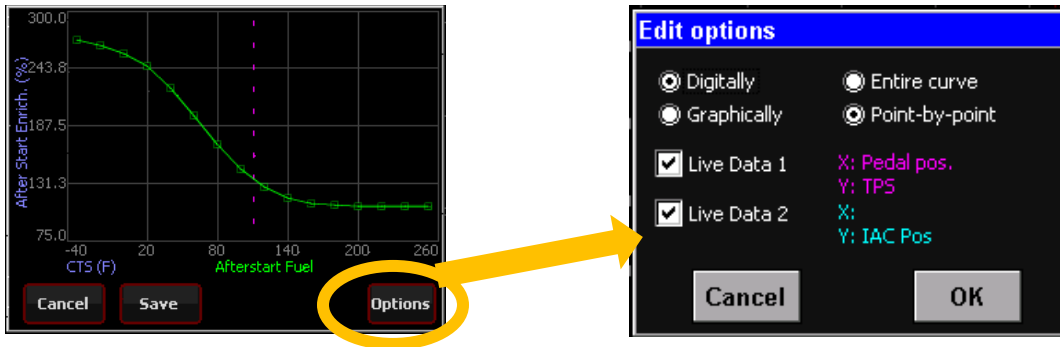

Graph Options:

Digitally: Selecting this option enables slider bar adjustment of individual data points on the graph or the entire curve.

Graphically: Selecting this option enables single point or whole curve adjustment. A stylus may be used to select and drag data on the graph screen.

Entire Curve: Selecting this will 'lock' all the data points together allowing the entire curve to be shifted up or down

Point by Point: Selecting this will allow point by point curve adjustment for fine tuning

Live Data 1 & 2: This will enable live telemetry on the graph screen making fine tuning easier

The Key Icon next to a tuning parameter means that the ignition must be cycled for the tuning change to take effect.



INITIAL EFI SETUP



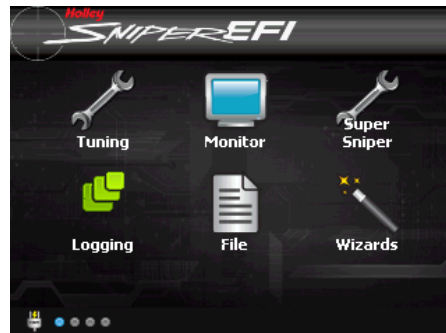

Calibration Wizards



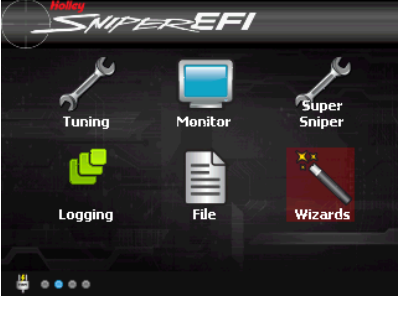

Turn the ignition key to the “run” position. This should apply 12+ volts to the Pink wire in the ECU harness and will power the Sniper EFI Touch Screen LCD. The Home Screen (**figure below**) should appear.

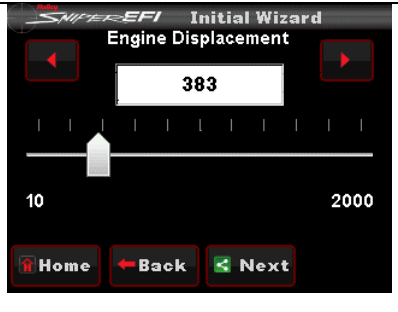

The Home screen contains icons which will navigate to different functional features of the 3.5” Touch Screen. These features will be discussed in detail throughout the main manual. The 3.5” Touch Screen will not display sensor parameters until a base calibration has been put in the unit using the Wizard.

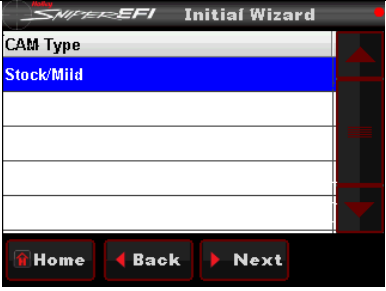
To Run the Wizard see the following:

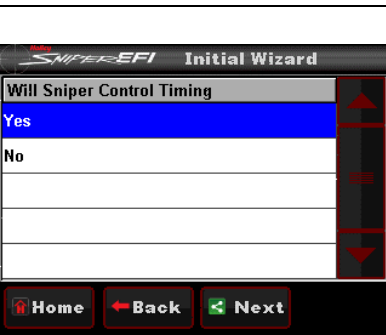
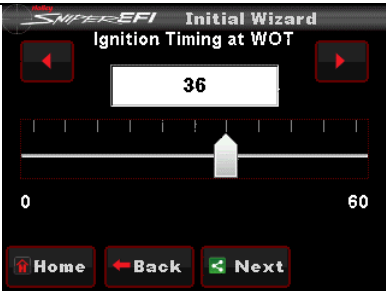
<p>STEP 1</p>	 The image shows the main menu of the SNIPER EFI software. It features a dark background with the 'SNIPER EFI' logo at the top. Below the logo are six icons arranged in a 2x3 grid: 'Tuning' (wrench), 'Monitor' (computer monitor), 'Super Sniper' (wrench), 'Logging' (green squares), 'File' (document), and 'Wizards' (magic wand). The 'Wizards' icon is highlighted with a red border.	<p>Select WIZARD from the main menu</p>
<p>STEP 2</p>	 The image shows the 'Initial Wizard' screen with the title 'Initial Wizard'. The main heading is 'Select Sniper TBI Type'. There are two list items: '550-510/511/516 4-inj 4150' and '550-849/850/851 2-inj 2300'. The second item is selected and highlighted in blue. At the bottom, there are three buttons: 'Home', 'Back', and 'Next'.	<p>- Select your Sniper system type -Press Next</p>
<p>STEP 3</p>	 The image shows the 'Initial Wizard' screen with the title 'Initial Wizard'. The main heading is 'Number of Cylinders'. There are three list items: '4', '6', and '8'. The '8' item is selected and highlighted in blue. At the bottom, there are three buttons: 'Home', 'Back', and 'Next'.	<p>Select the number of cylinders your engine has -Press Next</p>
<p>STEP 4</p>	 The image shows the 'Initial Wizard' screen with the title 'Initial Wizard'. The main heading is 'Engine Displacement'. There is a slider bar with a white arrow pointing to the value '383'. The scale ranges from 10 to 2000. At the bottom, there are three buttons: 'Home', 'Back', and 'Next'.	<p>Use the slider bar to input the displacement of your engine -Press Next</p>
<p>STEP 5</p>	 The image shows the 'Initial Wizard' screen with the title 'Initial Wizard'. The main heading is 'Target Idle Speed'. There is a slider bar with a white arrow pointing to the value '850'. The scale ranges from 400 to 2500. At the bottom, there are three buttons: 'Home', 'Back', and 'Next'.	<p>Use the slider bar to set your desired HOT idle speed. This is the RPM the Sniper will target at coolant temperatures above 160 °F -Press Next</p>

<p>STEP 6</p>		<p>Select your camshaft type:</p> <ul style="list-style-type: none"> • Stock/Mild = This selection will work well on most applications equipped with stock or “street performance” camshafts. Choose Stock/Mild if you are unsure of your camshaft specs <p>-Press Next</p>
<p>STEP 7</p>		<p>Select your ignition type:</p> <ul style="list-style-type: none"> • Coil (-) [no timing control] <i>Skip to Step 10</i> • CD Ignition Box [no timing control] <i>Skip to Step 10</i> • Magnetic [ECU Controlled Timing] <i>Proceed to Step 8</i> • Holley Dual Sync [ECU Controlled Timing] <i>Proceed to Step 8</i> <p>-Press Next</p>
<p>STEP 8</p>		<p>Choose whether your Sniper will control engine timing if using a Timing Control Ignition Type. For more details on this feature, refer to the Ignition Wiring Section of the Reference Manual</p> <ul style="list-style-type: none"> • Yes <i>Proceed to Step 9</i> • No <i>Skip to Step 10</i> <p>-Press Next</p> <p>Note: We highly recommend first starting the engine with one of the two NON-Timing Control Ignition types shown in step 8 for your first start-up!</p>
<p>STEP 9</p>		<p>Use the slider bar to set your desired ignition timing at Wide Open Throttle (WOT)</p> <p>-Press Next</p>
<p>STEP 10</p>		<p>After answering all questions in the Wizard, your calibration will be created. Press the “Start” button to send the calibration to the ECU. Once this process is completed, you will see a screen indicating the file has been uploaded. Once file is uploaded the Ignition Needs to be cycled.</p>



Sensor Verification

Before starting the vehicle, verify that all of the sensors are reading properly. To do this, turn the ignition key off, and cycle it back on. You should hear the fuel pump come on and run for 5 seconds.

Fuel Prime occurs 2.5 seconds after key-on (which is also the amount of time it takes for the 3.5" touch screen to load). If you quickly turn the ignition key without waiting for the full 2.5 seconds, the prime will not occur and it may take longer for the engine to start.

Caution! Multiple key cycles without firing the engine could potentially cause a flooded condition. If Ignition Box or Distributor has the ability to send rpm signals with each power cycle on (such as a Tach Sweep or Rev Limiter Verification), these settings must be disabled. Failure to disable these features may result in engine failure. Reference ignition system instructions.

Note: This is a great time to check for fuel leaks and verify fuel pressure.

On the HOME SCREEN, select the MONITOR icon, then select the "Monitors" screen. You will see an icon named "Initial Startup". Select this. With the key on and the engine off, these sensors should read as follows:

- **Engine RPM** – This gauge should show "Stall!", once you begin cranking the engine it will show actual engine RPM
- **TPS** (Throttle Position Sensor) – Should read 0. Slowly depress the throttle to wide open. It should read between 85 and 100% at wide open throttle. If it does not, please verify your throttle linkage is allowing full travel of the throttle arm.
- **MAP** (Manifold Air Pressure Sensor) – Should read from 95-102. At high elevations it could read as low as 75.
- **CTS** (Coolant Temperature Sensor) – reads engine temperature.
- **IAC Position** – See Idle Setting/Throttle Plate Setting section in this manual.
- **Battery** – Will read battery voltage. Should be 12.0 volts minimum.

If ANY of these sensors are not reading properly, it must be resolved before the engine is started.

Initial Startup	
Engine RPM	Stall!
TPS	0 %
MAP	101 kPa
CTS	85 F
IAC Position	77 %
Battery	12.4 Volts

Home ← Back All on Gauges



Prestart Checklist

Before starting the engine, double check for leaks, proper wire routing, any wiring hazards, loose nuts and bolts. This is a great time to visually inspect the overall Sniper EFI install.

- Verify Wiring. ECU is powered directly at the battery and the battery is fully charged.
 - o Pink Wire is attached to a 12V+ switched source that has voltage during cranking and run positions of the ignition. Verified with a Multimeter
 - o Coil Negative Ignition setups have the Yellow Wire on the negative terminal of the Coil
 - o CD Box Ignition setups have the Tach Output Wire from CD box is connected to the purple wire in the Sniper EFI Harness, using the Tach Signal Adapter
- Handheld powers up
- Wizard has been run with correct Non Timing Controlled Ignition setup chosen
- Fuel Pressure has been Verified to be between 55-60 PSI
- All wiring has been tied away from potential hazards such as the exhaust and fans and pulleys

First Startup

With the handheld still on the “Initial Startup” screen, crank the engine and look at the RPM parameter. It should change to “Syncing”, indicating the ECU is syncing with the RPM signal for an instant, then show an RPM signal. The engine should fire and run and come to an idle.

If the engine does not start please use the flow chart at the end of this Manual. If issue still continues then Call Holley Tech service for advice.

If the engine starts but is idling too low and appears to be struggling for air, you may have to open the throttle body idle speed screw at this time. A loud whistling may be experienced at idle if the throttle blades need be opened further.

After Startup

Once the vehicle has started, double check for any fuel or coolant leaks. While the engine warms up look at some other parameters to make everything is operating properly. Go into the MONITOR, MULTI GAUGE, and select the “AIR/FUEL RATIO” Icon.

- **AFR, A/F** – This will show the air/fuel ratio the wideband oxygen sensor is reading. The Closed Loop Compensation should be adding or subtracting fuel all the time such that the AFR Left should always be close to the Target AFR value.
- **Target Air/Fuel Ratio** – This is the target AFR (air/fuel ratio) the ECU is trying to maintain. This will vary depending on the engine speed and load.
- **Coolant Enr, %**: Indicates the amount of enrichment based on the coolant temperature. 100% is zero enrichment and will not reach this point until the engine is 160 Degree F. Engine will not go into learn mode until this is at 100%.
- **CL Status** – Indicates whether the engine is “Closed Loop” or “Open Loop”. Closed Loop indicates that the ECU is adding or subtracting fuel to maintain the target air/fuel ratio. The Sniper EFI calibrations are such that the system should be operating closed loop almost all of the time.
- **CL Comp, %** – This is the percentage of fuel that the ECU is adding or subtracting to maintain the target air/fuel ratio at any specific moment. A value with a minus (-) sign in front indicates the ECU is removing fuel. A value with no minus sign indicates the ECU is adding fuel. When in open loop operation, this will always stay at 0%.
- **Learn Status** – This indicates the status of the Sniper EFI “Self Tuning” operation (Learn Status). The system will populate the learn table as you drive around. There are several conditions that must occur in order for the Self Tuning to occur. The engine temperature must exceed 160° F. The system must be operating in a closed loop mode, and the Self Tuning must be enabled. The base Sniper EFI calibrations have the Self Tuning enabled. Once the engine coolant temp reaches 160° F, the Self Tuning should be active. The Learn Stat will show “NoLearn” when Self Tuning is not active and “Learn” if Self-tuning is active.
- **Current Learn, %** - This is the percentage of fuel the ECU is adding or subtracting to the base fuel map. This is not a progress bar. A value with a minus (-) sign in front indicates the ECU is removing fuel from the base fuel map. A value with no minus sign indicates the ECU is adding fuel to the base fuel map. Typical readings are between -20% - 20%, but can be higher or lower depending on the application that the Sniper EFI is installed on.
- **Inj PW, msec** – Indicates the injector pulsewidth. This will vary depending on the engine speed and load.
- **RPM, rpm** – Indicates the frequency that the engine is running at
- **Fuel Flow, lb/hr** – Indicates the amount of fuel being injected into the engine at any given time. This will vary depending on the engine speed and load.

If any of these parameters are not showing a proper value, find out why before further driving the vehicle.

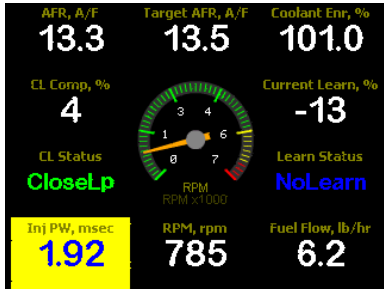

AIR/FUEL RATIO Multi-Gauge
Engine below 160° F (NoLearn)

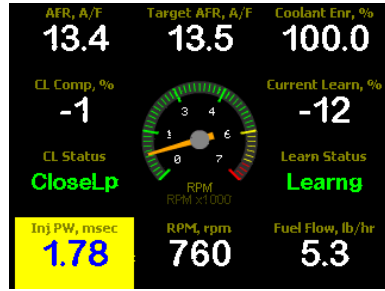

AIR/FUEL RATIO Multi-Gauge
Engine above 160° F (Learn)

Ignition Timing Check (without Timing Control)

Verify with a timing light that the timing is set to an appropriate value for particular engine combination. Adjust as necessary. It is critical to have the timing set correctly before the car has been driven with the Sniper EFI. Many drivability and idle issues can be avoided with a properly timed engine.

Ignition Timing Check (ECU Controlling Timing)

Have a timing light handy as the first step will be positioning the distributor.

1. Turn the key **ON** to power the system and go to Tuning -> System -> Static Timing. This screen allows you to set the distributor exactly where the Sniper ECU needs it to be positioned to operate the timing.
2. Start the engine, then move the slider on the screen to 15°, then press SET. Now using the timing light, move the distributor until you see 15° BTDC on the balancer. Tighten the hold down clamp.
3. Leave the Static Timing screen by pressing CLOSE. This will take you back to the Home screen and the Sniper will now be controlling the ignition timing. It is important to note that you will not see accurate timing at idle speed when viewing with a timing light. This is due to ECU calculations. If you rev the engine off idle, the timing will appear correctly.
4. From the Spark Screen which is located Tuning -> Basic -> Spark, you can adjust the Idle, C369*ruise, WOT and Cranking timing settings. It is HIGHLY suggested that a timing map using the Sniper EFI PC Software is built for the particular engine the Sniper EFI is controlling timing on. The Timing map built using the handheld is very basic and each engine will perform much more optimally with a timing curve built for the specific engine combination.

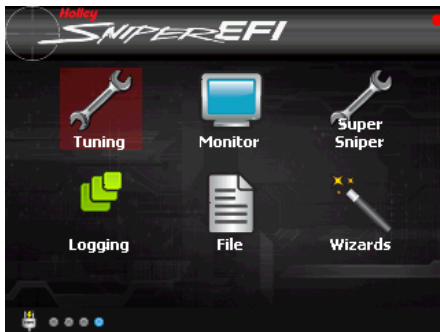

Step 1

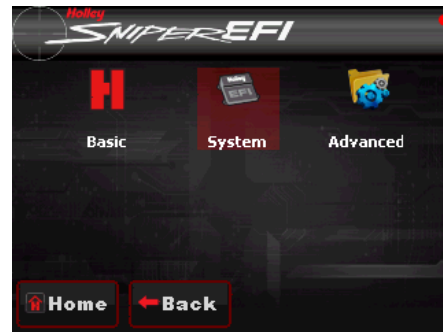

Step 2

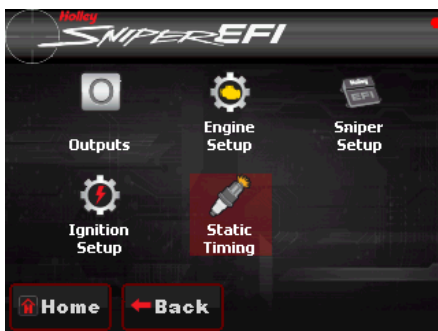

Step 3

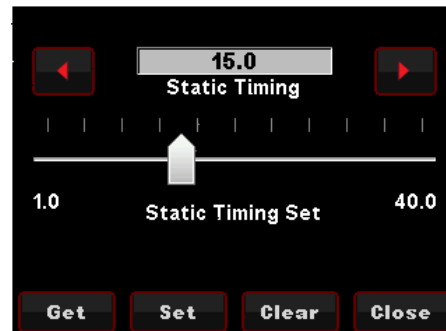

Step 4

THROTTLE BLADE ADJUSTMENT

Once engine has warmed up above 160 degrees the throttle blade angle can be set. It is critical for the engine to be above 160 degrees F before setting the throttle blade angle.

From the Home screen, Select the Tuning Icon. Then Select Basic and then the Basic Idle Icons. This will allow you to set your basic Engine Idle Speed when engine is up to temperature. Select the desired idle by sliding the slider to desired value and press Save.



Step 1

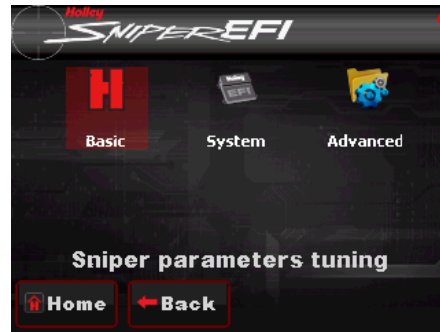

Step 2



Step 3

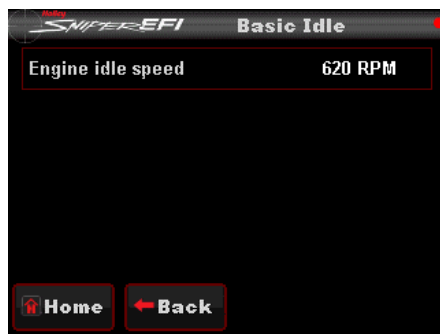

Step 4

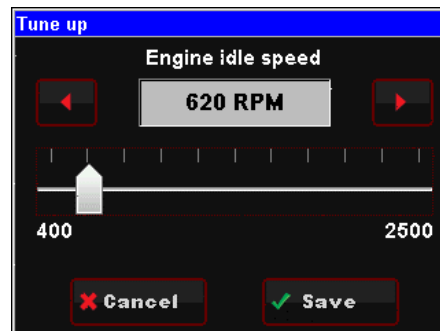

Step 5

With the engine running, Select "Monitors" tab from the main menu, then select the "Multi-Gauge" tab, then the "Sensors" tab. In the lower left hand corner "IAC Pos,%" will be displayed. This value needs to read between 2-10% with the engine running at idle in park without an AC on, if equipped. If the value is 0 the blades need to be closed until it reads between 2-10%, if the value is higher than 10% the blades need to be opened until it reads between 2% and 10%.

Once the value is between 2%-10% for the desired idle RPM the throttle blade angle is set correctly. While adjusting the blades to the correct IAC Position %, the TPS reading may change. This is normal and after an ignition power cycle the TPS will read zero again.

SYSTEM SETUP

Ignition System Setup

Once the system is up and running with a specific ignition type the configuration has been set. **If the ignition type is physically changed the setting in the configuration needs to be changed as well.**

From the Home Screen, Select the Tuning Icon. Then Select the System Icon. Next Select the Ignition Setup Icon. Here is where you can change you Ignition settings.



Following are examples of what the specific default ignition configurations look like in the handheld.

Coil -



Magnetic

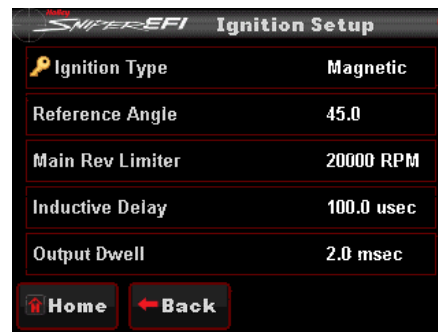

CD Box



Holley Dual

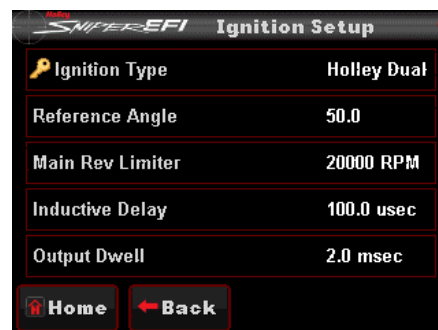

BASIC TUNING

The Sniper EFI allows the user to perform some basic tuning changes to help optimize mileage, drivability, and performance. The tuning is split up into “Basic Tuning” and “Advanced Tuning”. This part of the manual covers the basic tuning. Please reference the Advanced Tuning section for details about settings under the Advanced Icon.

The Basic Tuning allows changes to the Air/Fuel Ratio's, changes to Ignition Timing if the Sniper is configured to as a Magnetic distributor or a Holley Dual Sync ignition setup , Closed Loop and Learning, and basic idle speed. The Advanced Tuning is typically not needed. It allows changes to some items that are less commonly used. These parameters require some understanding before changing. From the HOME SCREEN, select TUNING, and BASIC. There are 4 areas you can modify, BASIC FUEL, FUEL LEARN, BASIC IDLE, & SPARK these are reviewed below.

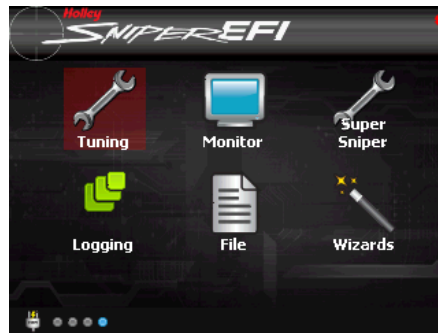
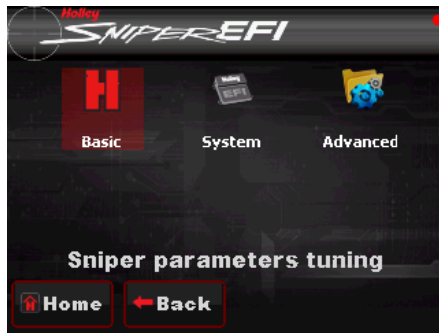

Basic Fuel

Selecting BASIC FUEL brings up the following menu:

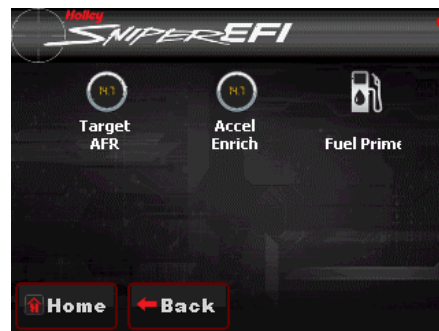

Target AFR

Allows changes to the Target Air/Fuel ratio at idle, cruise, and wide open throttle (Figure 23). The following are typical values and some tuning notes.



Idle Air/Fuel Ratio – Typically between 13.5 and 15.0. Engines with larger cams may need a richer setting for smoothest idle.

Cruise Air/Fuel Ratio – Typically between 13.5 and 15.5. Engines with larger cams may need a richer setting for smoothest operation.

Wide Open Throttle Air/Fuel Ratio (WOT) – Typically between 12.0 and 13.0. Running richer may reduce power. Running leaner may reduce power or cause potential engine damage.

NOTE: The Target Air/Fuel setting between IDLE, CRUISE, and WOT is blended together automatically. Consequently, the air/fuel you see on the MONITOR screen, may not be exactly what you set for the settings. Changing these settings raises or lowers the “curve” of that specific area.

Acceleration Enrichment

Changes the “accelerator pump” function of the fuel injection. Raising the number increases the amount of fuel added when the pedal is pushed. Lowering the number decreases the amount of fuel added when the pedal is pushed. It is highly recommended NOT to change this until the ECU is allowed to perform self-tuning.

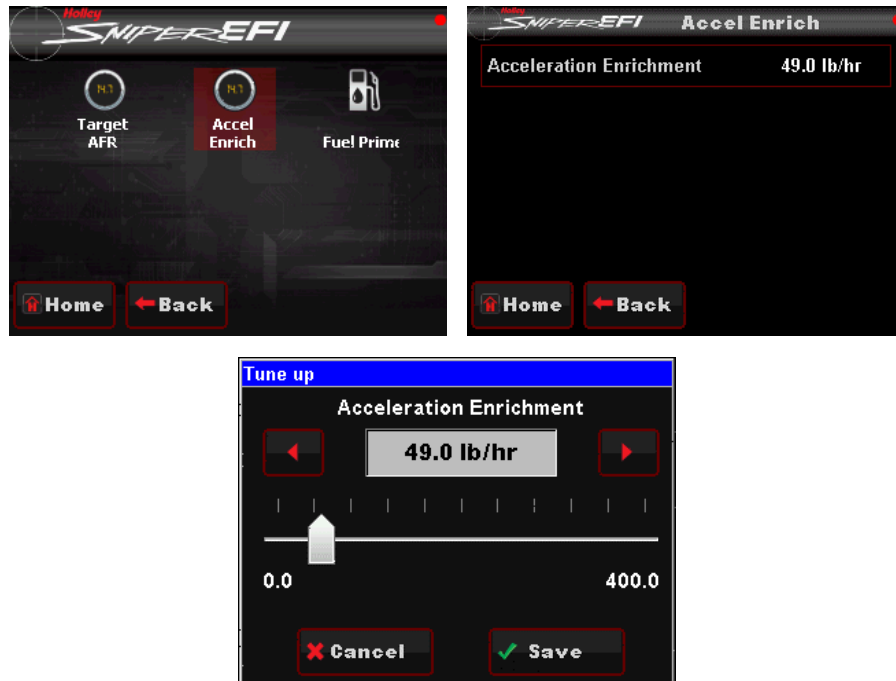

Fuel Prime

Fuel prime is an option that is enabled by default in all of the base calibrations. The fuel prime function injects a small shot of fuel into the intake manifold when the ignition is turned on, wetting the intake and allowing the engine to start much quicker. The amount of fuel is based on the engine. This amount of fuel can be increased or decreased by changing the “Percent” value. If the engine seems flooded reduce this value, if the engine seems to want more fuel, increase it. Experiment for best results. Typically this value will range from 75-150% with a maximum of 200%.

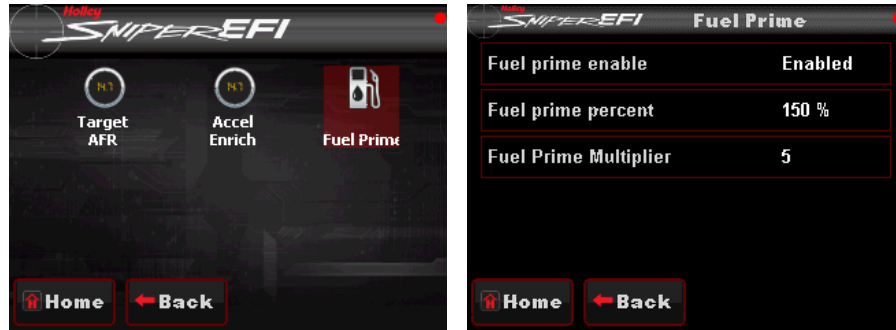

NOTE: This only injects fuel once at key-on, and will not do it again until the engine has run. This fuel prime occurs 2 ½ seconds after key-on. If you quickly turn the ignition key without waiting for 2 ½ seconds, the prime will not occur and it may take longer for the engine to start.

Closed Loop Enable/Disable

The Closed Loop Enable / Disable menu turns the Closed Loop AFR correction “On” and “Off”. It is advised to always have this enabled.

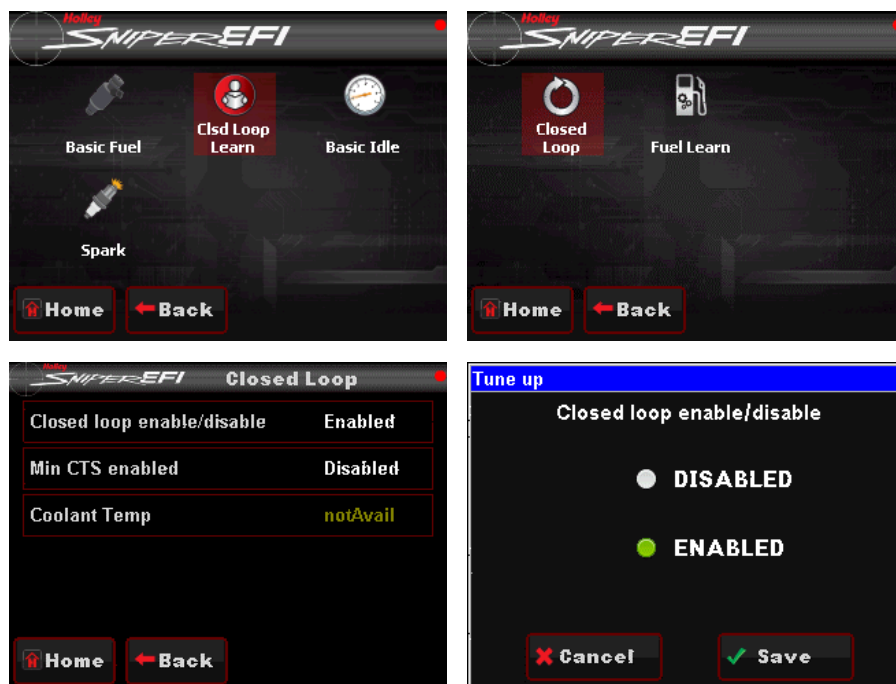

Learn Enable/Disable

The LEARN Enable / Disable menu turns the Self Tuning “On” and “Off”. If enabled, self-tuning is performed. Learning should be enabled when an engine is first run with the Sniper EFI and the tuning process is occurring. After the vehicle is driven under various operating conditions, and is running well, it is advised to limit the amount of learning that can occur in the Advanced Learn menu. As closed loop trends towards 0% (-5% through 5%), the learning is complete in that particular area of the fuel map.

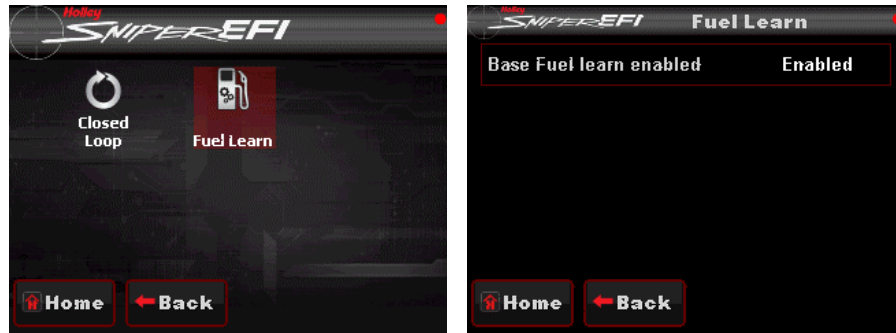

Basic Idle

Selecting BASIC IDLE allows you to change the Target Hot Engine Idle Speed. This should be adjusted to your desired idle RPM. Values between 650-800 rpm are typical. Larger camshafts or aftermarket torque converters may require a slightly higher value to maintain proper idle quality while in gear.

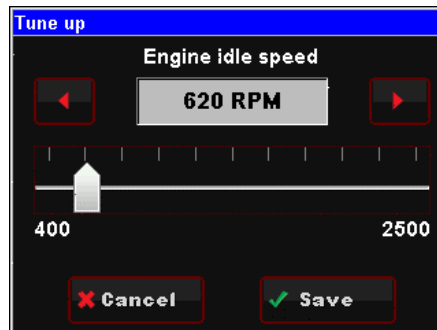
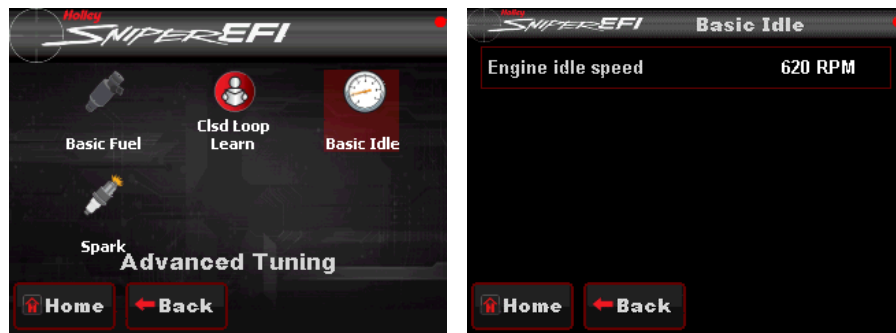

Spark

All Holley base tunes contain timing curves that will allow the engine to run, however the ignition timing at idle, cruise, and wide open throttle can be adjusted independently from each other to compensate for different engine combinations, elevation and climate extremes.

The following are typical values for each:

-Idle Timing – 18-34 degrees is typically used at idle. The larger the camshaft, the more timing is usually used.

-Cruise Timing – 32-48 degrees is typically used when cruising for optimal fuel economy.

-Wide Open Throttle Timing (WOT) –. Older V8 engines are usually between 32-38 degrees.

NOTE: Too much timing can cause pre-ignition that can damage an engine. Be cautious when tuning.

NOTE: The actual timing between IDLE, CRUISE, and WOT is blended together automatically. Consequently, the timing you see on the MONITOR screen, may not be exactly what you set for these settings. Changing these settings raises or lowers the “curve” of that specific area.

NOTE: The ignition timing map built using the handheld is very basic and each engine will perform much more optimally with an ignition timing curve built for the specific engine combination. Using the Sniper EFI PC Based software allows for a user to build a custom ignition timing curve.

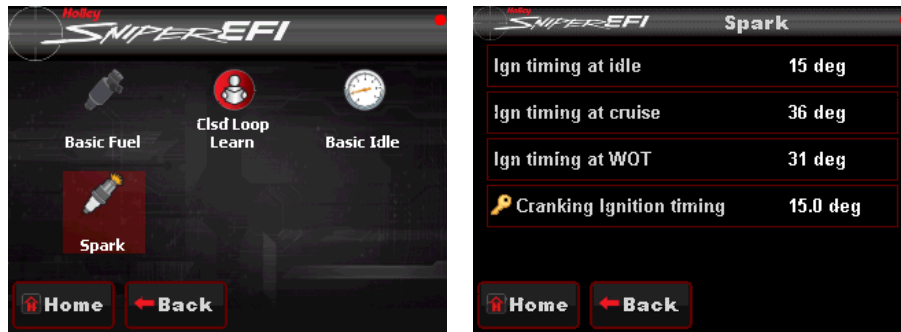

SYSTEM TUNING

From the HOME MENU, select TUNING, and SYSTEM. There are four areas you can modify; Outputs, Engine Setup, Sniper Setup, Ignition Setup, and Static Timing.

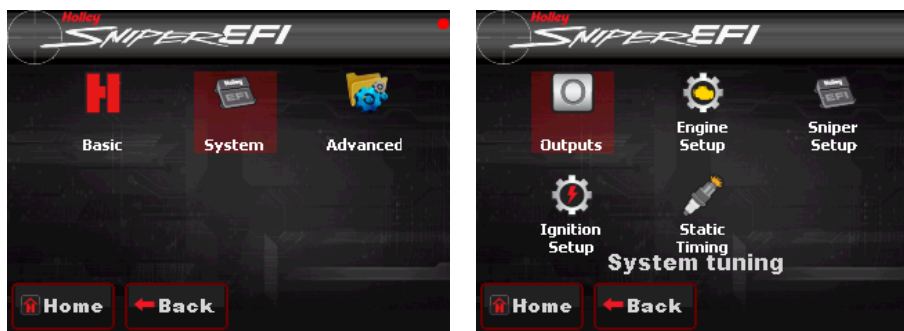

Outputs

The OUTPUT screen allows for the Fan #1 and Fan #2 ON and OFF temperatures to be adjusted. The ON temp needs to always be a higher value than the OFF temp. Use a difference of at least 5 degrees so they aren't cycling excessively. In Sniper EFI these are ground outputs that should be wired to trigger the fan relays. NEVER wire them directly to the fans.

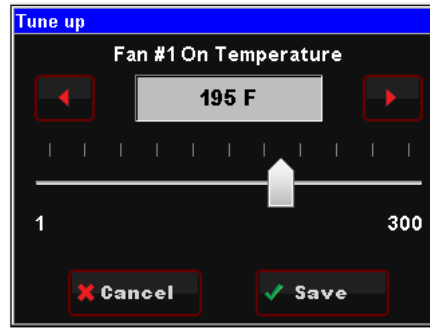
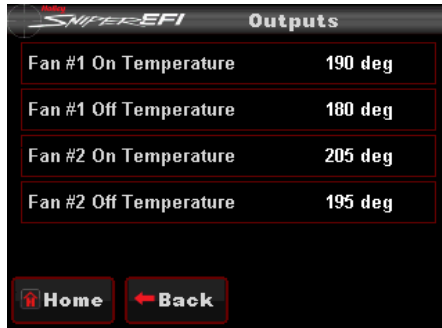

Engine Setup

These parameters should be all properly pre- set when you went through the Wizard Process. They can be modified here, and if the Key Icon is next to the Parameter, the change will not take place until the ignition is cycled.

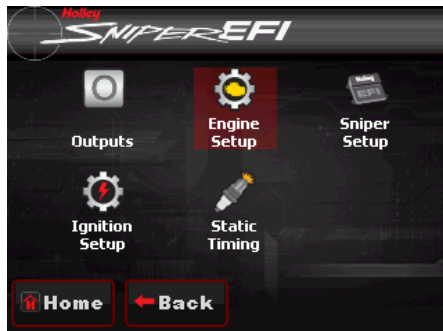

Number of Cylinders: Adjust the number of cylinders of the engine

Engine Displacement: Enter the actual size of the engine

CAM Type: Different cam selections change certain parameters within the calibration

- Stock/Mild = This selection will work well on most applications equipped with stock or “street performance” camshafts. Choose Stock/Mild If you are unsure of your camshaft specs
- Street/Strip = Select this if your engine has between 8” and 13” of manifold vacuum
- Race = Select this if your engine has less than 7” of manifold vacuum. Race oriented camshafts may require laptop tuning for optimal idle stability

KPA to Engine Vacuum at Sea Level	
KPA	Manifold Vacuum (inHg)
100	0.0
90	3.0
80	5.9
70	8.9
60	11.8
50	14.8
40	17.7
30	20.7
20	23.6

Sniper Setup

These parameters should be all properly pre- set when you went through the Wizard Process.



System Type: Change the calibration for different part numbers within the Sniper EFI Family

Fuel Injector Flow: Verify the Fuel Injector Flow matches what the Sniper EFI has installed, 100.0 lb/hr

Actual System Fuel Pressure: Adjust the actual base system fuel pressure that the Sniper EFI is subject to. If using the Sniper EFI internal Regulator the pressure should be set to 60.0 PSI.

Ignition Setup

These parameters should be all properly pre- set when you went through the Wizard Process. They can be modified here. **Note:** If the Key Icon is next to the Parameter, the change will not take place until the ignition is cycled.

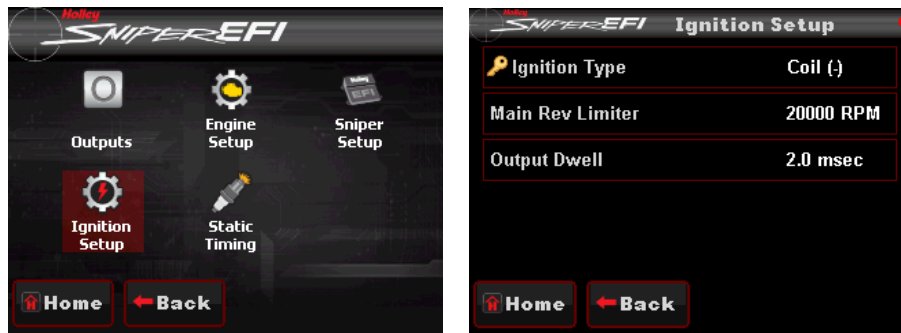

Ignition Type: Change the calibration for different ignition setups

Reference Angle (Timing Control Configurations Only): This is the value in crank degrees of the distributor's crank pulse. These values are preset in the base calibrations and should not need to be adjusted.

Main Rev Limiter: The RPM threshold where the Injectors will turn off

Inductive Delay (Timing Control Configurations Only): Use this value to sync timing at higher RPMs. These values are preset in the base calibrations. Some ignition modules may need this number altered if the commanded timing does not match the commanded timing as engine speed increases. If the timing starts to retard as rpm increases, this number can be increased in order for the timing to match. Recommended increments is in 20 usec until the timing matches the commanded at all RPMs.

Output Dwell: This value changes the points output dwell time. This value is preset in the base calibrations and should not need to be adjusted.

Note: Values above 2.5 can lead to premature coil driver failure.

Static Timing

These parameters should be used when having the Sniper EFI control the ignition timing to sync actual engine timing with commanded timing. Use the "static timing set" function and set the timing to a fixed value such as 15 degrees. Rev the engine up as high as possible (using appropriate caution/safety). Verify that the engine timing matches at all rpms the Static Value setting. If it does not, the inductive delay will need to be changed in the Ignition Setup Screen until the timing of the engine matches the value set in the Static Timing Screen.

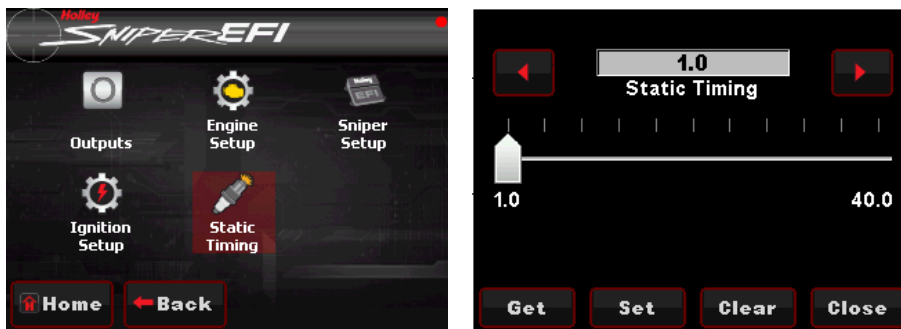

Get Icon: If static timing has been set and user has navigated to another screen in the handheld, press the "Get" icon to view what the static timing has been set to.

Set Icon: Enter the value that you would like the EFI to command

Clear Icon: Will turn the static timing off and the Sniper EFI will reference the Base Timing Table and all enabled modifiers for the timing value. Turning the ignition off will also turn the static timing off.

Close Icon: Will allow you to navigate back through to the Ignition Setup Menu.

ADVANCED TUNING

From the HOME MENU, select TUNING, and ADVANCED. There are five areas you can modify; ADV FUEL, CLOSED LOOP, ADV. LEARN, ADV. IDLE and LAUNCH. These are reviewed below.

The Advanced Tuning areas typically won't ever be needed to be changed. However, after getting used to the Sniper EFI system, there may be some fine tuning of various parameters that you'd like to perform.



Advanced Fuel

Coolant Enrichment: Coolant enrichment is similar to the choke on a carburetor. Adjustments are made as a percentage of the base map from 100% to 150%. 100% would mean no additional fuel is being added by the Coolant Enrichment, 110% would mean that an additional 10% of fuel is being added to the base fuel map which will decay back to 100% in relation to actual engine coolant temperature. The Sniper EFI Learning function will not be active until Coolant Enrichment is at 100%.

Load Based Acceleration Enrichment: This parameter provides another way of adding fuel when the accelerator is depressed. It adds fuel depending on how fast the MAP sensor reading changes (detects a change in engine load). There is typically no need to adjust this parameter except possibly under some extreme conditions or vehicles that are heavy or under-powered. Adjustment values are in pounds of fuel per hour (pph) and should initially be adjusted in increments of 5-10 pph.

Cranking Fuel: This dictates how much fuel is injected when the engine is cranking and is dependent on coolant temperature. Changing this value offsets the entire curve at all temperatures. Adjustment values are in pounds of fuel per hour (pph) and should initially be adjusted in increments of 2-4 pph.

Afterstart Fuel: The afterstart parameter is fuel that is added for a short time immediately after an engine starts. This value varies depending on engine temperature. Changing this value offsets the entire curve at all temperatures. Adjustments are made as a percentage of the base map from 75% to 200%, 100% would mean no additional fuel is being added, 110% would mean that an additional 10% of fuel is being added to the base fuel map, and 85% would mean that 15% of fuel is being taken away from the base map. All selections will decay back to 100% over a predetermined amount of time.

AE TPS vs CTS: Modifies the AE vs TPS Rate of Change Graph based on engine coolant temperature. 100% does not change the base table. Numbers above 100% will add that percentage (for example, 150% will add 50% to the base table). Numbers below 100% will decrease the percentage of the base table. Values as high as 300% are possible at cold engine temps. Values will approach 100% and possibly less as an engine reaches operating temperature.

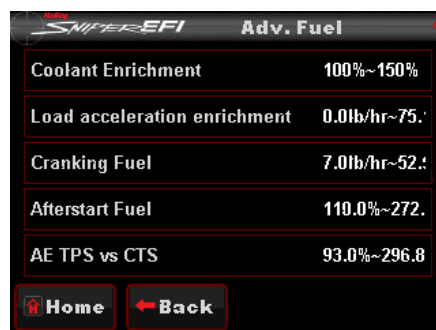

Closed Loop

CLOSED LOOP OPERATION relies on WBO2 sensor readings. The Sniper EFI system uses these readings to analyze 'real time' running conditions. The data obtained by the ECU is then used trim fuel flow to achieve the targeted air fuel ratio (AFR). Choosing CLOSED LOOP from the ADVANCED TUNING menu will allow you to modify 3 areas of the CLOSED LOOP operation.

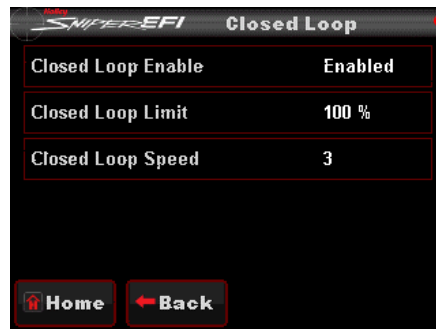

Closed Loop Enable/Disable: This menu enables or disables closed loop operation. There is typically no reason to turn off closed loop operation unless you suspect an oxygen sensor problem and want to disable the sensor. **Note:** Self-Tuning requires closed loop operation to function.

Closed Loop Limit: The maximum percentage the ECU is allowed to deviate (+/-) from the base fuel calibration in order to maintain the commanded target air fuel ratio. This is set to 100% by default and under most circumstances should not need to be changed.

Closed Loop Speed: This is the "speed" (gain) at which closed loop operation occurs. This can be set to five levels, 1, 2, 3, 4, or 5. 3 is the base setting and should be good for most applications. 4 or 5 is typically not used as the closed loop speed may be too excessive for certain applications. If the oxygen sensor is installed far back in the exhaust (more than 1 foot back from the collector in long tube headers), a value of 1 or 2 may be needed.

Closed Loop 2

Choosing CLOSED LOOP from the ADVANCED TUNING menu will allow you to modify 2 more areas of the CLOSED LOOP operation.

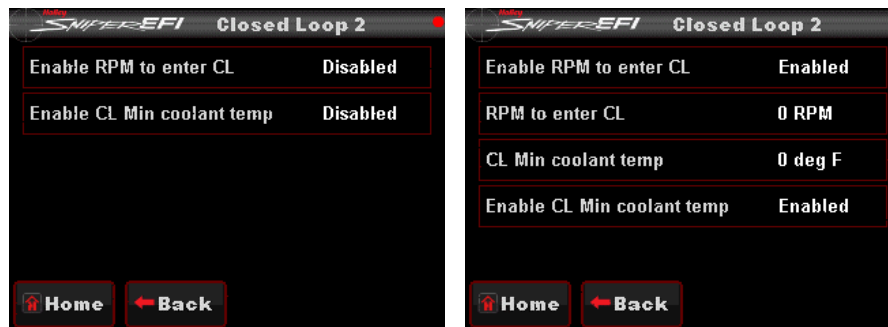

Enable RPM to enter CL: This setting is disabled by default. If an extremely large camshaft is used (specs only typically found on race camshafts), the overlap sometimes causes a "false lean" reading at low RPM. In these cases, it may be required to enable this function and put in a value of above idle RPM so the system operates open loop below this RPM setting.

Enable CL MIN coolant temp: This setting is disabled by default. If enabled the engine will run in open loop until the temperature value entered is reached.

Advanced Learn

Choosing ADVANCED LEARN will allow you to adjust the learning functions within the Sniper EFI.

Learn comp limits: This value is set to 100% by default, and should remain there until ample driving time and tuning has occurred. The LEARN COMPENSATION LIMIT is a parameter that ECU is allowed to work within when making changes to the fuel map based upon CLOSED LOOP operation. Unlike the CLOSED LOOP LIMIT which is a set parameter for commanded changes to actual fuel flow based upon the O2 sensor reading, LEARN COMPENSATION LIMITS are the percentage of change that is allowed to actually be saved as a modifier to the fuel map.

Transfer Table: When run is pressed, it will transfer the Learn Modifier table to the Base Fuel Table and Zero out the Learn Values. When “Run” is pressed the Sniper EFI will prompt if you would like to smooth the fuel table with the learned values. It is recommended you allow the Sniper EFI to perform the smoothing.

Advanced Idle

The ADVANCED IDLE parameters adjust specific characteristics of how the idle air control motor functions on engine decel and startup. Selecting ADVANCED IDLE brings up the following menu:



IAC Rampdown

The Idle Air Control (IAC) motor is a stepper motor located in the throttle body that controls the idle speed of the engine by metering air. It also operates during engine cranking and when the engine returns back to idle. The following settings can adjust how that functions. The IAC moves from a position of 0% (fully closed, no air added) to 100% (fully open, maximum air flow).

NOTE: Contact Holley Tech Support if you have any questions regarding IAC settings.

Selecting IAC RAMPDOWN brings up the following menu with four choices, IAC HOLD POSITION, IAC RAMP DECAY, IAC RAMP START, and IAC KICK. These are reviewed below:

- **IAC Hold Position:** This is the position the IAC motor will “hold” or “freeze” at when the TPS moves above idle (when TPS becomes greater than 0%). If it is too high, the engine RPM will “hang” and not return to idle.
- **IAC Ramp Decay:** This is the time (in seconds) it takes for the IAC to decay from the “IAC Hold Position” back to a “0%” position. It is a linear decay.
- **IAC Ramp Start (RPM above idle):** This value is the RPM added to the target idle speed that the IAC will automatically start to ramp back down to idle. If this is too low, the engine RPM will “hang” and not return to idle.
- **AC Kick:** The AC Kick provides a temporary increase in IAC position to keep engine the RPM from dropping. Typically this is used in conjunction with an A/C system to keep the engine speed from ‘dipping’ as the compressor cycles on and off.



IAC Speed

This menu is used to select the type of IAC motor application that is being used. This selection drives the background parameters that control the IAC motor. These parameters have been fine tuned for each of these applications, eliminating the need for the user to perform further modifications

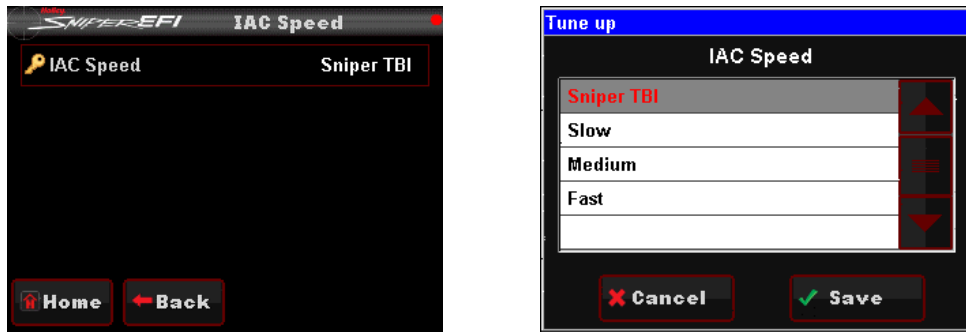

IAC Startup

These parameters control the position of the IAC when the engine is cranking and immediately after it starts.

Selecting IAC STARTUP brings up the following menu with three choices, IAC PARKED POSITION (CRANKING), IAC STARTUP HOLD TIME, and IAC STARTUP DECAY TIME.

- **IAC Parked Position (Cranking):** This is the position the IAC motor will be at during cranking and immediately after the engine starts. If it is too high, the engine will be at too high of an RPM once it starts. Too low and poor starting will result. Note that this is a temperature based table. The percentage value changed in the handheld offsets this entire curve.
- **IAC Startup Hold Time:** This is the amount of time that the IAC will remain at the "IAC Parked Position".
- **IAC Startup Decay Time:** This is the amount of time for the IAC to decay from the "IAC Parked Position" back to its "Target Idle" position. It is a linear decay.



Idle Spark

Idle spark is a feature active only when the ECU is controlling timing. When enabled, the ECU modifies commanded timing at idle to help maintain the target idle speed.

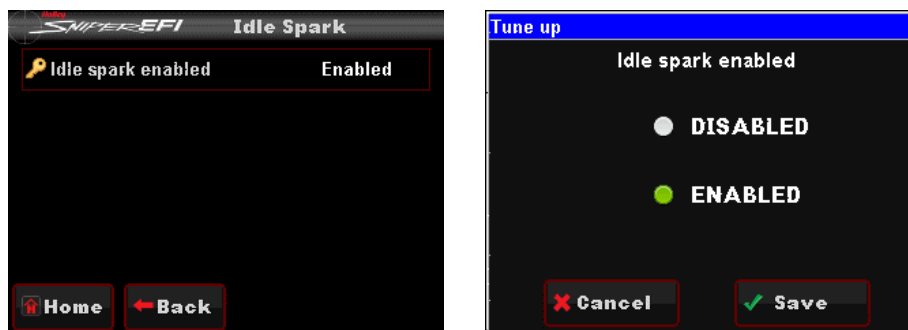

NOTE: This feature should be disabled when checking base timing with a timing light and not using the Static Timing option. If not disabled rev the engine to approximately 2000 RPM when syncing timing.

Idle Speed

Idle speed will allow you to change the target idle speed for different coolant temperatures.

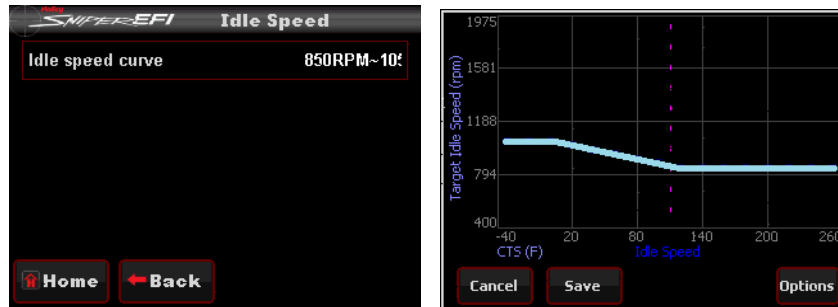

Launch

Sniper EFI has a secondary rev limiter and the ability to retard the ignition timing after a trigger point. These functions are typically used for drag racing.

2 Step

This allows for a secondary rev limiter when the Sniper EFI sees a ground on one of the inputs. This must be enabled and the correct input must be selected that will be used to activate the secondary rev limiter.

Rev Limiter #1 Enable: Enables or Disables the 2 Step Function

Rev Limiter #1 RPM: Desired value for RPM while 2 Step function is active

Rev Limiter #1 Input: Choose which input will be used to activate the 2 Step Function



Launch Retard

The Sniper EFI launch retard will retard the engine ignition timing when this is enabled.

Launch Retard Enable: Enables or Disables the Launch Retard Function

Launch Retard: Table that can be modified by user. To change the axis scale, the Sniper EFI PC Software must be used.

Type: The launch retard can be configured as RPM or TIME based

Launch Retard Activation: The launch retard will be active when the specified input see signal, or when the specified input loses signal

Launch Retard Input: Choose which input will be used to activate the Launch Retard

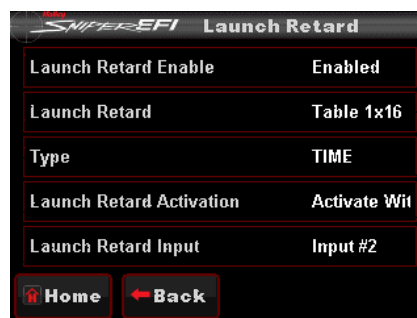

SNIPER EFI MONITOR

Sniper EFI allows the user to monitor different channels using the 3.5" TSLCD. These values can be viewed by pressing Monitor from the main Sniper EFI menu. The channels can be configured for the specific application the Sniper EFI is being used with and personal preference. Channel scaling and custom dashes can be configured on the 3.5" TSLCD.

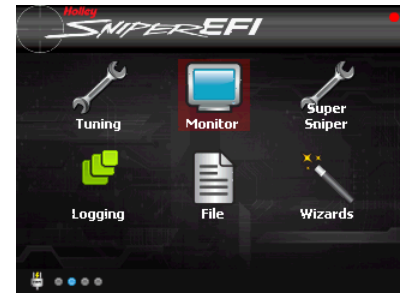

Monitors

Sniper EFI Monitors show live data in a list format. If you press "All on Gauges" it will display the same values as a gauge.



Below are an example of the sensors screen and the Sensors displayed a gauge

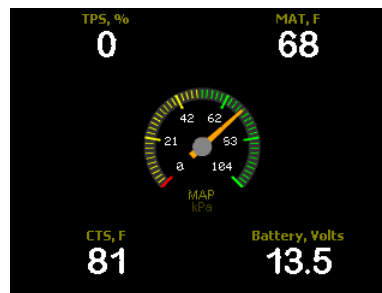
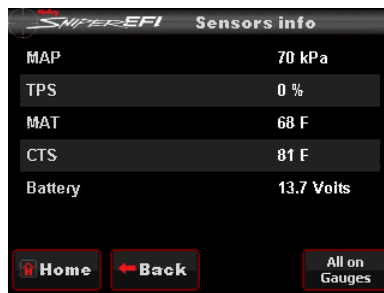

Multi-Gauge

Sniper EFI Multi-Gauge shows live data in a gauge format.

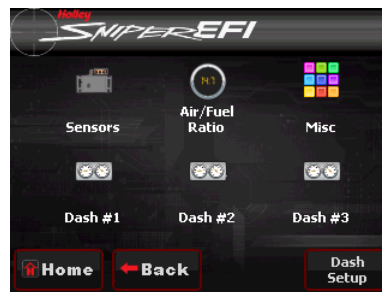

Below are an example of the Sensors Multi-Gauge and the Air/Fuel Ratio Multi-Gauge

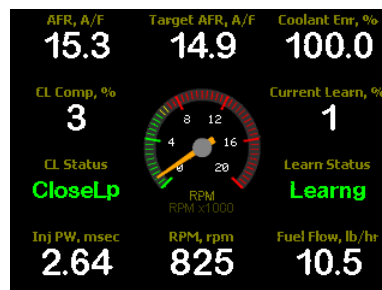
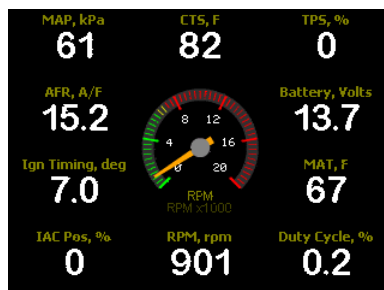

Changing Monitor Channel Scaling

You can change the scale and background warning activation thresholds on the data monitor channels

1. Press the "Monitor" icon from the main menu



2. Press the "Channel Scaling" icon



3. Choose what parameter you would like to modify, I.E. "Air/Fuel Ratio", Press OK
4. The 6 Rectangles can be modified to display the desired values, once those values have been changed, Press Save, and then Cancel to get back to the "Monitor" Screen
 - i. Display Min: Lowest Value Analog Gauge will display
 - ii. Display Max: Highest Value Analog Gauge will display
 - iii. Caution Min: Where Gauge Warning will become Red on Low Side
 - iv. Caution Max: Where Gauge Warning will become Red on High Side
 - v. Normal Min: Where Gauge Warning will become Yellow on Low Side
 - vi. Normal Max: Where Gauge Warning will become Yellow on High Side

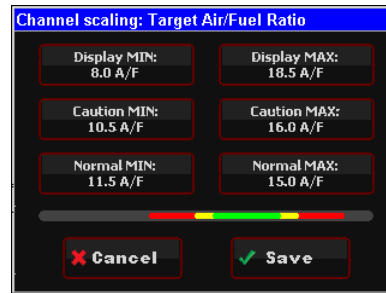

Example: Air/Fuel Ratio:

Large Round Sweep from 8.0-18.5AFR

Red Background when Leaner than 16.0 and Richer than 10.5

Yellow Background when between 15.0-16.0 AFR and 10.5-11.5 AFR

Green Background From 11.6-14.9

- i. Display Min: 8.0 A/F
- ii. Display Max: 18.5 A/F
- iii. Caution Min: 10.5 A/F
- iv. Caution Max: 16.0 A/F
- v. Normal Min: 11.5 A/F
- vi. Normal Max: 15.0 A/F

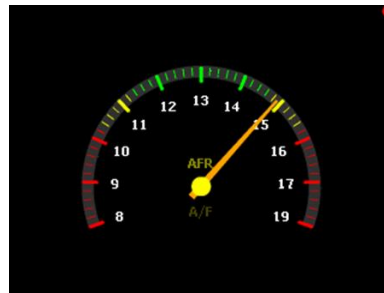

Custom Configuring Dash 1 Dash 2 or Dash 3

Dash 1, Dash 2 & Dash 3 are user customizable dashes using the predetermined channels in the Sniper EFI. The customer can choose how to setup these Monitor Screens to their own personal preference.

1. Press the "Monitor" icon from the Main Menu



2. Press the “Multi-Gauge” icon from the Monitor Menu



3. Press the “Dash Setup” icon from the Multi-Gauge Menu



4. Choose which dash you would like to customize, Dash 1, Dash 2 or Dash 3
5. Press the “Change Layout” icon to change the number of channels that can be displayed

6. Press the “Change channels and gauges” icon to change which channels and how they are displayed within the layout chosen in step 5.

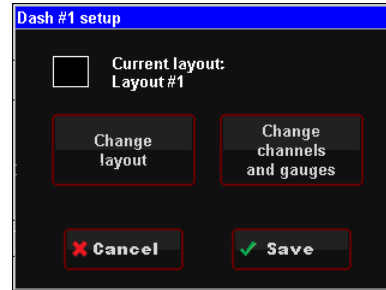

7. After you are satisfied with the customization selections press save and look at the dash you have custom created. Here are some examples of custom dash configurations.

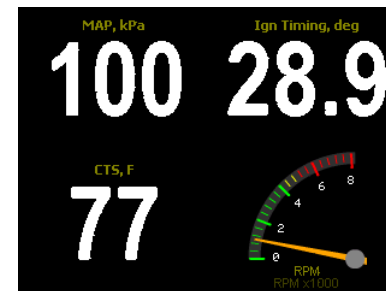
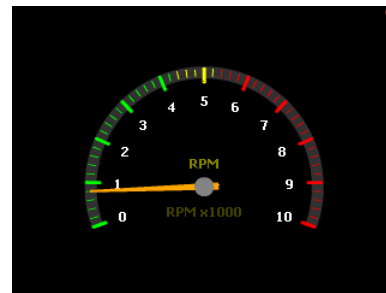

NITROUS TUNING ON HANDHELD

This is not supported with Standard 2300 Sniper EFI. Nitrous Control is supported with 550-852, 550-853, 550-854, but must be configured using the Sniper EFI Software. Please read the Sniper EFI software instructions to properly setup the Boost Controller in the software and determine what certain parameters do.

BOOST CONTROL ON HANDHELD

This is not supported with 2300 Sniper EFI. Boost Control is supported with 550-852, 550-853, 550-854, but must be configured using the Sniper EFI Software. Please read the Sniper EFI software instructions to properly setup the Boost Controller in the software and determine what certain parameters do.

ADVANCED TABLES ON HANDHELD

The configurations in the advanced tables must be setup using the Sniper EFI Software. Once those are configured limited number of parameters may be adjusted in the handheld. Please read the Sniper EFI software instructions to properly setup the Advanced Tables in the software and determine what certain parameters do.

TUNING DEFINITIONS

Basic : Basic Fuel

<i>Target AFR</i>	Target air fuel ratio at idle	Typically between 13.5 and 15.0. Engines with larger cams may need a richer setting for smoothest idle.
	Target air fuel ratio at cruise	Typically between 13.5 and 15.5. Engines with larger cams may need a richer setting for smoothest operation.
	Target air fuel ratio at WOT	Typically between 12.0 and 12.8. Running richer may reduce power. Running leaner may reduce power or cause potential engine damage
	<i>Note: The Target Air/Fuel setting between IDLE, CRUISE, and WOT is blended together automatically. Consequently, the air/fuel you see on the MONITOR screen, may not be exactly what you set for the settings. Changing these settings raises or lowers the "curve" of that specific area.</i>	
<i>Acceleration Enrichment</i>	Acceleration Enrichment	Changes the "accelerator pump" function of the fuel injection. Raising the number increases the amount of fuel added when the pedal is pushed. Lowering the number decreases the amount of fuel added when the pedal is pushed. It is highly recommended NOT to change this until the ECU is allowed to perform self-tuning
<i>Fuel Prime</i>	Fuel prime enable	Fuel prime is an option that is enabled by default in all of the base calibrations. The fuel prime function injects a small shot of fuel into the intake manifold 2.5 seconds after the ignition is turned on (which is also the amount of time it takes the 3.5" touch screen to power up), wetting the intake and allowing the engine to start much quicker. The amount of fuel injected is based on coolant temperature and cranking fuel. This amount of fuel can be increased or decreased by changing the "Percent" value.
	Fuel prime percent	If the engine seems flooded reduce this value, if the engine seems to want more fuel, increase it. Experiment for best results. Typically this value will range from 75-150% with a maximum of 200%.
	Fuel Prime Multiplier	This value will multiply the "Fuel Prime Percent" at CTS values colder than 160°F. It is a linear decay from -40°F to 160°F (i.e. a value of '5' will provide 5 times the prime shot at -40, 2.5 times at 60, and zero change at or above 160).
	<i>Note: Fuel Prime occurs 2.5 seconds after key-on. If you quickly turn the ignition key without waiting for the full 2.5 seconds, the prime will not occur and it may take longer for the engine to start.</i>	

Basic : Closed Loop / Learn

Closed Loop	Closed loop enable/disable	This menu enables or disables closed loop operation. There is typically no reason to turn off closed loop operation unless you suspect an oxygen sensor problem and want to disable the sensor. Note: Self-Tuning requires closed loop operation to function.
	Min CTS enable/disable	Enable or disable the minimum coolant temp for closed loop operation
	Coolant Temp	Once enabled, use this to set the minimum coolant temp for closed loop operation
Fuel Learn	Fuel Learn enable / disable	The LEARN Enable / Disable menu turns the Self Tuning "On" and "Off". If enabled, self-tuning is performed. Learning should be enabled when an engine is first run with the Sniper EFI and the tuning process is occurring. After the vehicle is driven under various operating conditions, and is running well, it is advised to limit the amount of learning that can occur in the Advanced Learn menu.

Basic : Basic Idle

Basic Idle	Hot engine idle speed	This will adjust the target HOT (above 160°F) idle speed
-------------------	-----------------------	--

Basic : Spark

Spark	Ignition timing at idle	18-34 degrees is typically used at idle. The larger the camshaft, the more timing is usually used.
	Ignition timing at cruise	32-44 degrees is typically used when cruising for optimal fuel economy.
	Ignition timing at WOT	Varies by engine, but typically between 28 and 40
	Cranking Ignition timing	This is the actual timing during cranking. It is set to 15 degrees at any RPM below 400 by default.
	Note: Too much timing can cause pre-ignition that can damage an engine. Be cautious when tuning.	
Note: The actual timing between IDLE, CRUISE, and WOT is blended together automatically. Consequently, the timing you see on the MONITOR screen, may not be exactly what you set for these settings. Changing these settings raises or lowers the "curve" of that specific area		

Tuning : System

Outputs	Fan #1 On Temperature	The OUTPUT screen allows for the Fan #1 and Fan #2 ON and OFF temperatures to be adjusted. The ON temp needs to always be a higher value than the OFF temp. Use a difference of at least 5 degrees so they aren't cycling excessively. In Sniper Kits these are ground outputs that should be wired to trigger a fan relay. NEVER wire them directly to the fans! Preset to 190°F
	Fan #1 Off Temperature	Preset to 180°F
	Fan #2 On Temperature	Preset to 205°F
	Fan #2 Off Temperature	Preset to 195°F
	AC Shutdown Max TPS	The AC Disable value is a TPS value above which a ground output is sent out to deactivate the air conditioning compressor at wide open throttle Preset to 65%
Engine Setup	Number of Cylinders	Set the number of cylinders your engine has.
	Engine Displacement	This value should reflect your actual engine size. The base fuel table calculates proper fuel flow based upon this value.
	Cam Type	Display only, does not change anything in the tune
Sniper Setup	System Type	Sniper Part number must match selected parameter
	Fuel injector flow	Sniper injectors flow 100 lb/hr @ 60 psi. This value should not be changed.
	Actual system fuel pressure	The internal Sniper regulator is set at 60 psi. If you are using an external regulator instead of the internal regulator, ensure that this setting matches your external regulator's set point.
	Progressive TBI enable / disable	Not available with 4 injector Sniper kits
	TBI secondary blend	Not available with 4 injector Sniper kits
Ignition Setup	Ignition Type	This shows the RPM input type (Coil (-), CD Box, Magnetic, Dual Sync)
	Reference Angle	Only shown if Magnetic or Dual sync is selected. This is the value in crank degrees of the distributor's crank pulse. These values are preset in the base calibrations and should not need to be adjusted.
	Main Rev Limiter	If Sniper is being used for Timing Control, this is the main over-rev value. This rev limiter is Spark Only
	Inductive Delay	Use this value to sync timing at higher RPMs. These values are preset in the base calibrations. Some ignition modules may need this number altered if the commanded timing does not match the commanded timing as engine speed increases. If the timing starts to retard, this number can be increased in order for the timing to match. If the timing starts to advance, this number can be increased in order for the timing to match.
	Output Dwell	This value changes the points output dwell time. This value is preset in the base calibrations and should not need to be adjusted.
	<i>Note: Values above 2.5 can lead to premature coil driver failure.</i>	

Static Timing	Get	This gets the commanded static timing value that has been set previously, if user navigated away from static timing check screen and the ignition has not been cycled.
	Set	This sets the commanded timing to the chosen value
	Clear	This clears the static timing value
	Close	This closes the Static Timing menu

Advanced : Adv. Fuel

Adv Fuel	Coolant enrichment	Coolant enrichment is similar to the choke on a carburetor. Adjustments are made as a percentage of the base map from 100% to 150%. 100% would mean no additional fuel is being added by the Coolant Enrichment, 110% would mean that an additional 10% of fuel is being added to the base fuel map which will decay back to 100% in relation to actual engine coolant temperature.
	Load acceleration enrichment	This parameter provides another way of adding fuel when the accelerator is depressed. It adds fuel depending on how fast the MAP sensor reading changes (detects a change in engine load). There is typically no need to adjust this parameter except possibly under some extreme conditions of vehicles that are heavy or under-powered. Adjustment values are in pounds of fuel per hour (pph) and should initially be adjusted in increments of 5-10 pph
	Cranking fuel	This dictates how much fuel is injected when the engine is cranking and is dependent on coolant temperature. Changing this value offsets the entire curve at all temperatures. Adjustment values are in pounds of fuel per hour (pph) and should initially be adjusted in increments of 2-4 pph.
	Afterstart fuel	The afterstart parameter is fuel that is added for a short time immediately after an engine starts. This value varies depending on engine temperature. Changing this value offsets the entire curve at all temperatures. Adjustments are made as a percentage of the base map from 75% to 200%, 100% would mean no additional fuel is being added, 110% would mean that an additional 10% of fuel is being added to the base fuel map, and 85% would mean that 15% of fuel is being taken away from the base map. All selections will decay back to 100% over a predetermined amount of time.
	AE TPS vs CTS	This curve adjusts the acceleration enrichment as a function of coolant temperature and TPS rate of change. This should not need to be adjusted.

Advanced : Closed Loop

Closed Loop #1	Closed loop enable / disable	This menu enables or disables closed loop operation. There is typically no reason to turn off closed loop operation unless you suspect an oxygen sensor problem and want to disable the sensor. Note: Self-Tuning requires closed loop operation to function
	Closed loop limit	The maximum percentage the ECU is allowed to deviate (+/-) from the base fuel calibration in order to maintain the commanded target air fuel ratio. This is set to 100% by default and under most circumstances should not need to be changed.
	Closed loop speed	This is the "speed" (gain) at which closed loop operation occurs. This can be set to five levels, 1, 2, 3, 4, or 5. 3 is the base setting and should be good for most applications. 4 or 5 is typically not used as the closed loop speed may be too excessive for certain applications. If the oxygen sensor is installed far back in the exhaust (more than 1 foot back from the collector in long tube headers), a value of 1 or 2 may be needed.
	Open Loop below this	This setting is usually zero. If an extremely large camshaft is used (specs only typically found on race camshafts), the overlap sometimes causes a "false lean" reading at low RPM. In these cases, it may be required to put in a value of 1500-2000 RPM so the system operates open loop below this RPM setting
Closed Loop #2	Enable Open Loop below this	Enable or Disable min RPM for Closed Loop operation
	CL Min Coolant Temp	Sets the minimum Coolant Temp for Closed Loop operation
	Enable CL Min Coolant Temp	Enable or Disable min CTS for Closed Loop operation

Advanced : Adv. Learn

Adv. Learn	Learn compensation limits	This value is set to 100% by default, and should remain there until ample driving time and tuning has occurred. The LEARN COMPENSATION LIMIT is a parameter that ECU is allowed to work within when making changes to the fuel map based upon CLOSED LOOP operation. Unlike the CLOSED LOOP LIMIT which is a set parameter for commanded changes to actual fuel flow based upon the O2 sensor reading, LEARN COMPENSATION LIMITS are the percentage of change that is allowed to actually be saved as a modifier to the fuel map.
	Transfer Learned Data	This will transfer data from the Learn Map to the Base Fuel map.

Advanced : Adv Idle

IAC Rampdown	IAC hold position	This is the position the IAC motor will “hold” or “freeze” at when the TPS moves above idle (when TPS becomes greater than 0%). If it is too high, the engine RPM will “hang” and not return to idle.
	IAC Ramp Decay	This is the time (in seconds) it takes for the IAC to return to the target idle range of movement.
	IAC Ramp Start(RPM above idle)	This value is the RPM added to the target idle speed that the IAC will automatically start to ramp back down to idle. If this is too low, the engine RPM will “hang” and not return to idle.
	IAC Kick	The IAC Kick provides a temporary increase in IAC position to keep engine the RPM from dropping. Typically this is used in conjunction with an A/C system to keep the engine speed from ‘dipping’ as the compressor cycles on and off.
IAC Speed	IAC Speed	This menu is used to select the type of IAC motor application that is being used. This selection drives the background parameters that control the IAC motor. These parameters have been fine tuned for each of these applications, eliminating the need for the user to perform further modifications
IAC Startup	IAC parked position (Cranking)	This is the position the IAC motor will be at during cranking and immediately after the engine starts. If it is too high, the engine will be at too high of an RPM once it starts. Too low and poor starting will result. Note that this is a temperature based table. The percentage value changed in the handheld offsets this entire curve.
	IAC startup hold time	This is the amount of time that the IAC will remain at the “IAC Parked Position”. Lower this if the engine 'hangs' at a higher RPM for too long after startup.
	IAC startup decay time	This is the amount of time for the IAC to decay from the “IAC Parked Position” back to its “Target Idle” position. It is a linear decay.
Idle Speed	Idle Speed Curve	Unlike the Idle speed slider bar found in the Basic Tuning menu, this allows for full customization of target idle speed at all coolant temperatures

Advanced : Launch

2-Step	Rev Limiter #1 Enable	Enable or Disable Rev Limiter #1
	Rev Limiter #1 RPM	RPM set point for Rev Limiter #1
	Rev Limiter #1 Input	Choose the input wire used on the 10-pin harness
Launch Retard	Launch Retard Enable	Enable or Disable the programmable launch retard
	Launch Retard Type	Use this to edit the launch retard curve RPM or Time Based
	Launch Retard Activation	Set to Launch Retard to activate with input or at input release
	Launch Retard Input	Choose the input wire used on the 10-pin harness
	Note: Launch Retard requires Sniper EFI laptop software for initial setup	

ECU Overview

ECU Overview	Current Global Folder/File	Displays the name of the current ECU calibration
	Ignition input type	Displays the current Ignition Type
	Wide band O2 sensor type	Displays the current O2 sensor type
	Throttle body type	Displays the current Sniper Type
	ECU Firmware Version	Displays the current Sniper ECU Firmware version
Global Configs	Up- down- loading of GCFs from and to SD	List view of all saved Sniper calibrations on the SD card. This is where you can save, rename, and upload saved ECU calibrations (i.e. pump gas tune, race gas tune)
ECU HW/FW	ECU HW FW info, FW reflash	This screen displays more detailed Sniper ECU information, and is also where you go to upgrade ECU firmware
Local Setup	Touch Calibrate	The touch screen can be recalibrated by following the on-screen instructions
	Local Info	Displays detailed ECU firmware information
	Local Options	Checkbox to enable the "Restore Last Screen at Startup" option

Super Sniper : Nitrous

Activation	Disable	If using Sniper for Nitrous Control, this will Enable or Disable the Stage
	Min RPM	Minimum RPM required for NOS activation
	Max RPM	Maximum RPM allowed for NOS activation. Any RPM above this will turn off the stage.
	Activation Delay	This will delay the activation by the amount selected. The delay starts from the time the stage is triggered. A value of zero means the nitrous will turn on as soon as all activation conditions are met
	Stage Duration	This will set the duration of the nitrous stage, allowing a stage to be turned off at a precise time for bracket racing, or for another layer of safety. This parameter is enabled by default.
Stage 1 Tuning	Fixed Timing Value	If you are using Sniper for timing control, this is the actual timing value the engine will operate with when the Nitrous is activated
	Timing Retard	1x16 editable timing curve. Only available when not using a fixed timing value. This parameter requires Sniper EFI laptop software to configure.
	Progressive Control	Enable/Disable progressive timing retard curve. This parameter requires Sniper EFI laptop software to configure
	Target AFR	Closed Loop compensation will override the target AFR table and use this value as its new target only when the nitrous is on.

Super Sniper : Boost

Launch	Launch Target	Boost control only available on Super Sniper EFI Models. This Parameter requires software for initial configuration.
	Instantaneous boost pressure safety	Boost control only available on Super Sniper EFI Models. This Parameter requires software for initial configuration.
Safety Setup	Time delay boost pressure safety	Boost control only available on Super Sniper EFI Models. This Parameter requires software for initial configuration.
	Time Delay	Boost control only available on Super Sniper EFI Models. This Parameter requires software for initial configuration.
Boost vs RPM	Boost Curve	Boost control only available on Super Sniper EFI Models. This Parameter requires software for initial configuration.
Boost vs Time	Boost Curve	Boost control only available on Super Sniper EFI Models. This parameter requires software for initial configuration.

Super Sniper : Advanced

1D Tables: Table #1-4	Enable/Disable	These tables require software for initial configuration and are intended for advanced EFI users.
	Table Name (display only)	These tables require software for initial configuration and are intended for advanced EFI users.
	Table Type (display only)	These tables require software for initial configuration and are intended for advanced EFI users.
	Enable Start Delay	These tables require software for initial configuration and are intended for advanced EFI users.
	Time Delay to Start	These tables require software for initial configuration and are intended for advanced EFI users.
	Edit Table	These tables require software for initial configuration and are intended for advanced EFI users.
2D Tables: Table #1-2	Enable/Disable	These tables require software for initial configuration and are intended for advanced EFI users.
	Table Name (display only)	These tables require software for initial configuration and are intended for advanced EFI users.
	Table Type (display only)	These tables require software for initial configuration and are intended for advanced EFI users.
	Enable Start Delay	These tables require software for initial configuration and are intended for advanced EFI users.
	Time Delay to Start	These tables require software for initial configuration and are intended for advanced EFI users.
	Edit Table	These tables require software for initial configuration and are intended for advanced EFI users.

DATALOGGING & FILE TRANSFERS

For video instructions on how to take a data log and view the datalog with the Sniper EFI system reference this helpful video:



<https://www.youtube.com/watch?v=rHjLwJQ45Kw&list=PLNMSNx7tRu2sxs6NmwrT3Gi-oO2x0ea>

Taking a Datalog with the 3.5" TSLCD

1. Press "Logging" from the Main Menu

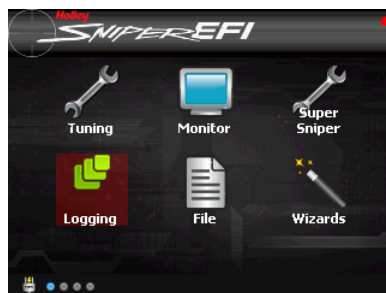

2. To turn on Data Logging press "Start Log" from the Logging Menu

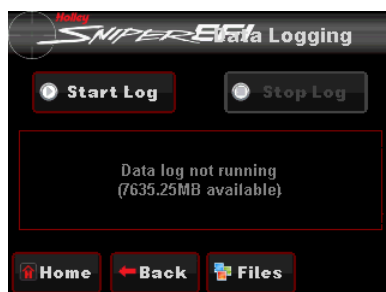

3. To turn off Data Logging press "Stop Log" from the Logging Menu.
 - a. Note: If the ignition is turned off while a data log is running it will not save the datalog. User MUST turn the datalog off before turning the engine off.
 - b. Note: Data log is not able to be viewed from the 3.5" TSLCD. Data log will not show up in the menu if Files Icon is pressed. Datalog will be able to be viewed from the SD card and the Sniper EFI Software on a PC.

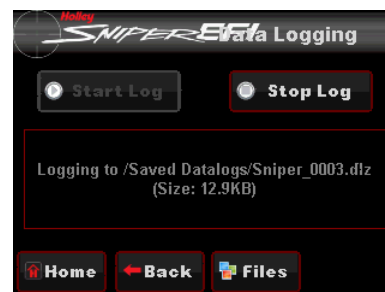

Downloading Global Configuration from Sniper EFI Throttle Body to SD card:

1. Press "File" icon from the Main Menu



2. Press the "Global Configs" Icon



3. Press "Download From ECU"



Press "OK", if you would like to name it with a unique name, user can press "Save GCF as", type the name for the calibration, and press save.

4. SD card now has the Global Configuration that is in the ECU unit, this can be opened up with the Sniper EFI software on a PC.

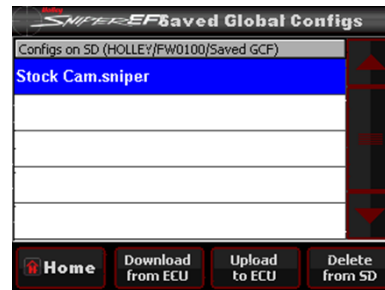

Loading Calibration into Sniper EFI ECU

1. Press "File" icon from the Main Menu



2. Press the "Global Configs" Icon



3. Highlight the Configuration you would like to load into the Sniper EFI (making it highlight in Blue).

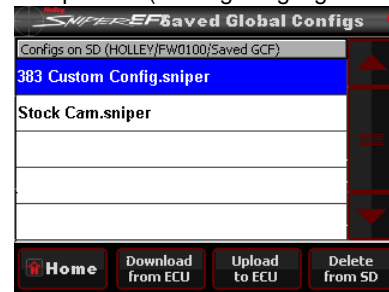

4. Press Upload to ECU and follow the Onscreen Prompts:

- a. Press okay when it asks, "Upload GCF to ECU"
- b. Turn the ignition off for at least 4 seconds when it asks you to. If you press OK, the upload of the calibration will not take place until the ignition is cycled.

5. New Configuration has been uploaded to the Sniper EFI

LAPTOP SUPPORT

At times a computer may be required to view data logs or tweak a tune. This is especially true with anybody wanting to use the Nitrous, Boost, or Advanced Table features in Super Sniper. Purchasing part number 558-443 will allow connecting the Sniper EFI to a Computer directly without using the SD card. Please reference the “Handheld Navigation” section for help retrieving the tune From the Sniper EFI and recording a datalog.

Viewing Global Configuration with Sniper EFI Software without USB Cable:

See section “Download Global Configuration from the Sniper EFI Throttle Body to SD card”

Place SD card in PC that has Sniper EFI Software on it

Put the saved Configuration from SD card (in Saved GCF folder) in the Sniper EFI Config File Folder, this is in your Documents folder if the Sniper Software was installed in the default location

This PC > Documents > Holley > Sniper > Config Files

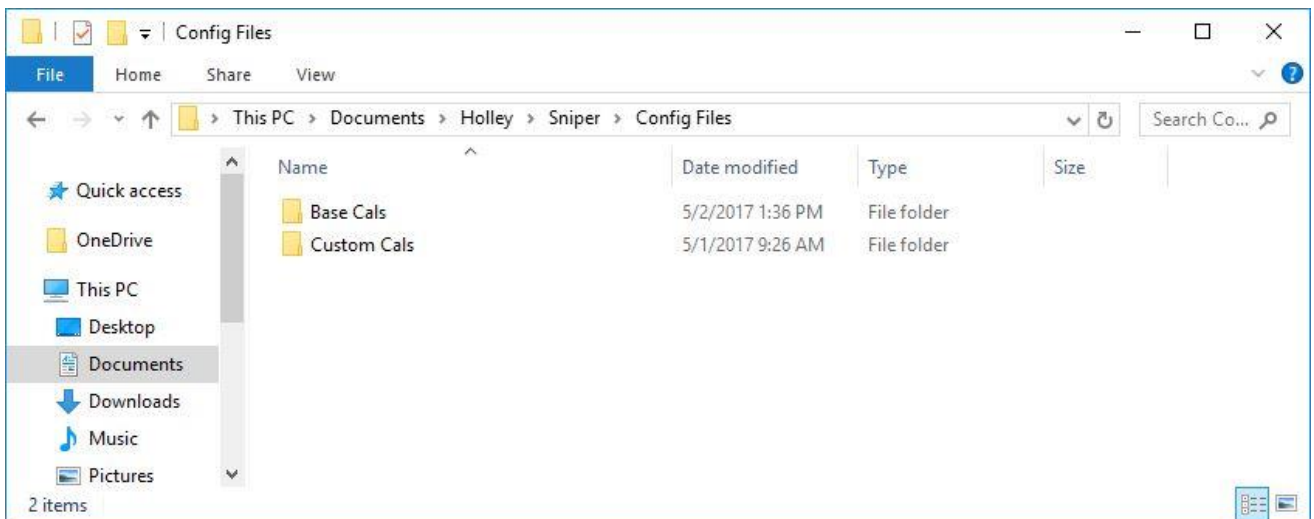

1. Open Sniper EFI Software, and click “Open Config File” icon

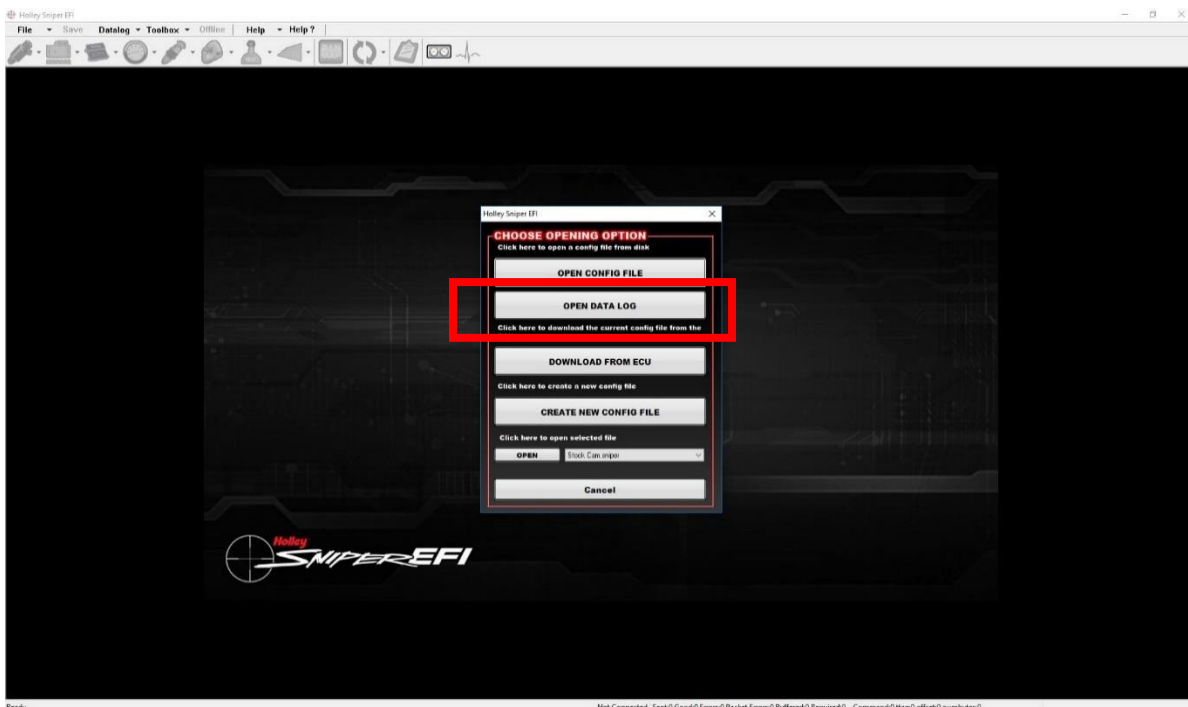

2. Choose the saved Configuration you are wanting to open

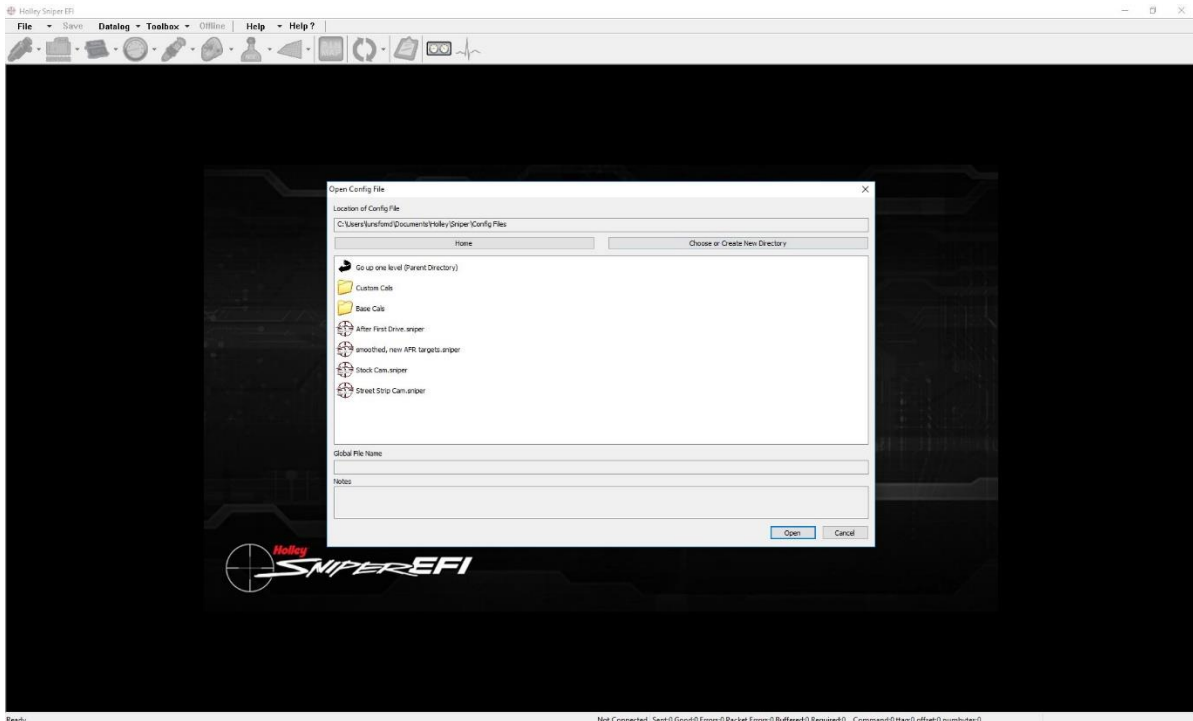

3. Calibration can be viewed and Modified using the Sniper Software. It can be saved directly to the SD card or to the Config Files folder. If saving to the Config Files Folder a copy of the tune will also need to be placed on the SD Card to Transfer it to the Sniper EFI via the Handheld.

Viewing Datalog with Sniper EFI Software:

See section "Creating a Datalog with the Handheld"

Place SD card in PC that has Sniper EFI datalog to view

1. Open Sniper EFI Software, and click "Open Data Log"

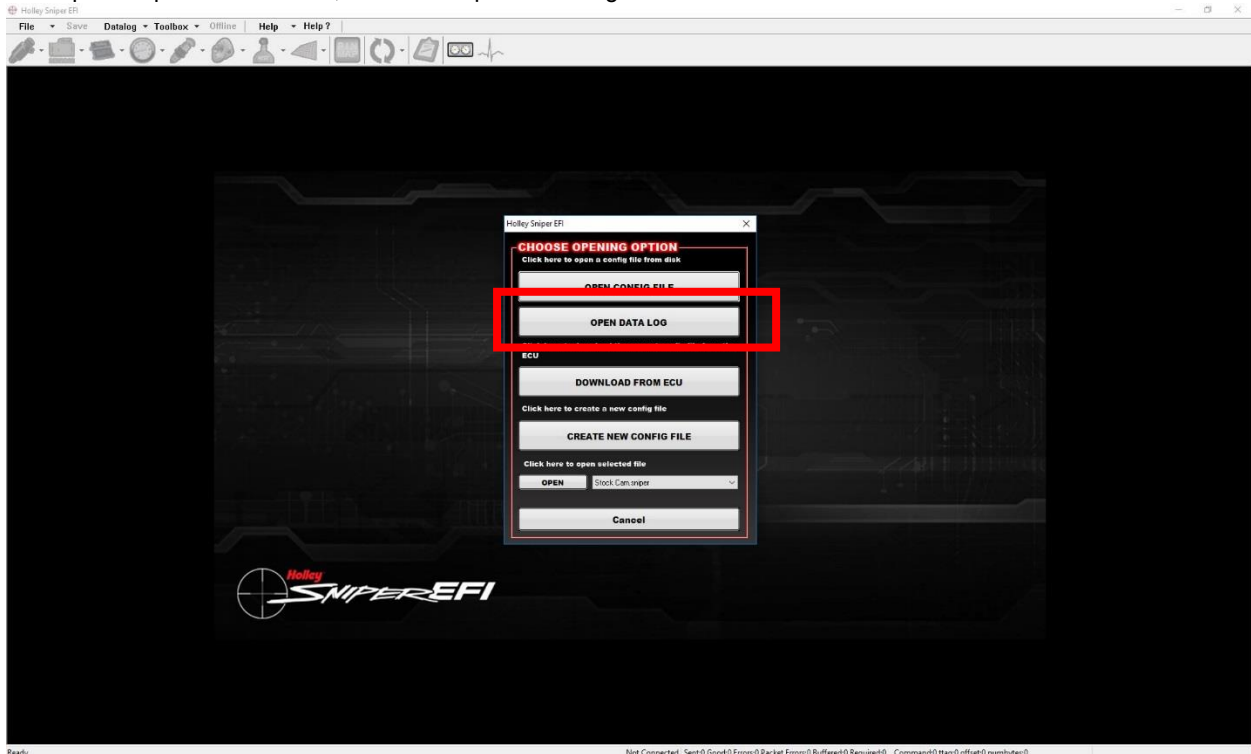

Navigate to the data log on the SD card the file will be in the “Saved Datalogs” folder on the SD card. Next, click the “Open” Button. The data log will open to be viewed.

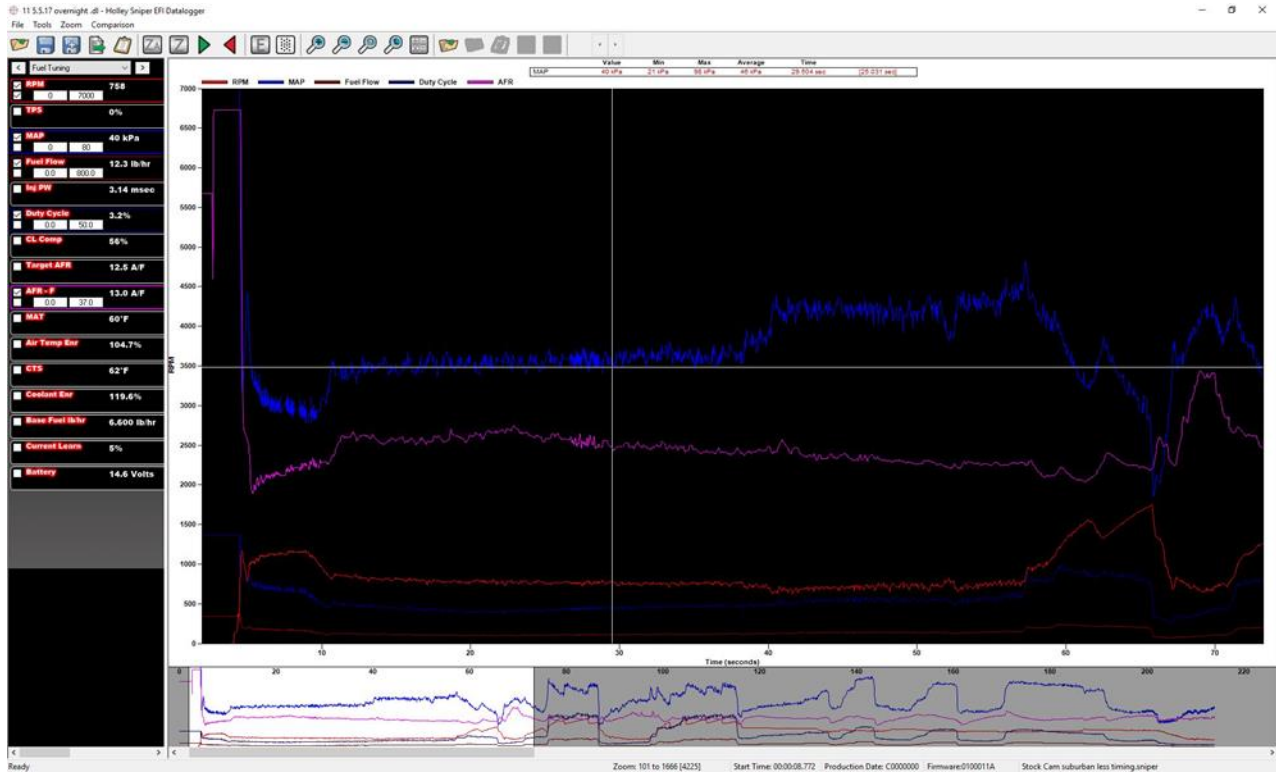

TROUBLESHOOTING

Troubleshooting Guide

Holley has created a troubleshooting flow chart to help customers with issues they may be having. This can be found on www.holley.com. Here is a direct link to the Troubleshooting Guide. <http://documents.holley.com/199r11369.pdf>

Sensor Verification

Verify all sensors are reading properly on the handheld.

- **Engine RPM** – This gauge should show “Stall!”, once you begin cranking the engine it will show actual engine RPM
- **TPS** (Throttle Position Sensor) – Should read 0. Slowly depress the throttle to wide open. It should read between 85 % and 100% at wide open throttle. If it does not, please verify your throttle linkage is allowing full travel of the throttle arm.
- **MAP** (Manifold Air Pressure Sensor) – Should read from 95-102 kPA with the key on engine not running. At high elevations it could read as low as 75 kPA.
- **MAT** (Manifold Air Temperature Sensor) – Should read ambient on a cold engine with the key on and the engine not running.
- **CTS** (Coolant Temperature Sensor) – reads engine temperature. With a cold engine it should read similar to Ambient Temperature. If the indicator reads “LOW Err” double check the connection to the CTS.
- **AFR** (Oxygen Sensor) – Initially should show “Heating” Without the engine running it will read 35.6 AFR once engine starts it should go down and read between 12-14 afr depending on the engine and parameters set. If ignition is turned on and not started, after a period of time, the AFR will start reading “Init...” until the Sniper EFI sees an RPM signal.

Sensor Diagnostics and Statures

Sensor diagnostics are included in the handheld. If one of the main sensors has some type of error, a small, blinking red circle will appear in the upper right of the screen. To navigate to the diagnostics, select MONITOR and DIAGNOSTICS. If there is an issue an error will also be shown on any of the MONITOR or GAUGES screens.

Wideband Oxygen Sensor Status – Shows status of wideband oxygen sensors.

Text	Description
...	Signifies that sensor channel is not enabled.
Init..	First shown for an instant when the system is powered on. Displayed so quickly you will likely not see this.
Heating	Sensor is heating.
Unplgd	Sensor is unplugged.

General Sensor Status – These are shown for the coolant and air temperature, MAP, TPS sensors.

Text	Description
Undefnd	Unlikely failure indicated that a sensor is not properly defined.
LOW Err	A sensor displaying this can be unplugged, have an open or short circuit, or be otherwise damaged.
HI Err	A sensor displaying this can be unplugged, have an open or short circuit, or be otherwise damaged.

RPM (Crank Signal Inputs) Diagnostics – The following are shown for the “RPM” parameter which indicates the status of the crank sensor/engine speed input.

Text	Description
Stall!	No RPM input detected.
Syncng	Signal detected. Position being established.
Nothing	Will show briefly after crank signal and cam/crank positions established. Actual engine RPM will then be indicated.
Error!	Cam/Crank input error detected.

Closed Loop Diagnostics – Shows status of closed loop operation.

Text	Description
OpenLp	System is in open loop operation.
CloseLp	System is in closed loop operation.

Learn Status – Shows status of learn mode.

Text	Description
NoLearn	Learning is not active.
Learnng	Learn is in an active state.

199R11321
Date: 12-4-17