

Holley® HydraMat™

Holley® HydraMat
P/N 12-924

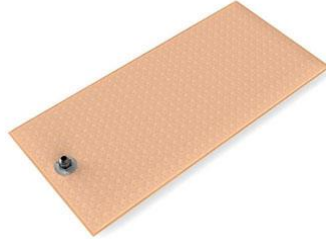

IMPORTANT NOTES:

FUEL COMPATIBILITY:

Works with all gasoline blends (Alcohol, Ethanol, Methanol, and E-85). Not for use with oils, diesel fuels, or any other fluids.

NO PRE-FILTER NEEDED!

All HydraMats are constructed with a 15 micron depth media, so no pre-filtration is required for the fuel pumps. **Use of an additional pre-filter could result in pump failure.**

HYDRAMAT FILTER LIFE EXPECTANCY

The HydraMat filtration performance will provide 5-10 years or more depending on the fuel type, how clean your fuel system is, how much you drive your car, and how aggressively the car is used. Severe duty applications should inspect the filter at regular intervals to ensure the HydraMat is not restricted by debris. The HydraMat is not cleanable.

HYDRAMAT CLEANING

The large majority of the debris is imbedded inside the depth media and cannot be removed. Surface cleaning is not practical or effective and should NOT be done. In extreme conditions (Racing or Off Road) check your HydraMat annually.

HYDRAMAT INSTALLATION:

NOTE: The hose assembly is for reference only. This assembly is representative of a typical hose assembly if being installed in an EFI application. This complete hose assembly can be purchased under Holley P/N 16-200 (includes bulkhead fittings, stat-o-seals, & feed and return hose). If used in a carbureted application, only one feed hose and bulkhead will be required.

1. Lay the HydraMat out and attach an in-tank hose assembly (Figure 1). Tighten the 8AN fitting to 270-350 in./lbs. Tighten the 10AN fitting to 360-430 in./lbs.

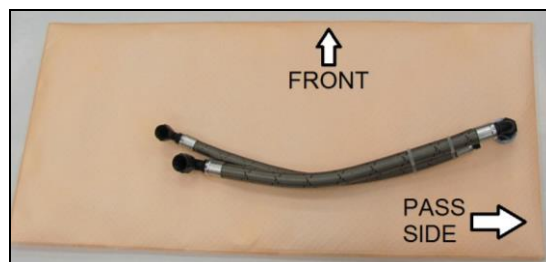

Figure 1

2. Drain fuel cell completely.

3. Remove the fill plate from the fuel cell. Remove foam.
4. Clean the bladder of any sediment or debris.
5. If your fuel cell has the single pickup in the right rear (passenger's side) corner, it is okay to leave this installed as it does not interfere with the reservoir blanket (Figure 2).
6. However, if your fuel cell has a built-in surge tank, it will need to be removed (Figure 3). If it cannot be removed, a new bladder without the surge tank will be required.

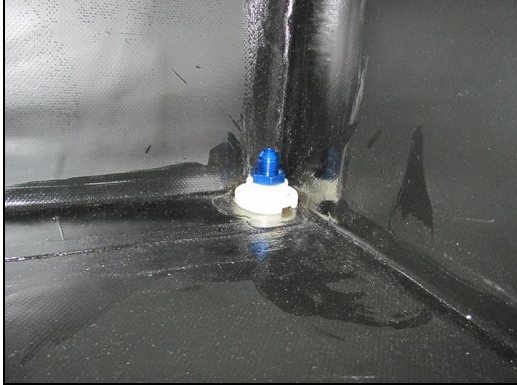

Figure 2



Figure 3

7. Install the HydraMat with the blanket fitting side first toward the right rear (passenger's side). See Figures 4, 5, & 6. Fold and feed into fuel cell toward the right rear (passenger's side) of vehicle. Make sure the HydraMat lays flat on the bottom of the fuel cell (Figure 7).

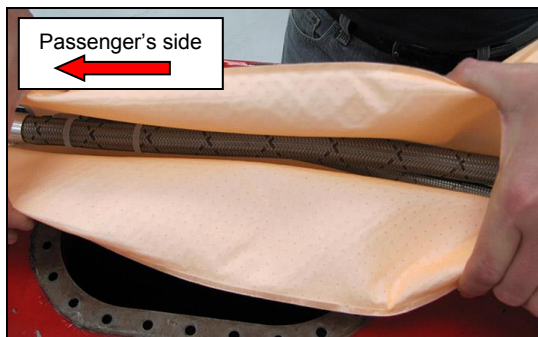

Figure 4

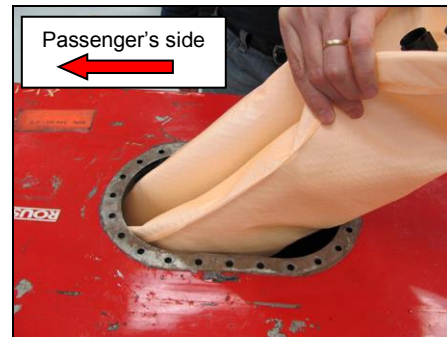

Figure 5

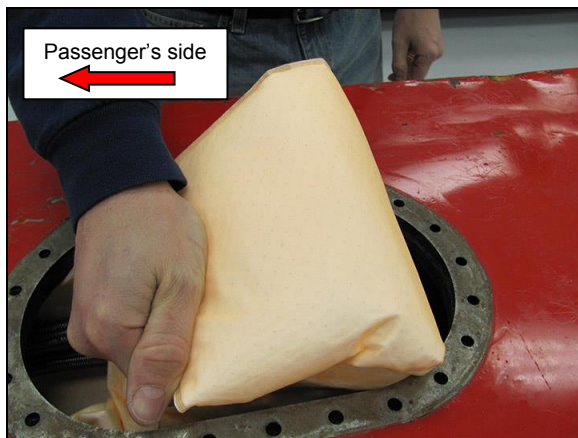

Figure 6

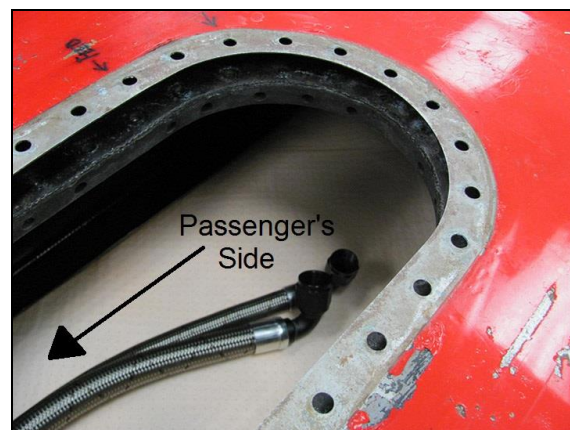

Figure 7

8. Place fill plate on cell and measure where the feed and return hose should be placed. Drill a 57/64" hole for an AT983210ERL feed hose bulkhead and a 49/64" hole for an AT983208ERL return hose bulkhead (bulkheads included in 16-200 hose assembly), or similar (Figure 8 & 9). Make sure there is at least 1.75" center to center on the holes drilled.

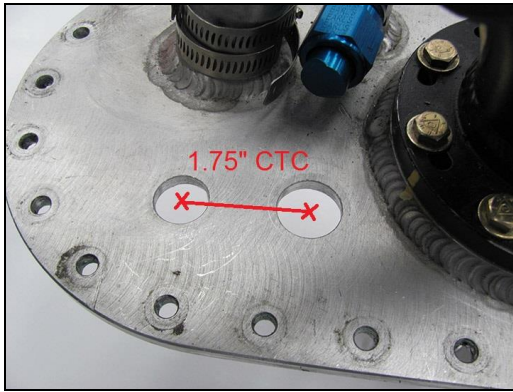

Figure 8

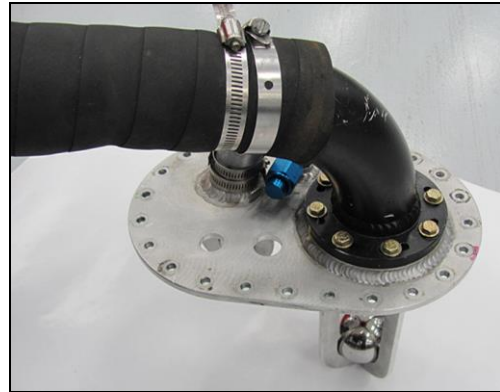

Figure 9

9. Install the bulkhead fittings. Install the stat-o-seals (included in 16-200 hose assembly) or equivalent on each side of the fill plate when installing bulkhead fittings to prevent fuel leaks.
10. Temporarily, attach the feed and return hoses to the bulkhead fittings in the fill plate.
11. Mark and notch the foam to clear the fuel hoses. Disconnect hoses.
12. Reinstall the foam into the cell.
13. Attach the feed and return hoses to the bulkhead fittings in the fill plate. Tighten the 8AN fitting to 270-350 in./lbs. Tighten the 10AN fitting to 360-430 in./lbs. Verify that the HydraMat is flat with no wrinkles. Reinstall the fill plate assembly.



Figure 10

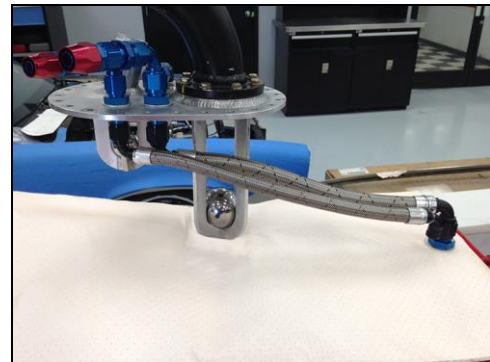

Figure 11

NOTE: Figure 11 shows how the completed fuel reservoir blanket should appear after installation – tank and foam removed for clarity.

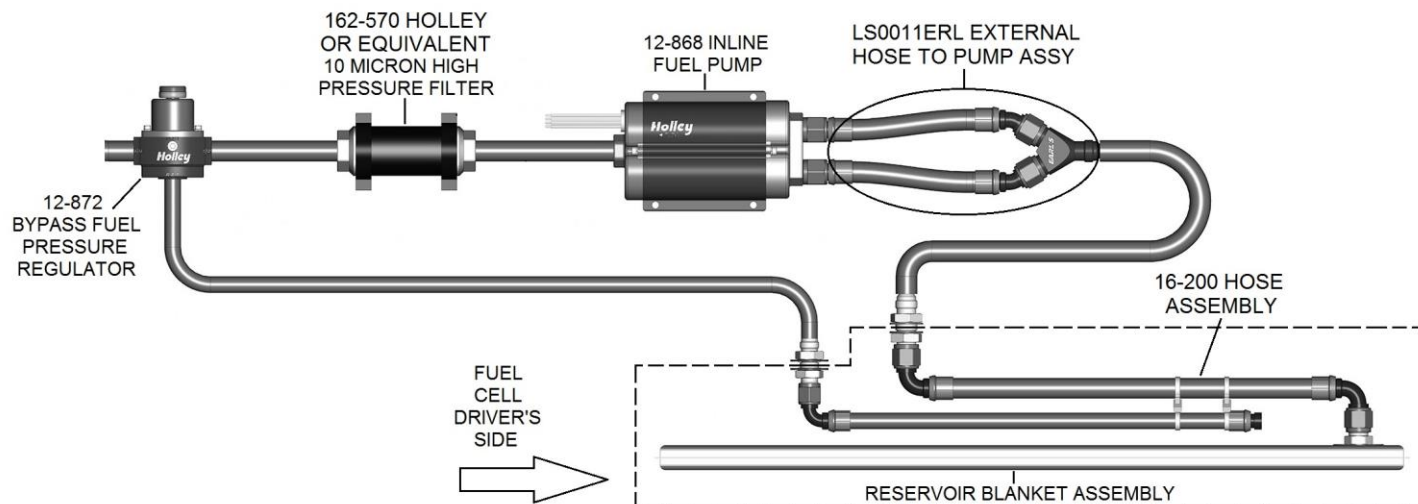

Figure 12

NOTE: Figure 12 shows a typical fuel system installation. The HydraMat can serve as a 15 micron pre-filter. A filter between the HydraMat and inlet side of the fuel pump is not required. It is recommended that the fuel return hose be positioned so that returned fuel exits as close as possible to the pick-up.

Holley® Performance Products
1801 Russellville Road
Bowling Green, KY 42101

1-270-781-9741
1-866-464-6553
www.holley.com

© 2015 Holley Performance Products, Inc. All rights reserved.

199R10807
Revision Date: 8-4-15