



BOOST CONTROL INSTRUCTIONS

TABLE OF CONTENTS

1.0 The Essentials (READ THIS)	2
1.1 Overview.....	2
1.2 Wastegate Types.....	3
1.3 Control Methods	3
1.4 Solenoid and Sensor Selection.....	3
2.0 TURBO & WASTEGATE CONTROL PRIMER (OPTIONAL BACKGROUND MATERIAL)	4
3.0 Main Controller Setup Common to All Configurations	6
3.1 Boost Safety System	8
4.0 Single Port Wastegate Control.....	10
4.1 Application of a single port wastegate with an “Open Loop-Duty Cycle” Control Method	11
4.2 Application of a single port wastegate with a “MAP Pressure” Control Method	12
5.0 Dual Port Wastegate Control	16
5.1 Application of a dual port wastegate with an “Open Loop- Duty Cycle” Control Method.....	17
5.2 Application of a dual port wastegate with a “Dome Pressure Only” Control Method.....	18
5.2.1 Dual Solenoid Setup.....	19
5.2.2 Single Solenoid Setup	20
5.2.3 Source Pressure Setup	21
5.2.4 Dome Pressure Setup	21
5.2.5 Tuning Notes	22
5.2.6 Custom Solenoid Use.....	22
5.3 Application of a dual port wastegate with a “MAP and Dome Pressure” Control Method	25
5.3.1 Base Dome Pressure Table	26
5.3.2 Base Dome Pressure Table PID Control.....	30
6.0 Target Curves	32
6.1 Boost vs. Speed.....	32
6.2 Boost vs. Time.....	33

6.3 Boost vs. Gear	34
6.4 Boost vs. RPM	36
6.5 Boost Manual.....	37
6.6 Boost Builder	38
7.0 Variables for the Boost Control Function.....	39
7.1 Normal Variables	39
7.2 Internal Variables.....	40
8.0 Appendix.....	44
8.1 Layout of a Typical Dual Port Wastegate, Twin Solenoid System	44
8.2 PID Controller Tuning Information	45
8.2.1 Concepts	45
8.2.1 Trying it out.....	46
8.2.3 What to look for	48
8.2.4 An example of the effects of the P Term	51
8.2.5 An example of the effect of the Target Rate Limiter	60
8.3 Solenoid Dead Time	63
8.4 Holley Components	67

1.0 THE ESSENTIALS (READ THIS)

1.1 OVERVIEW

The boost control functionality in the Holley ECU gives you the ability to tweak the boost level of your engine/turbo system electronically within a certain range. It does not have absolute authority over boost: it operates “on top of” a core mechanical control system. All of the system configurations on which the Holley system will work can function without the Holley system being present. The best time to use the Holley boost control functionality is after you have a mechanical system that is proven and stable. Once things are working “on the spring” then it is relatively easy to add on the electronic controls to be able to control your boost to a higher level.

The Holley control system is designed to be somewhat flexible to allow you to pick the kind of strategy that works the best for your application. Different systems need different things. Instead of offering a one-size-fits-all compromise, we give you several options. This means that you have to either know what you are doing or know where to start learning. This is not a self-configuring system. If you know everything about turbos- great. You still need to understand how the Holley control system works in combination with the systems with which you are familiar. If you are starting from zero- that is fine too. Try to gather as much information as you can from different sources, start out slow, and learn as you go. It is doable. This document, unfortunately, is not going to give you everything you need to know about turbochargers and engines. Either way, before you start controlling boost you really need to understand how the system works as a whole and what dictates the boost. If you find yourself shooting in the dark, stop and think.

If you already have a working system and you want to figure out how to make the Holley system work with it, you can skip to the section that is appropriate for your hardware.

If you do not have a working system or you are looking for guidance to build a system from the ground up, it would be good to read the information for the different types of systems to understand what would be best for you. Decide what you want, build everything up, verify that it works without using Holley boost control, and then add on the Holley boost control system.

1.2 WASTEGATE TYPES

Practically speaking, there are a number of major forks in the road in regard to system configuration and setup. The most significant fork in the road is the wastegate type- single port wastegate or dual port wastegate. If you want the most flexibility, use an external dual port because they can also be plumbed as if they are a single port wastegate if so desired. There are also some dual port “can” style actuators that can be used with internal wastegates on some turbochargers.

Single port wastegates are pneumatically the simplest, use one solenoid, do not need extra pressure sensors, and are often integral to the turbine housing. Unfortunately tuning is usually more difficult because of the non-linearity between duty cycle and boost. They usually have reduced control authority compared to a dual port wastegate.

Dual port wastegates are easier to tune because of reasonable linearity between control pressure and boost pressure, have better control authority than the single port style (especially if used with an external pressure source), have more options for the control method, and have more options in the mechanical control components (springs, shims, adjustments, etc). Unfortunately they usually cost more, they are obviously more difficult to plumb than an internal single port wastegate, and they need another pressure sensor (and ECU input).

1.3 CONTROL METHODS

After you know what kind of wastegate you are going to use you have to figure out what you are actually going to control.

For a single port wastegate you have two options- running open loop (using no feedback in the control) or controlling manifold boost pressure. The latter is more appropriate for the vast majority of applications.

For a dual port wastegate you have three options- running open loop (using no feedback in the control), just controlling the dome pressure, or controlling the manifold boost pressure in conjunction with the dome pressure. We recommend starting out doing dome pressure control. You only run completely open loop if you must, and the complexity of simultaneous manifold pressure and dome pressure control is best done after successful application of dome pressure control by itself.

1.4 SOLENOID AND SENSOR SELECTION

After you figure out what you are going to control you have to figure out what solenoids you are going to use to control it and what sensors you might need. For most people running single port wastegates we recommend using the single Holley solenoid 3-port setup, which does not require an extra pressure sensor. For most people running dual port wastegates we recommend using the dual Holley solenoid setup with a sensor dedicated to measuring dome pressure. We also recommend using PWM- outputs to drive the solenoids. If you'd rather use a PWM+ output, use the ones on the J2B connector. The other PWM+ outputs (the only ones on an HP) have a different drive type that extends the solenoid deactivation time. You can use just about any pressure sensor that can be configured in the IO function as long as it has the appropriate range. These are blanket recommendations and there are legitimate reasons to do otherwise, but make sure you read through the appropriate sections later in this document to understand why you would need to deviate from this advice.

This is a plug for our Holley solenoids. We made the system flexible enough to support a wide variety of solenoids and topologies, but the golden rule is this: if you do not want to dig into the nuts and bolts of how the system works and assume the risk of getting it wrong- just buy our solenoids. We do not manufacture them, they are built to our specifications by MAC. Not all solenoids are created equal. No matter what the internet says, solenoids that look identical can have drastically different dynamic performance because of the build options that are available. Think about how many fuel injectors look exactly the same but have wildly different response characteristics. There is nothing magical about the solenoids we use, but we have done the work for you to characterize the solenoids' dynamic response and build in the appropriate compensations in the software. We also include hardware and wiring components in our solenoid kits to make it easier for you. If you want to save money you can make our system work with just about any kind of solenoid, but don't expect it to be a drop-in. Know that how well it works depends on the response characteristics your solenoid happens to have and your ability to quantify them and setup the appropriate compensations.

After you have settled on a solenoid layout you have to tune the controllers so that you are actually controlling what you want to control. This is by far the most difficult setup task and is explained in more detail in later sections. This is why it pays to start out simple and in a controlled manner. We recommend starting off tuning a dome pressure control PID using shop air as the pressure source since you can do that without the engine even running. Even if you don't plan on using this configuration it is worth the time and effort of learning about how to tune a PID this way because of two key things- it is a trial and error process and the cost of error is low. The LAST thing you want to be doing is trying to figure out what a PID is while you are breaking in your cam, trying to figure out if your base fuel map is in the ballpark, or on your maiden voyage. Don't be stupid.

After the controllers are working well you can play around with different ways to set your target- Boost vs. Speed, Boost vs. Time, Boost vs. RPM, etc. This is done based on intended usage and traction availability.

2.0 TURBO & WASTEGATE CONTROL PRIMER (OPTIONAL BACKGROUND MATERIAL)

Equilibrium is a concept that is central to turbocharger and wastegate control. With all of the Holley recommended configurations there is always a mechanical system that will reach equilibrium on its own.

At the most basic level a turbocharger works by recovering energy from the exhaust with a turbine, and then using that energy to power a compressor. When the turbine is making more torque than the compressor requires for the given flow and pressure, the turbo shaft speed will increase. If the turbine is delivering less torque than the compressor requires, the speed will decrease.

With a turbocharger this does not happen instantaneously because there is inertia of the rotating assembly (turbine wheel, shaft, and compressor). It is a dynamic system because the rotating assembly "stores" kinetic energy. Turbo acceleration is in proportion to the difference in torque of the compressor and turbine.

Generally speaking, the power required for the compressor goes up with speed. If you assume you have a constant outlet restriction if you plot compressor power vs. shaft speed you will see that not only increases, but the slope also increases with speed. If you had a power source that delivered a constant torque, as some speed the compressor will use as much power as the source will provide. The source power is equal to the compressor power. If the system started at a higher speed, the compressor would use more power than the source would provide so the system would slow down. If the system started slower, there would be extra power to accelerate the system. This is a simple example of a stable system in equilibrium: a change in the system state will produce a reaction that pushes the system back toward equilibrium. This is called negative feedback and it is important for stability and equilibrium.

A turbocharger will rarely reach equilibrium at a level that is ideal for an engine without some form of regulation. That is what the wastegate does. The non-linearity of the turbine typically means that for most engines at low engine speeds the turbo reaches equilibrium at low boost levels and at high engine speeds the turbo would deliver intolerable levels of boost. The wastegate essentially diverts energy from going through the turbine, which steals power from it. If the exhaust flow from the engine is at some constant level, the more flow vented through the wastegate means that less will go through the turbine. Less flow through the turbine means

less energy to deliver to the compressor. This alters the equilibrium. Imagine that at some engine speed the compressor needs 50hp do drive it at the desired boost level. Perhaps the turbine could deliver 75hp. To operate in equilibrium you are going to have to deal with the 25hp excess. You could put a brake or generator on the turbo shaft. Alternatively, you could just open a hole and let enough exhaust out so that the rest going through the turbine is only delivering 50hp. That is what the aptly named wastegate does. It is akin to regulating the speed of a pneumatic die grinder by controlling an air leak in the hose.

The regulating function of the wastegate occurs because it adjusts the exhaust leakage as a function of boost pressure. When boost is high, it leaks more exhaust out. When boost is low, it reduces the leak.

A wastegate will reach its own equilibrium position because of a force balance primarily between a spring and a gas pressure. Assume for a moment that you have a single port wastegate that has a diaphragm with 3 square inches of area a spring with 30 lbf of preload. Below 10psig of pressure, nothing happens because the spring preload is more than the gas reaction force. Above 10psig of pressure, the gas force starts overcoming the spring. Equilibrium will happen when the gas reaction force matches the spring force, so the displacement will be a function of the spring rate.

A dual port wastegate gives you the ability to affect directly the wastegate's equilibrium by introducing a separate gas reaction force from a control pressure. This is often called "dome" or "top" pressure. It more or less changes the preload in the system so that it requires more boost pressure to unseat the wastegate valve.

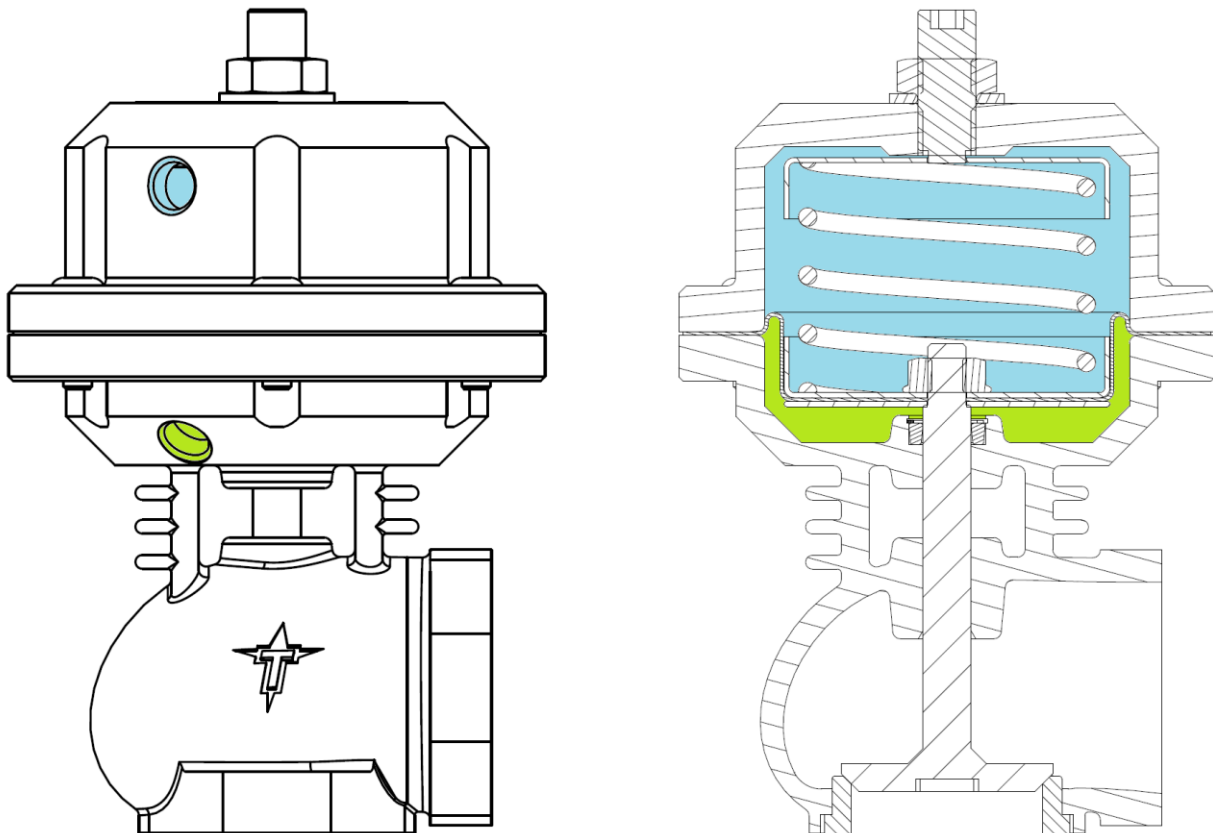

This is a cross section of a Turbonetics Evolution Wastegate that has been colored to highlight the different chambers. The volume above the diaphragm highlighted in blue is what we refer to as the "dome." In dual port wastegate configurations this is the pressure that the Holley ECU actively controls. The volume below the diaphragm that is highlighted in green is connected directly to the compressor discharge pressure. The only exception to this is when the dual port wastegate is used as if it is a single port wastegate. In this case the area in blue is vented to atmosphere and the area in green is controlled by the ECU via a single 3-port solenoid.

The wastegate’s property of more leaking exhaust out as boost pressure increases means that the engine/turbo/wastegate system will reach equilibrium at a relatively constant boost level when there is excess turbine power.

The Holley EFI system modifies the pressure signals that produce the equilibrium, thus altering the resulting equilibrium level. This is typically done by altering pressures going to a mechanical wastegate, which directly affects the level of boost. In this way the Holley EFI system can be used to control boost, and thus the output of a turbocharged engine.

3.0 MAIN CONTROLLER SETUP COMMON TO ALL CONFIGURATIONS

Many of the key configuration parameters are found in the **Boost Setup** tab.

The screenshot displays the Boost Setup tab with the following sections:

- SYSTEM SETUP:**
 - Wastegate Type: Dual Port (Dome pressure control)
 - Solenoid Configuration: Dual Holley
 - Control Method: Dome Pressure Only
 - Operating Mode: Boost vs Time
 - Use Master Enable Input:
- TRANS BRAKE/LAUNCH INPUT:**
 - Trans Brake/ Launch Input Enabled:
 - Launch Target: 5.0 psig
- SPEED INPUT SELECTION:**
 - Speed Input for Boost Control: [Dropdown]
- TPS BOOST MODULATION:**
 - TPS Based Boost Modulation Enable:
 - TPS to Start Modulation Ramp: 50%
- BOOST SCRAMBLE INCREASE:**
 - Boost Scramble Increase:
 - Amount at Apply: 2.0 psig
- BOOST SCRAMBLE DECREASE:**
 - Boost Scramble Decrease:
 - Amount at Apply: 1.0 psig
- SAFETY SETUP:**
 - Boost Pressure Above: 25.0 psig
 - Boost Pressure Above: 20.0 psig For 2.0 sec
 - Boost Error Index: 50.0 For 2.0 sec
 - Dome Pressure Above: 35.0 psig
 - Dome Pressure Above: 30.0 psig For 2.0 sec
 - Dome Error Index: 50.0 For 2.0 sec
 - Switched Output: [Dropdown] Is Active For 30.0 sec
 - Action options: Cut Ignition, Revert to Wastegate, Ignore

Wastegate Type allows you to specify the type of wastegate you have. Currently the options are “Single Port” and “Dual Port (Dome pressure control).” If you don’t have a wastegate yet, we recommend dual port wastegates for their flexibility. You can run a dual port as if it is a single port, but not the other way around.

The **Solenoid Configuration** allows you to specify the type of solenoid configuration. The available options will depend on the **Wastegate Type** that is selected. “Single Holley 3-Port” is preferred for a “Single Port” wastegate type and “Dual Holley 3-Port” is preferred for a “Dual Port (Dome pressure control)” wastegate type. If the **Solenoid Configuration** is set as “Custom” the **Solenoid Dead Time** will appear and should be set. Refer to the section on **Solenoid Dead Time** if you are not using a Holley solenoid. When using a Holley solenoid the deadtime compensation is taken care of automatically.

Control Method specifies what control loops are active. For instance, you may be controlling boost pressure, dome pressure, or nothing (“Open Loop- Duty Cycle” mode). Obviously in all cases what you are ultimately trying to control is boost pressure, but this lets you specify the mechanism of doing so and dictates the meaning of your target curves.

Operating Mode lets you choose how to set the target, with options like “Boost vs. Speed,” “Boost vs. Time,” “Boost vs. Gear,” etc.

If it is desired the boost control functionality can be turned on and off with a switch. This is commonly desired when using a consumable pressure source like CO2. If you check the box for **Use Master Enable Input** there will be a new Master Enable input that becomes configurable in the **Inputs/Outputs** tab. Assign the type of input that is desired (“+12V” means that the boost control will be active when battery voltage is supplied to the input and “GROUND” means that the boost control will be active when the input is grounded) and then assign the input to an available pin in the PINMAP section. If you uncheck the box for **Use Master Enable Input** the boost control functionality will automatically activate any time there is a boost demand over 0.5psi. We DO NOT recommend cutting the power to the vent solenoid for a makeshift on/off control if you are using a dual solenoid configuration. The reason is that the solenoids will trap pressure when the wastegate opens if they are not plugged in. If the solenoids are both closed and the wastegate opens the movement of the diaphragm or plunger will reduce the volume of the dome space resulting in an increase in pressure. For safety’s sake even if the **Use Master Enable Input** turns the boost control off, it will still open the vent solenoid if the measured dome pressure rises above 0.5psi. This will bleed any trapped pressure in the dome if the wastegate moves. This insures that the resultant boost will not be substantially higher than the level that would be reached if the dome were vented to atmosphere. This is not so important with single solenoid systems because they are intrinsically biased to result in low boost when deactivated.

If the **Operating Mode** is set to “Boost vs. Speed” you will need to specify the source of the vehicle speed through the **Speed Input for Boost Control** parameter. This speed sensor should be setup in the IO or Trans ICF and have units of MPH to be visible in the picklist. It is not setup in the **Inputs/Outputs** tab of the Boost ICF.

TPS Based Boost Modulation Enable allows the TPS to modify the boost target so that the driver can modulate boost demand by using the throttle. When **TPS Based Boost Modulation Enable** is active the boost target will be zero when the TPS is less than the value of **TPS to Start Modulation Ramp**, at the full boost demand (from the curves) when the TPS is greater than 95%, and is linearly interpolated in between. We recommend utilizing the TPS based boost modulation functionality in nearly all applications.

TPS Based Boost Modulation Example
Curve Value 10psig, Start Ramp 50%

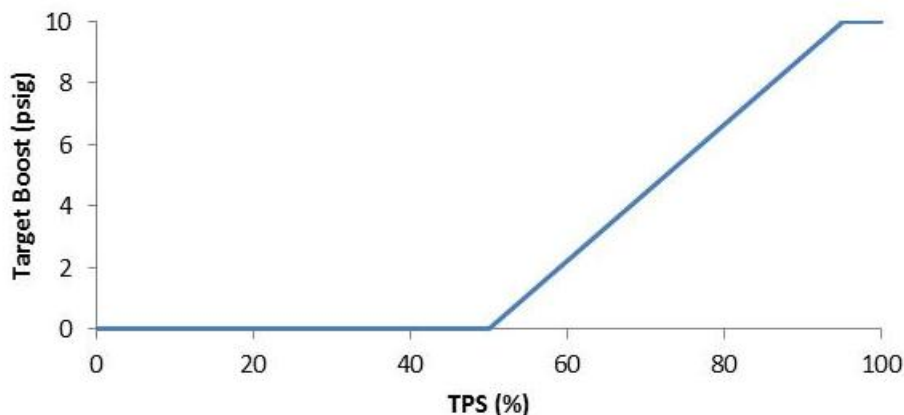

Trans Brake/Launch Input Enable allows a switched input to override the boost target from the curve with that which is specified by the **Launch Target** parameter as well as establish the beginning time for the “Boost vs. Time” operating mode. This boost target is also subject to modulation if **TPS Based Boost Modulation Enable** is active. The value in **Launch Target** has the same units as your other boost curves. If you are running “Dome Only”, then this will set the dome pressure demand when the **T-Brake/Launch** input is active. If you are running “Open Loop – Duty Cycle”, then this will set the duty cycle when the **T-Brake/Launch** input is active. When **Trans Brake/Launch Input Enable** is checked there will be a **T-Brake/Launch** input that shows up in the **Inputs/Outputs** tab. It is here that you select the active state of the input. In other words it specifies if the input is active when it is grounded or active when it is fed with battery voltage. It will then be available in the PINMAP section to assign to an available input pin. Note that the target boost will be determined by the **Launch Target** parameter when the **T-Brake/Launch** input is active. The “launch” occurs when the **T-Brake/Launch** input goes from the active to the inactive state signaling the release of the brake. That is what starts the timers. Note: do not hook any ECU input up in parallel with a high current solenoid like a trans brake. The deactivation of the device will create a large voltage spike as the current decreases, which can damage the ECU’s inputs. The recommended practice is to put a relay between the trans brake and the ECU, where the relay’s coil is wired across (in parallel with) the trans brake solenoid and the contacts of the relay generate a clean +12V or Ground output for the ECU’s input.

Boost Scramble Increase enable allows a switched input to add a constant value (defined by **Amount at Apply**) to the boost target. This increase in boost demand will be active so long as the associated input is active and will go away when the input goes inactive. It is probably more intuitive to think of it as “amount DURING apply.” When **Boost Scramble Increase** enable is checked there will be a **Boost Scramble +** input that shows up in the **Inputs/Outputs** tab. It is here that you select the active state of the input. In other words it specifies if the input is active when it is grounded or active when it is fed with battery voltage. It will then be available in the PINMAP section to assign to an available input pin. **Boost Scramble Increase** does not modify the boost target when the **T-Brake/Launch** input is active.

Boost Scramble Decrease enable allows a switched input to subtract a constant value (defined by **Amount at Apply**) to the boost target. This decrease in boost demand will be active so long as the associated input is active and will go away when the input goes inactive. It is probably more intuitive to think of it as “amount DURING apply.” When **Boost Scramble Decrease** enable is checked there will be a **Boost Scramble -** input that shows up in the **Inputs/Outputs** tab. It is here that you select the active state of the input. In other words, it specifies if the input is active when it is grounded or active when it is fed with battery voltage. It will then be available in the PINMAP section to assign to an available input pin. **Boost Scramble Decrease** does not modify the boost target when the **T-Brake/Launch** input is active.

Any configuration will have at least one output solenoid. In the **Inputs/Outputs** tab there is a section that will allow you to specify “PWM+” or “PWM-“ for the output type.

3.1 BOOST SAFETY SYSTEM

In order to protect the engine, vehicle, and driver there is a safety system integrated into the boost control ICF that will allow you to assign actions to user defined error conditions. It is certainly possible when setting up the boost control ICF for boost pressure or dome pressure to become out of control for a variety of reasons. Hose connection failures, electrical faults, or bad tuning could all cause the system to reach a boost level that would be intolerable to the engine, the turbo, or traction conditions. For this reason we have defined a set of conditions with user adjustable thresholds that will allow you to manage the response of the system.



Each of these conditions has a user selectable action associated with it: "Ignore", "Revert to Wastegate", or "Cut Ignition." If "Ignore" is selected as the action, no action will be taken if the error condition is met. If "Revert to Wastegate" is selected as the action the ECU will command the boost control solenoids to result in the lowest boost possible. At this point the boost will be entirely determined by the mechanical wastegate system if it is operational. When the "Revert to Wastegate" action is invoked normal control will resume when the $TPS < 10$ for 3 seconds. Because there are a category of failures that have more severe failure modes the option is given to "Cut Ignition." For instance if you are running a dual port wastegate and the line blows that connects the compressor discharge pressure to the bottom of the wastegate, the system will not reach equilibrium at a normal boost pressure because the mechanical control system (innermost loop) is compromised. In this case it is good to have an option to shut things down as quickly as possible to prevent damage. When the "Cut Ignition" action is invoked normal control will resume when the $TPS < 10$ for 3 seconds OR engine speed falls below 2500RPM. This can result in a sawtooth oscillation if you maintain WOT, but it should get your attention.

There are three conditions that allow you to define a response to errors in boost pressure. This is manifold pressure, not dome pressure. The safety can be used even if you are not controlling boost pressure ("Dome Pressure Only" or "Open Loop - Duty Cycle" for instance). The first condition is met when the boost pressure exceeds the user defined threshold for any length of time. So if you setup **Boost Pressure Above** "30.0 psig" "Cut Ignition," as soon as boost hits 30 psig it will cut the ignition. The second condition is met when the boost pressure exceeds the user defined threshold for a user defined length of time. So if you setup **Boost Pressure Above** "15.0 psig" for "2.0 sec" "Revert to Wastegate," then the boost pressure will have to be greater than 15 psig for at least 2 sec uninterruptedly before the boost pressure control solenoids will be commanded to lowest possible boost. The time condition is added to desensitize the system safety to short spikes, which allows you to specify a boost threshold that is closer to your actual target with a lower risk of unwanted activation. The third condition will react to the *Boost Error Index* being greater than a user defined threshold for a user defined length of time.

There are three conditions that allow you to define a response to errors in dome pressure. This is not to be confused with boost pressure in the manifold. The first condition is met when the dome pressure exceeds the user defined threshold for any length of time. So if you setup **Dome Pressure Above** "30.0 psig" "Cut Ignition," as soon as dome hits 30 psig it will cut the ignition. The second condition is met when the dome pressure exceeds the user defined threshold for a user defined length of time. So if you setup **Dome Pressure Above** "15.0 psig" for "2.0 sec" "Revert to Wastegate," then the dome pressure will have to be greater than 15 psig for at least 2 sec uninterruptedly before the boost pressure control solenoids will be commanded to lowest possible boost. The time condition is added to desensitize the system safety to short spikes, which allows you to specify a dome threshold that is closer to your actual target with a lower risk of unwanted activation. The third condition will react to the *Dome Error Index* being greater than a user defined threshold for a user defined length of time.

There is one condition with even greater flexibility that allows the user to pick a switched output to monitor. In this case you can define your own switched output that corresponds to a condition to which you wish to react, a time that the condition must be met before action is taken, and the action that would be taken when the condition is met. It is important to realize that you do not have to use a physical output of the ECU for the channel to be used. For instance you could setup a switched output called "LowFuelPressure" that is active when $MAP > 150kPa$ and $Fuel\ Pressure < 40psig$ and select that output to use in the boost safety function to cut the ignition if this is true for more than 0.5 second.

4.0 SINGLE PORT WASTEGATE CONTROL

The Holley system operates single port wastegate systems by reducing the effective pressure between the compressor discharge and the wastegate. A single port wastegate system will reach equilibrium at a relatively constant wastegate control pressure. So any device that supplies the wastegate by reducing (or dividing) the compressor discharge pressure will change the boost pressure that is reached at equilibrium. For example, assume you have a system with the wastegate connected directly to the compressor discharge that stabilizes at 8psig of boost. If you introduce something that causes a 2psi pressure drop between the compressor discharge and the wastegate, the wastegate control pressure would still reach 8psig at equilibrium but the boost would settle to 10psig. The Holley system controls a single port wastegate with a single three-port solenoid, which effectively reduces or "divides down" the compressor discharge pressure in a controllable way.

For a given solenoid duty cycle the average output pressure is roughly a fixed fraction of the input pressure. Assume that for a 30% duty cycle the average output pressure is 80% of the input pressure. Consider the previous example of the system that reaches natural equilibrium at 8psig. If you put this solenoid (operating at 30%) between the compressor discharge pressure and the wastegate, the reduction will cause the compressor discharge pressure to reach equilibrium at roughly 10psig. $8psig / 0.8 = 10psig$. The solenoid effectively "levers up" the boost by the reduction in control pressure. The nice part about using an electronically controlled solenoid is that the "lever ratio" can be changed on the fly. This is obviously very useful if you want the boost to be at different levels depending on engine speed, gear, or time since launch. If at a different duty cycle the solenoid reduces the pressure by 50%, then the boost would go up to roughly 16psig. $8psig / 0.5 = 16psig$.

The word "roughly" in the previous examples is used because pre-turbine pressure also has a direct influence on the wastegate's operation since it exerts a force on the wastegate valve. The significance of this influence is determined by a number of factors and is not always easy to predict since there is not always a linear relationship between boost pressure and pre-turbine pressure. In the extreme case (large wastegate valve area, low spring preload, small A/R turbine housings) the pre-turbine pressure can open the wastegate before the target boost is reached even with zero control pressure. In this case, if the mechanical control system has reached its limits, the Holley boost control system has no control authority with which to function.

The Holley system offers two methods to control a single port wastegate with a three port solenoid. The first method utilizes a PID controller to a target boost pressure (closed loop control) and the second method allows you to dictate explicitly the solenoid duty cycle (open loop control). The first method allows you to define boost target values (in psig) along with a base boost demand to duty cycle map and the PID controller will tweak the duty cycle to get the right boost. The advantage of utilizing the PID controller is that it will be more robust to environmental disturbances (baro, temp, battery voltage, etc.) but it will require some level of understanding about the application of PID controllers. The second method allows you to define explicitly the duty cycle that you want. This can be useful if you are migrating from a duty cycle based control scheme or have a system that is too transient to allow for acceptable PID performance. You have the most control, but there are fewer active safeguards. The system will do exactly what you tell it. If the duty cycle you enter will result in overboost, you will get overboost.

Both recommended control methods for a single port wastegate utilize a single Holley three-port solenoid. The "3" port (normally open) should be connected to the compressor discharge pressure (upstream of the throttle), the "2" port should be connected to the wastegate, and a silencer should be installed in the "1" port (normally closed) or left open. Just to reiterate, if the solenoid is unplugged you should be able to blow through port

connecting to the compressor (3) to the port connected to the wastegate (2), but not from the wastegate port (2) to the vent port (1). When the solenoid is not energized the boost pressure should be purely a function of the wastegate.

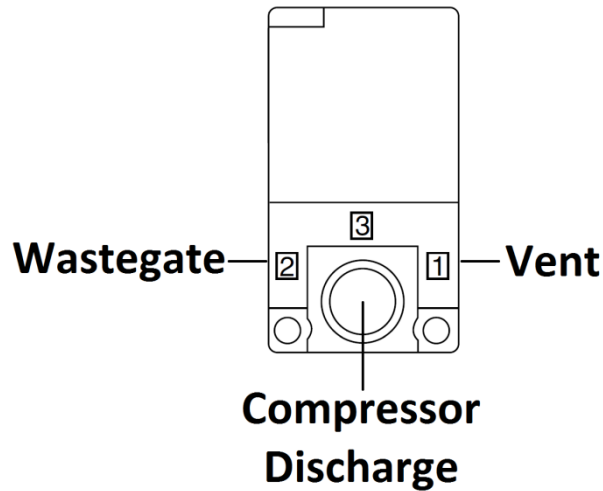

Port 1- Vent to atmosphere

Port 2- Wastegate

Port 3- Compressor discharge (before throttle)

We do not recommend using a dual solenoid configuration that will hold pressure when the solenoids are inactive. No other boost control device should be installed in the wastegate pressure control circuit. Preferably, the plumbing for the wastegate control should be dedicated. Nothing should “tee” into it which would create a pressure drop or dynamically interfere with the pressure signals.

If you are using a non-Holley 3-port solenoid it must be wired and plumbed such that the wastegate gets full pressure when the solenoid is 0% duty cycle. An increase in duty cycle should reduce the pressure on the wastegate. If you have any doubt put compressed air (of reasonable pressure) to the solenoid where the compressor discharge would go. This should open the wastegate and not spill out the vent.

While you could theoretically implement a single solenoid “bleed” type system, as of the time of this publication the Holley control system has not been validated with this configuration. The 3-port solenoids are recommended because they inherently have more authority and controllability.

For reference, it is possible to use a dual port wastegate as if it were a single port wastegate. In this case the dome of the dual port wastegate is left open and the bottom pressure is modulated via a 3-port solenoid.

4.1 APPLICATION OF A SINGLE PORT WASTEGATE WITH AN “OPEN LOOP-DUTY CYCLE” CONTROL METHOD

What you will see in a single port wastegate system with a single three-port solenoid is that there is a natural correlation between solenoid duty cycle and boost pressure which varies a bit with engine speed. The idea of using “Open Loop- Duty Cycle” control is that you have complete control of the solenoid duty cycle. You know what boost you want, you know what duty cycle this corresponds to, and you are willing to live with whatever happens because nothing is going to override your demand. This can be useful if you are migrating from a duty cycle based control scheme or have a system that is too transient to allow for acceptable PID performance. All of the normal curves (Boost vs. Speed, Boost vs. Time, Boost vs. Gear, etc.) can be used to specify the target duty cycle via **Operating Mode**. There is no base table to translate boost demand to duty cycle, nor is there a PID controller to make duty cycle adjustments. The duty cycle you put in the demand curves is the duty cycle

you get. The only thing that applies a correction to the curve values is the battery voltage compensation. This is done in an attempt to get more repeatable boost when battery voltage varies. If you do not even want that, you can deactivate that feature by setting up the **Solenoid Configuration** as “Custom” (even though you might actually be running a Holley solenoid) and zero the **Solenoid Dead Time** curve. At that point, you have full control and full responsibility.

The most important thing about tuning with the “Open Loop- Duty Cycle” method is to remember not to extrapolate too far since the boost vs. duty cycle curve is quite nonlinear. To avoid potential overboost situations it is imperative to start out slow and carefully keep track of the run history to get a good understanding of the shape of the curve. Nothing will rescue you from overboost if you get it wrong.

Running open loop also becomes riskier if your system has significantly different boost vs. duty cycle curves at different engine speeds. Be aware that using an **Operating Mode** like “Boost vs. Time” opens the door for getting out of sync with your normal run in the event you have hiccups along the way. For instance, assume that at 3.8s you would normally be at 6500RPM and 50% duty cycle. If for some reason you are at 4000RPM at 3.8s because of an early setback, the “normal” 50% duty cycle could result in an unexpected boost at that engine speed.

As is the case with the “MAP Pressure” control method, the solenoid needs to be installed such that activation increases boost (0% duty cycle is lowest boost).

Boost Control
 Single Port Wastegate- Single Solenoid
 Manifold Pressure Control: Not Used
 Dome Pressure Control: Not Used
 Use with caution. System does not react to boost error.

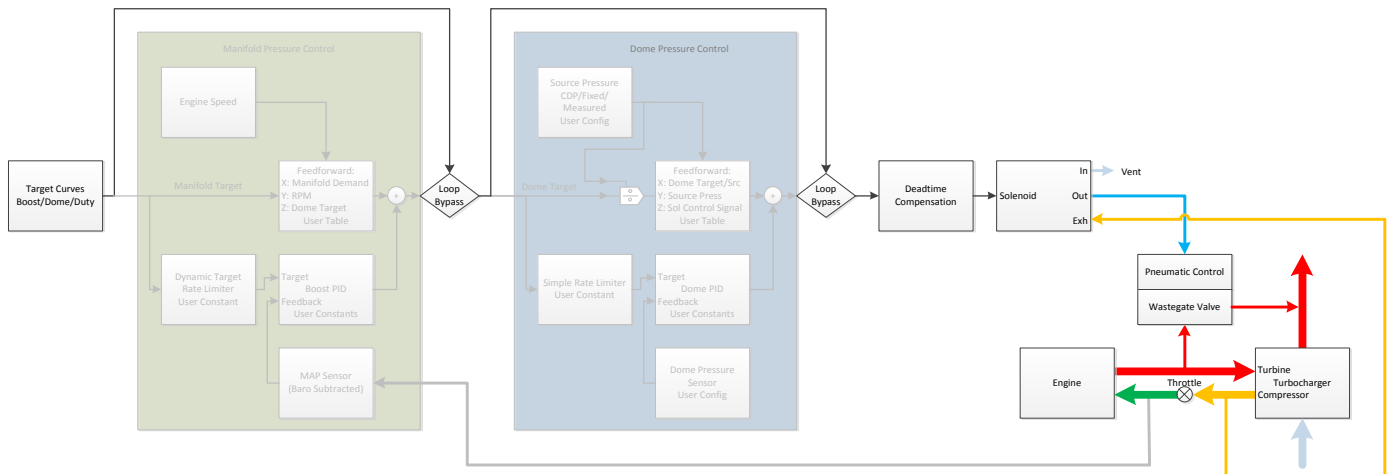

This is a diagram of the system with a single port wastegate running open loop. Both the MAP control and the dome pressure control loops are bypassed.

4.2 APPLICATION OF A SINGLE PORT WASTEGATE WITH A “MAP PRESSURE” CONTROL METHOD

What you will see in a single port wastegate system with a single three-port solenoid is that there is a natural correlation between solenoid duty cycle and boost pressure. This correlation can sometimes vary with engine speed. The objective is to capture this relationship in the **Base Duty Cycle Table** in the **MAP Control Setup**. The **Base Duty Cycle Table** does not contain boost targets. It contains the duty cycles that you need to get the boost you want. Only after establishing a good **Base Duty Cycle Table** should you go on to PID tuning.

CONTROLLER SETUP

P Term
I Term
D Term

Target Rate Limiter
Activation Threshold

BASE DUTY CYCLE TABLE

Target Boost [PSIG]	Duty Cycle [%]															
	0	500	1000	1500	2000	2500	3000	3500	4000	4500	5000	5500	6000	6500	7000	7500
15.6	47.9	47.9	47.9	47.9	47.9	47.9	47.9	48.8	50.0	51.5	54.2	60.7	73.3	73.3	73.3	73.3
15.5	47.9	47.9	47.9	47.9	47.9	47.9	47.9	48.8	50.0	51.5	54.2	60.7	73.3	73.3	73.3	73.3
15.4	47.9	47.9	47.9	47.9	47.9	47.9	47.9	48.8	50.0	51.5	54.2	60.7	73.3	73.3	73.3	73.3
15.3	47.9	47.9	47.9	47.9	47.9	47.9	47.9	48.8	50.0	51.5	54.2	60.7	73.3	73.3	73.3	73.3
15.2	47.9	47.9	47.9	47.9	47.9	47.9	47.9	48.8	50.0	51.5	54.2	60.7	73.3	73.3	73.3	73.3
15.1	47.9	47.9	47.9	47.9	47.9	47.9	47.9	48.8	50.0	51.5	54.2	60.7	73.3	73.3	73.3	73.3
15.0	47.9	47.9	47.9	47.9	47.9	47.9	47.9	48.8	50.0	51.5	54.2	60.7	73.3	73.3	73.3	73.3
14.0	45.9	45.9	45.9	45.9	45.9	45.9	45.9	46.4	47.1	48.2	50.2	55.4	65.6	65.6	65.6	65.6
13.0	43.8	43.8	43.8	43.8	43.8	43.8	43.8	44.0	44.1	45.0	46.2	50.2	57.9	57.9	57.9	57.9
12.0	41.8	41.8	41.8	41.8	41.8	41.8	41.8	41.5	41.1	41.7	42.2	45.0	50.2	50.2	50.2	50.2
11.0	39.4	39.4	39.4	39.4	39.4	39.4	39.4	38.3	37.3	37.4	37.6	39.6	42.5	42.5	42.5	42.5
10.0	34.5	34.5	34.5	34.5	34.5	34.5	34.5	33.6	32.8	32.0	31.9	33.2	34.8	34.8	34.8	34.8
9.0	29.4	29.4	29.4	29.4	29.4	29.4	29.4	28.4	27.4	25.3	25.1	25.5	26.1	26.1	26.1	26.1
8.0	22.2	22.2	22.2	22.2	22.2	22.2	22.2	21.2	20.3	13.0	10.4	6.8	1.4	1.4	1.4	1.4
7.0	0.7	0.7	0.7	0.7	0.7	0.7	0.7	10.0	10.0	0.0	0.0	0.0	0.0	0.0	0.0	0.0
0.0	0.0	0.0	0.0	0.0	0.0	0.0	0.0	0.0	0.0	0.0	0.0	0.0	0.0	0.0	0.0	0.0

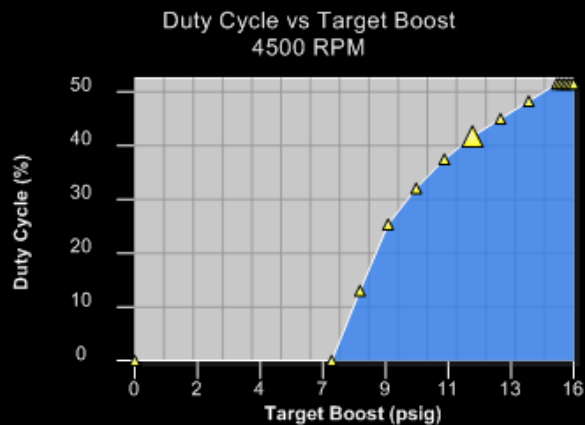
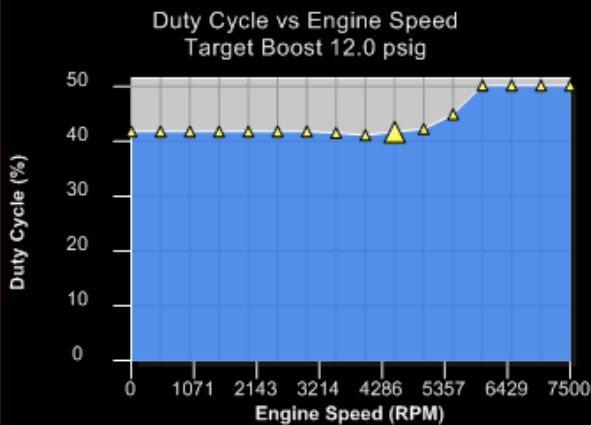

Consider this data from a Holley lab vehicle. At 0% duty cycle the output is equal to the input so there is no pressure reduction. In this case, the system responds like a traditional mechanical wastegate. When the duty cycle is increased the solenoid creates more of a pressure drop which increases the resultant boost. What you can also see is that this is certainly not a linear relationship. At high boost levels the system can be very sensitive to duty cycle. We acquired this data by doing multiple runs on the chassis dyno with a fixed duty cycle **Base Duty Cycle Table** and zeros for the PID controller's **P Term**, **I Term**, and **D Term**. In other words, we ran it with 0% in the entire **Base Duty Cycle Table**, then ran it at 10%, then ran it at 15% etc. until we got a feel for the sensitivity and mapped out the range of interest. For many applications, the curve will not vary too much for different engine speeds. We took all of the DL files from the dyno pulls at different duty cycles and looked at one engine speed at a time. Take for instance 3000RPM. We noted the boost when the duty cycle

was at 0%, then at 10%, then at 15%, etc. When we plotted this out we saw the datapoints formed a curve. Then we slightly smoothed that curve and used it to come up with the values that should be in the **Base Duty Cycle Table** for that engine speed. The input to the **Base Duty Cycle Table** is target boost and engine speed, so your points will not line up exactly. Measured data rarely lines up perfectly with a table's support points. That is why it is important to visualize the shape of one curve at a time so you can interpolate intelligently- whether you fit curves visually or mathematically. We did the same thing for the next engine speed and so on until we filled out the range.

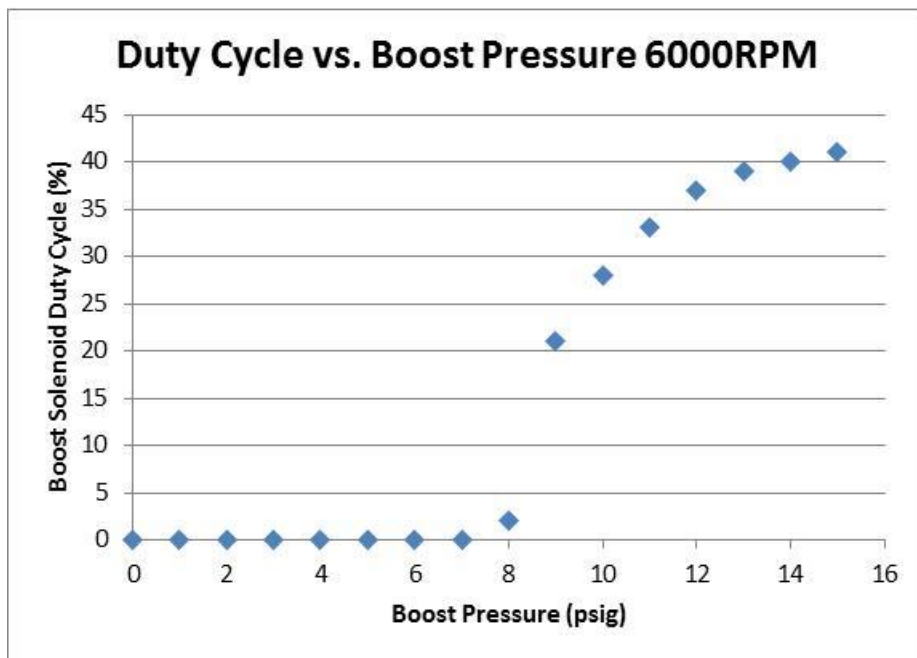
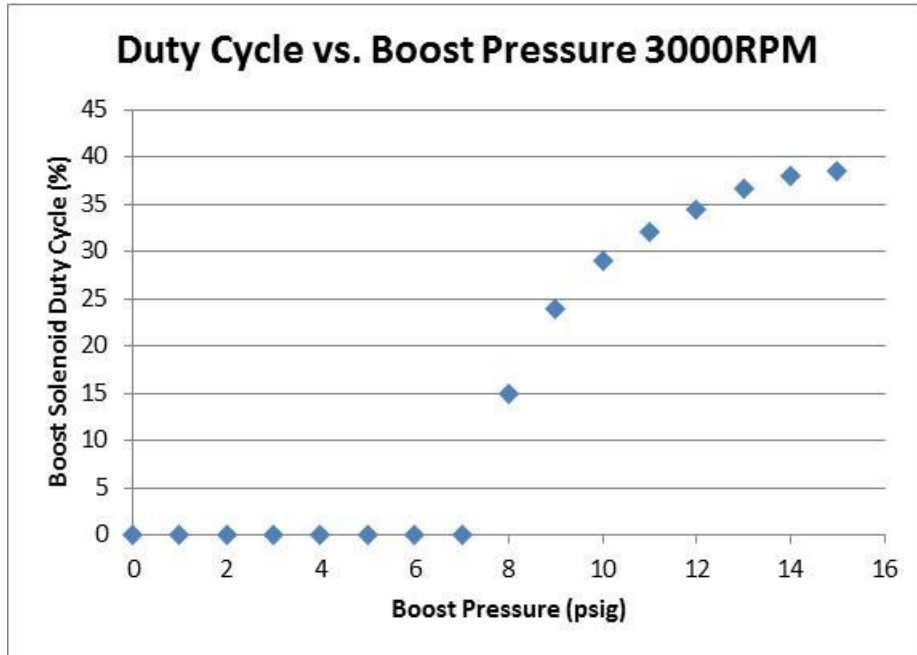

Try to insure that the table is relatively smooth. Obviously, there will be an abrupt change in curvature as you approach 0% duty cycle, but jaggedness in the **Base Duty Cycle Table** can cause oscillation and instability. It is important to realize that this table does not react to what boost actually is- it only gives an estimation of what the duty cycle should be for a given boost target. It is the open loop component. The PID controller is what reacts to the difference between the target boost and the actual boost. Once this table is established you can start increasing the PID terms to make the controller react to error in boost.

The PID controller will only activate when certain conditions are met. Essentially the idea is not to activate the controller until the controller can affect the feedback. Because of this, there is a boost based **Activation Threshold**. This can be set at a value that is close to the “natural” boost of the system when the solenoid is not active. In other words if the wastegate would not open until 8psig, there is no reason for the PID to be active until you get close to this level. We recommend starting with the wastegate’s “spring” pressure. This helps prevent overshoot that can happen when the PID controller is activated too early. One thing to remember about this mode is that in order to achieve the best transient response the solenoid duty cycle is fixed to 100% (the wastegate receives no pressure) until the **Activation Threshold** is reached. This is a good reason not to set it too high. The closer you set the **Activation Threshold** to your target boost, the greater the chance you will get overshoot. Setting the **Activation Threshold** higher than your target boost (inclusive of **Launch Target**) is not a smart thing to do and can cause fairly severe cycling. For initial development of the **Base Duty Cycle Table** we advise setting the **Activation Threshold** to a low value (less than half of the boost level “on the gate”).

The **Target Rate Limiter** is also another tool to control overshoot when boost is building. Even if the wastegate is completely closed the boost will only build at a certain rate because of the turbo system’s inertia, therefore it is unreasonable to expect the boost to rise faster than this. The **Target Rate Limiter** establishes how fast the boost target for the PID controller will increase. Since this is specifically to prevent overshoot due to PID windup, the **Target Rate Limiter** is not applied to the boost target for the **Base Duty Cycle Table**. The **Target Rate Limiter** will not limit the rate when boost is below the **Activation Threshold**, but will activate when the boost value reaches this threshold.

The optimum PID tuning is different for every system, therefore you should expect to put some effort into tuning these parameters. We do not force you to use our best guess. You have the liberty to make the PID control as stable or aggressive as you wish. There is some general advice specific to PID controller tuning in a later section.

One slight disadvantage of the non-linearity that comes with the single-port wastegate control is that the optimum PID tuning actually changes depending on your boost target. Practically speaking you will want to tune such that you are not too aggressive at high boost, even though that means the tuning might be a little slow at low boost. That means if you keep pushing up your boost levels into new territory, you might have to reduce your PID values.

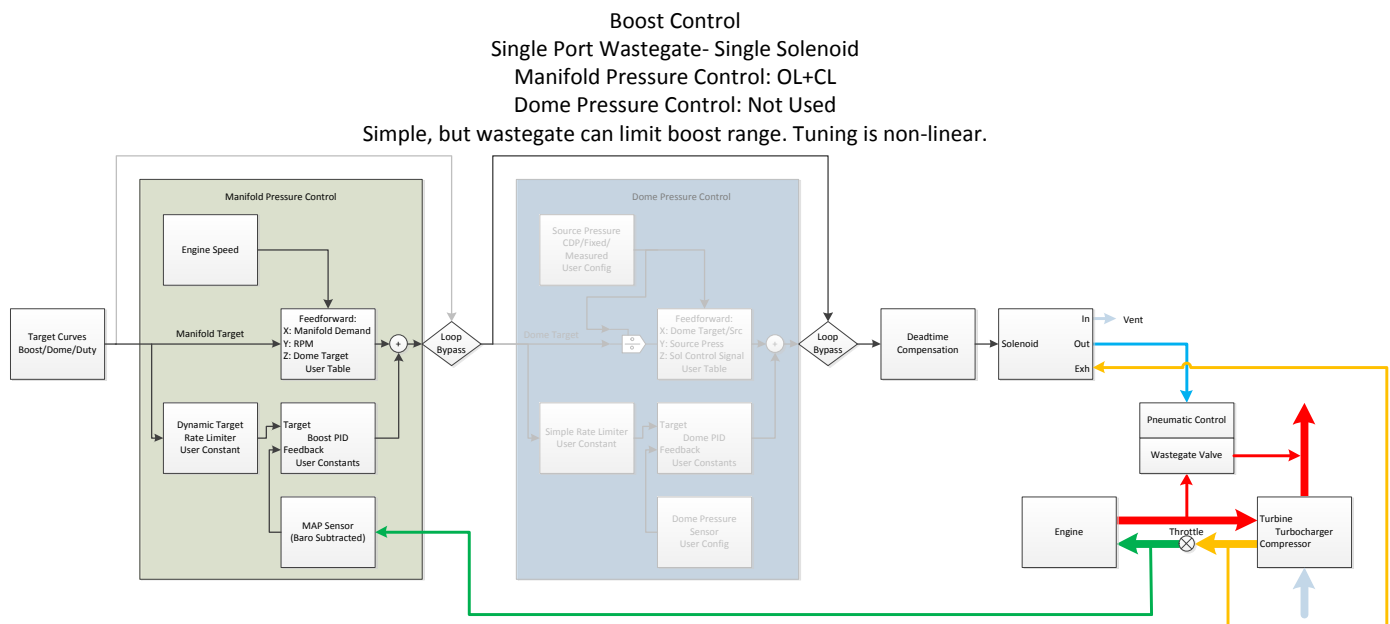

This is a diagram of the system with a single port wastegate running open loop. The MAP control section is used and the dome pressure control loop is bypassed.

5.0 DUAL PORT WASTEGATE CONTROL

The Holley system controls boost with dual port wastegates by controlling the “dome” pressure. The “bottom” port of the wastegate connects to a dedicated, unrestricted compressor discharge pressure source. When the dome pressure is zero (left open to atmosphere), a system with a dual port wastegate will also reach equilibrium at some boost level. This is often called the “spring” pressure or the “opening” pressure of the wastegate. Increasing the dome pressure will directly increase the equilibrium boost level. As with single port wastegates, pre-turbine pressure is also a factor. With dual port wastegates this typically means that boost pressure does not go up 1:1 with dome pressure. In other words, you may need to increase the dome pressure by 4psi to get the boost pressure to go up 3psi. This ratio will also change with engine speed as well. Consider some data from a Holley development vehicle. Notice how at lower engine speeds the ratio is closer to 1:1 while at higher engine speeds a 12psi change in dome pressure only resulted in a roughly 8psi change in boost pressure.

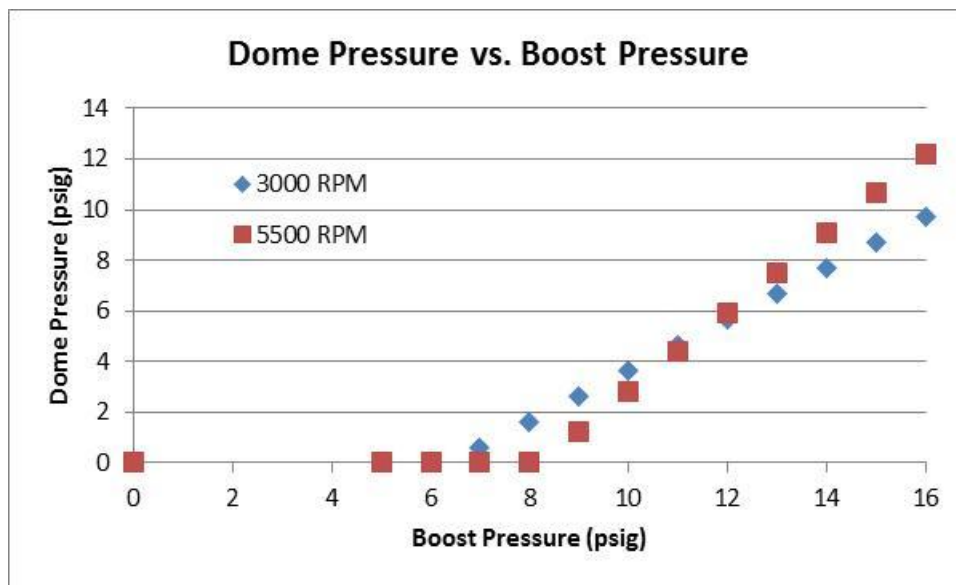

When using a dual port wastegate you have three choices when it comes to the **Control Method**: “MAP and Dome Pressure,” “Dome Pressure Only,” and “Open Loop- Duty Cycle.” The “MAP and Dome Pressure” method is the most complex in application with two nested controllers, but it allows you to control boost pressure directly and is the most robust to environmental disturbances. It requires the most knowledge of controller tuning to avoid oscillation. The “Dome Pressure Only” method is a middle ground in which the complexity is limited by indirectly controlling boost with dome pressure. Many popular aftermarket controllers operate similarly to our “Dome Pressure Only” control method. The “Open Loop- Duty Cycle” method is the least complex, which works by controlling dome pressure “open loop” with duty cycle and indirectly controlling boost with dome pressure. It requires no knowledge of controller tuning but has the fewest safeguards and is the most susceptible to disturbances.

Practically speaking it is often expedient to start with the “Dome Pressure Only” method. If that meets your needs, great- there is no need to add complexity. If you want to do direct boost control, what you learn with “Dome Pressure Only” is directly applicable. Use “Open Loop- Duty Cycle” only as a last resort.

Adjusting by screw displacement or by shims will alter the boost pressure vs. dome pressure curves. Because of this it, is desirable to leave the physical system alone as much as possible and use the electronic settings to tune. It is much like tweaking fuel pressure to “tune,” which results in shifting the fuel delivery vs. energizing time curve for your injectors. It may accomplish what you want, but when you do that, you essentially throw out

what you have already learned. Once you verify that you can reach your targets, try to leave the wastegate alone so that you can build on your knowledge base of previous runs.

5.1 APPLICATION OF A DUAL PORT WASTEGATE WITH AN “OPEN LOOP- DUTY CYCLE” CONTROL METHOD

What you will see in a dual port wastegate system with a single three-port solenoid for dome pressure control is that there is a natural correlation between solenoid duty cycle and boost pressure which varies a bit with engine speed. This is because there is a correlation between duty cycle and average output pressure for a constant supply pressure, and a correlation between average output pressure (dome pressure) and boost. The idea of using “Open Loop- Duty Cycle” control is that you have complete control of the solenoid duty cycle. You know what boost you want, you know what duty cycle this corresponds to, and you are willing to live with whatever happens because nothing is going to override your demand. This can be useful if you are migrating from a duty cycle based control scheme or have a system that is too transient to allow for acceptable PID performance. All of the normal curves (Boost vs.Speed, Boost vs. Time, Boost vs. Gear, etc) can be used to specify the target duty cycle via **Operating Mode**. There is no base table to translate boost demand to duty cycle, nor is there a PID controller to make duty cycle adjustments. The duty cycle you put in the demand curves is the duty cycle you get. The only thing that applies a correction to the curve values is the battery voltage compensation. This is done in an attempt to get more repeatable boost when battery voltage varies. If you do not even want that, you can deactivate that feature by setting up the **Solenoid Configuration** as “Custom” (even though you might actually be running a Holley solenoid) and zero the **Solenoid Dead Time** curve. At that point, you have full control and full responsibility.

If you are going to use the “Open Loop- Duty Cycle” method with a dual port wastegate, we recommend using “Single Holley 3-Port” for the **Solenoid Configuration** with an external constant pressure source. Mind the source pressure. The accuracy of the control depends on the stability and repeatability of the source pressure, since there will be no compensation for divergence. The “1” port should be connected to the external pressure source, the “2” port should be connected to the wastegate, and a silencer should be installed in the “3” port (or left open). The bottom chamber of a dual port wastegate always goes to compressor discharge pressure.

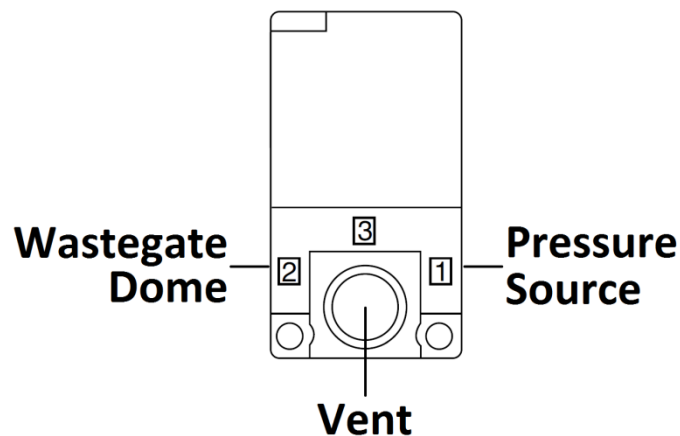

Port 1- Constant Pressure Source

Port 2- Wastegate Dome

Port 3- Vent to atmosphere

We do not recommend using a dual solenoid configuration that will hold pressure when the solenoids are inactive. We do not recommend using a single solenoid configuration that uses the compressor discharge pressure for the pressure source, as that can lead to instability in some circumstances and in the very least is plagued with a lack of repeatability. No other boost control device should be installed in the wastegate

pressure control circuit. Preferably, the plumbing for the wastegate control should be dedicated. Nothing should “tee” into it which would create a pressure drop or dynamically interfere with the pressure signals.

The most important thing about tuning with the “Open Loop- Duty Cycle” method is to remember not to extrapolate too far. It is not quite as sensitive as open loop with a single port wastegate, but to avoid potential overboost situations it is imperative to start out slow and carefully keep track of the run history to get a good understanding of the shape of the curve. Nothing will rescue you from overboost if you get it wrong. Running open loop also becomes riskier if your system has significantly different boost vs. duty cycle curves at different engine speeds. Be aware that using an **Operating Mode** like “Boost vs. Time” opens the door for getting out of sync with your normal run in the event you have hiccups along the way. For instance, assume that at 3.8s you would normally be at 6500RPM and 50% duty cycle. If for some reason you are at 4000RPM at 3.8s because of an early setback, the “normal” 50% duty cycle could result in an unexpected boost at that engine speed.

As a side note there is a practical reason not to use this configuration. A single three port solenoid needs a constant pressure source uses a lot of air (or CO2). If you have a dual port wastegate and you really, really don't want to buy the extra sensor to do full dome pressure control- just run your wastegate as if it is a single port. Leave the dome open, run the solenoid controlled pressure to the bottom of the wastegate, and follow instructions for a single port wastegate.

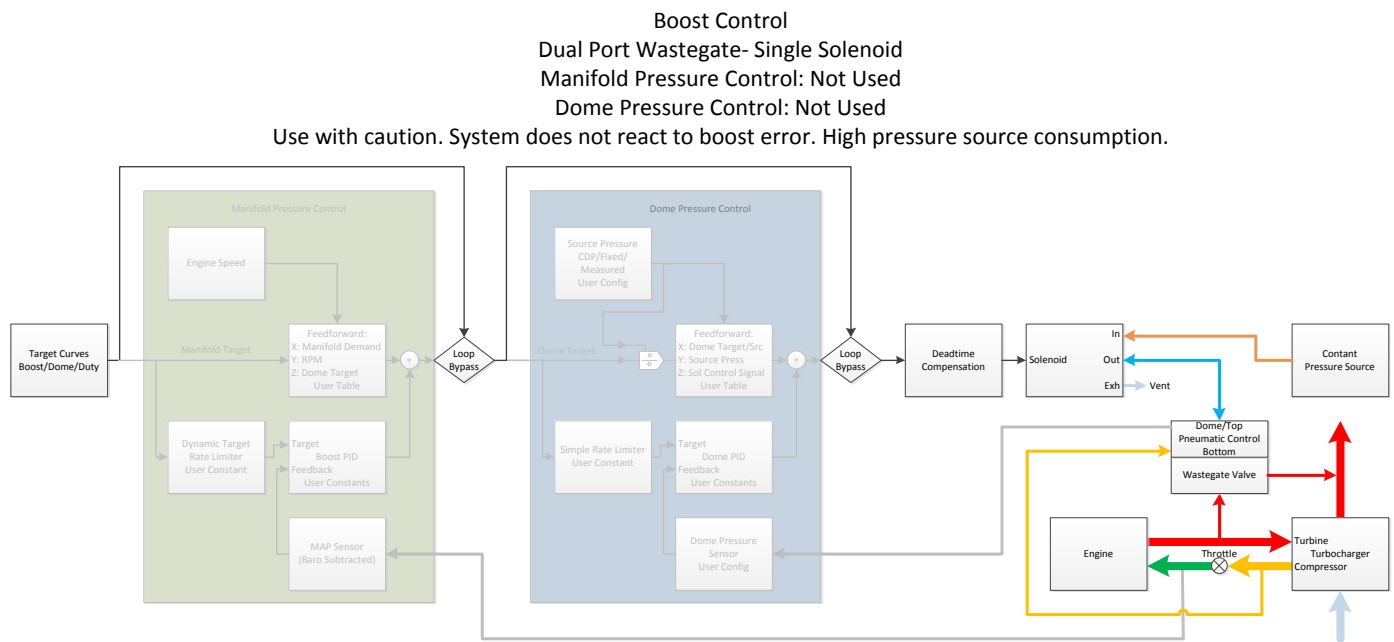

This is a diagram of the system with a dual port wastegate running open loop. Both the MAP control and the dome pressure control loops are bypassed.

5.2 APPLICATION OF A DUAL PORT WASTEGATE WITH A “DOME PRESSURE ONLY” CONTROL METHOD

The “Dome Pressure Only” method is a compromise that is usually fairly easy to tune while avoiding some of the key pitfalls of a completely open loop scenario. Again, you are indirectly controlling boost via a direct control of dome pressure, so all of your target values are in terms of dome pressure and not boost pressure. You have to be aware of your engine’s boost vs. dome pressure relationship and set dome pressure accordingly. Having a dome pressure controller also introduces the possibility of using different pressure sources and the accuracy does not entirely hinge on the pressure source’s repeatability. It is also a structure that is tolerant to multiple solenoid configurations. Since there is only one PID controller active, the boost is

somewhat more stable at a slight expense of steady state accuracy. If the system is highly transient, the gain in stability may outweigh any potential benefits in accuracy.

5.2.1 Dual Solenoid Setup

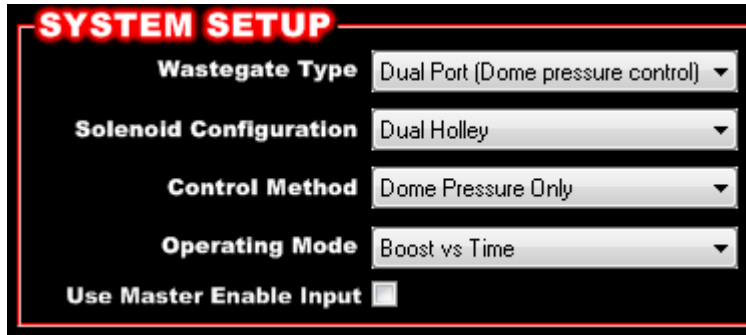

If you are going to use the “Dome Pressure Only” method with a dual port wastegate, we recommend using “Dual Holley” for the **Solenoid Configuration** with an external pressure source. In this case you will have one solenoid dedicated to increasing the dome pressure and one solenoid dedicated to increasing the dome pressure. The “fill” solenoid’s “1” port should be connected to the pressure source, the “2” port should be connected to the wastegate’s dome, and a plug should be installed in the “3” port. The “vent” solenoid’s “1” port should be connected to the wastegate’s dome, a silencer should be installed in the “2” port (or left open), and a plug should be installed in the “3” port. The bottom chamber of a dual port wastegate always goes to compressor discharge pressure.

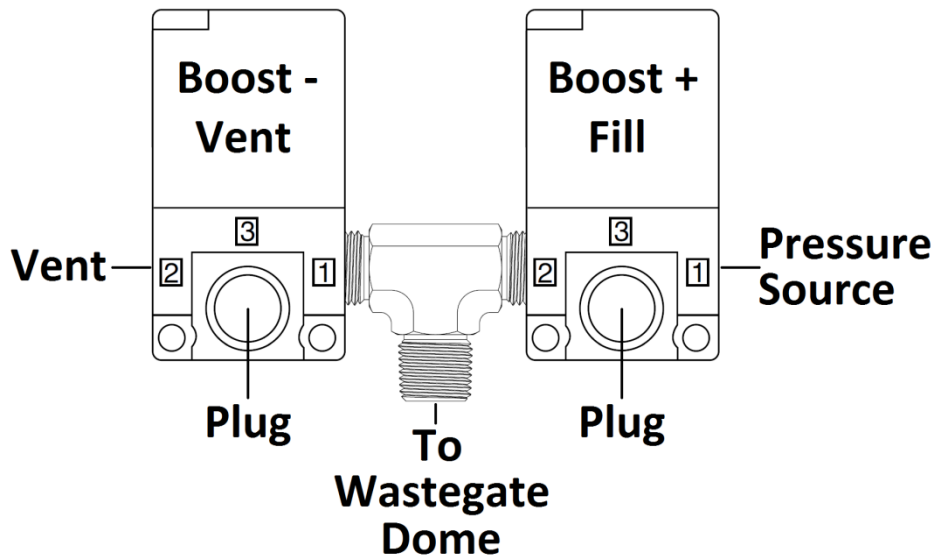

Boost + (Fill) Solenoid

1- Pressure Source

Port 2- Wastegate Dome

Port 3- Plugged

Boost - (Vent) Solenoid

Port 1- Wastegate Dome

Port 2- Vent to atmosphere

Port 3- Plugged

The “Dual Holley” configuration has a number of advantages. Firstly, it can be tuned to have slightly better transient response than a single solenoid. Secondly, it uses less from the pressure source, which is important when using a finite external supply. Thirdly, when used in combination with an external pressure source it can be exercised at any time. This is very useful for the first time setup because you can do some tuning of the PID without even running the engine.

One thing to keep in mind when using a dual solenoid, dual port wastegate configuration is that just disconnecting the solenoids electrically is not the same as running with an open dome. A dual solenoid configuration will trap dome pressure as the wastegate opens resulting in a non-zero dome pressure. If you want to run a true zero dome pressure run, it is best to disconnect the hose to the dome at the wastegate.

5.2.2 Single Solenoid Setup

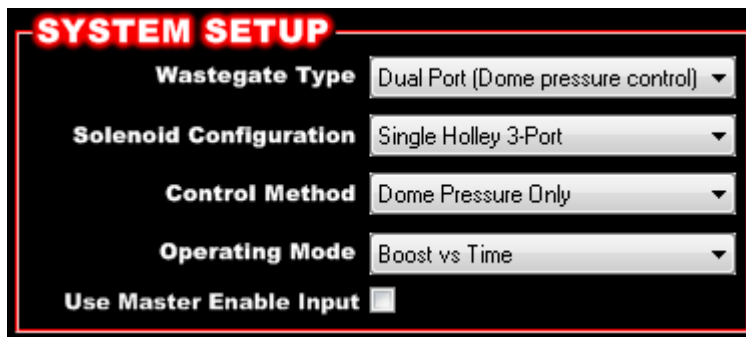

A “Single Holley 3-Port” **Solenoid Configuration** can also be used. The “1” port should be connected to the pressure source, the “2” port should be connected to the wastegate, and a silencer should be installed in the “3” port (or left open). The bottom chamber of a dual port wastegate always goes to compressor discharge pressure.

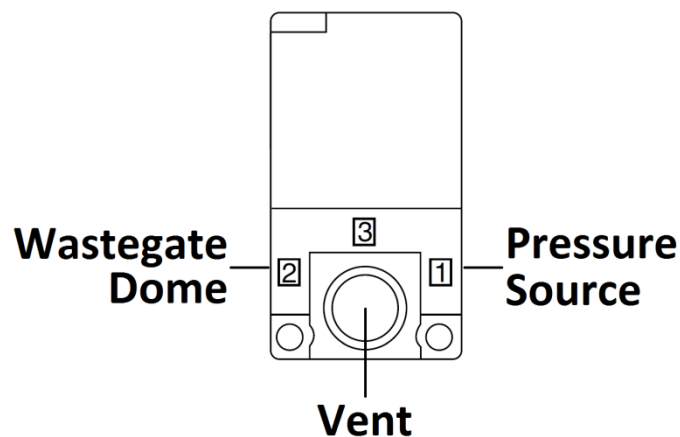

Port 1- Pressure Source

Port 2- Wastegate Dome

Port 3- Vent to atmosphere

Be aware that a single solenoid configuration will consume considerably more from the pressure source when modulating the pressure. If the compressor discharge is used for the pressure source, you cannot tune the PID until you are under boost. In this case, it would be advisable to temporarily plumb the solenoid to an external source for first time tuning without having to run the engine.

5.2.3 Source Pressure Setup

The image shows two configuration screens for a boost control system. The top screen, titled "SOLENOID SOURCE PRESSURE", has a dropdown menu for "Solenoid Source Pressure" set to "Fixed" and a "Fixed Pressure Value" field set to "30.0 PSIG". The bottom screen, titled "CONTROLLER SETUP", has three PID terms: "P Term" at 10.0, "I Term" at 30.0, and "D Term" at 0.0. It also has a "Target Rate Limiter" set to "30.0 psi/sec" and a "Dome Pressure Input" dropdown menu set to "Dome Pressure".

It is important for the ECU to be configured for the correct solenoid pressure source, as it uses the measured or inferred values to establish limits on the final dome pressure target to avoid controller overshoot. If you are using the compressor discharge as a solenoid pressure source without a dedicated sensor, select “Compressor” for the **Solenoid Source Pressure**. In this case the ECU infers this pressure from the MAP sensor. If you have a known pressure source you can select “Fixed” for the **Solenoid Source Pressure** and specify what that pressure is in the **Fixed Pressure Value** field. Probably the most robust way to do it is to use a sensor installed at the source pressure (be it compressor discharge or from a reservoir). In that case you would select “Measured” for the **Solenoid Source Pressure** and specify what pressure sensor is used in the **Source Pressure Input** field. This pressure sensor should be setup in the IO ICF to be visible in the picklist. It is not setup in the **Inputs/Outputs** tab of the Boost ICF.

5.2.4 Dome Pressure Setup

The **Dome Pressure Input** specifies the sensor that measures the dome pressure and is the feedback for the PID controller. This pressure sensor should be setup in the IO ICF to be visible in the picklist. It is not setup in the **Inputs/Outputs** tab of the Boost ICF. Being the fundamental feedback for the “Dome Pressure Only” method, this sensor is very important. Experience has shown that systems can be somewhat sensitive to plumbing. It is advisable to not install the feedback sensor close to the control solenoids since the solenoids generate strong pressure transients. It is best to tap into the wastegate dome at a separate point or install the sensor directly in the wastegate dome. If you only have one port in the wastegate dome, put a tee at this port to so that there is little shared path between the sensor and the solenoids. In cases with excessive wastegate motion, the slight damping from a short remote sensor mount can be of benefit. Again, this sensor should measure the top dome pressure of the wastegate, not the bottom pressure, which should be connected to compressor discharge.

Since the dome pressure sensor is the feedback that is crucial to successful control, it is highly advisable to try to correct for any sensor offset that may be present. For instance you may have a 100psi sensor that reads 0.72psi even at zero pressure. This can cause problems with the boost control if the offset is more than 0.5psi. In this case with a sensor that reads 0.72psi high, the vent solenoid would be on continuously when the dome pressure demand is zero. This is obviously undesirable, but easily remedied. If you have a sensor that reads 0.72psi too high, you can enter -0.72psi in the **Offset** field in the sensor’s configuration screen. If the sensor reads 0.3psi too low, you would enter +0.3psi in the **Offset** field. If you are using an absolute pressure sensor (like a “Holley 3bar”) you must use the *Baro* as the reference point. For example if the sensor reads 104.8kPa while the *Baro* reads 100.8kPa, then the sensor reads 4kPa too high and you need to put in an offset of -4kPa. The reason for this is that all boost and dome pressure measurements are treated as gauge pressures. If you

use an absolute pressure sensor, the barometric pressure measured by the ECU is subtracted out to convert this into a gauge pressure.

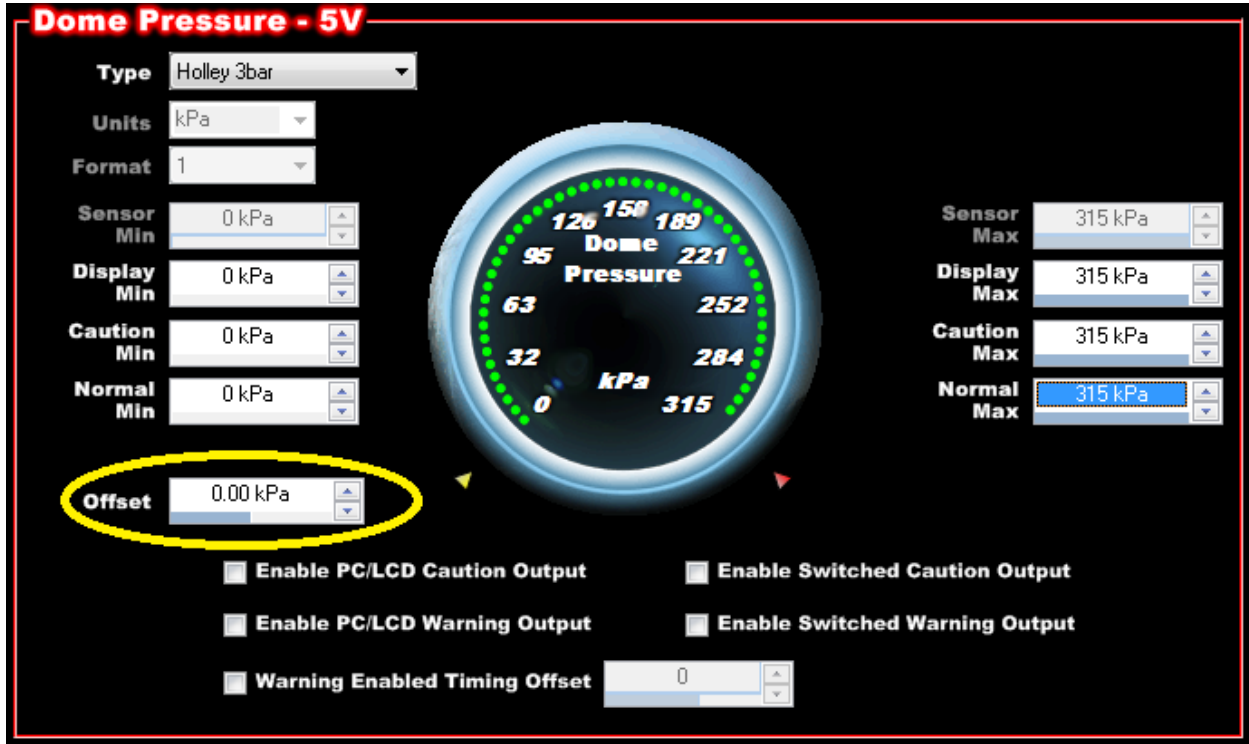

5.2.5 Tuning Notes

Tuning of the dome pressure controller is accomplished through the PID coefficients. The **P Term**, **I Term**, and **D term** jointly determine how the PID controller reacts to error. The controller reacts differently depending on the solenoid configuration since a “leakless” dual solenoid system tends to be inherently integrating whereas a single solenoid system does not. Different systems also have dramatically different gain tolerances depending on the plumbing as well. Combined this makes it somewhat difficult to give good advice as to a baseline gainset. As always, start small and explore the stability boundaries. Back off considerably from gains that allow oscillation and err on the side of stability until you prove it is safe otherwise. More information is given in the PID tuning section. The “Dome Pressure Only” method is somewhat more forgiving to quick overshoots because the turbocharger’s inertia limits the rate at which boost pressure responds to dome pressure. In this respect the physical system can mask some controller errors. In any event tuning that causes large overshoots or oscillation is not acceptable.

The **Target Rate Limiter’s** primary purpose is to contribute to stability and prevent overshoot by limiting the rate of change of the dome pressure target that is the input of the PID controller. Step changes in the target reduce the maximum gains that can be used without significant overshoot, so rate limiting the target allow gains that are slightly more aggressive. To reduce the effect of this rate limiter, set the value to the maximum. Further recommendations for configuring the rate limiter is given in the appendix.

5.2.6 Custom Solenoid Use

It is advised to use Holley solenoids, as a lot of background information will be properly characterized and populated. If you are not using Holley solenoids (or common Humphrey solenoids), you will have to populate the following information. In the event that you specify “Custom” for **Solenoid Configuration**, you need to be aware of the extra calibration parameters that will appear. Not only will the **Solenoid Dead Time** curve and **Solenoid Frequency** field appear in the **Boost Setup** tab, but a **Solenoid Control Signal Table** will appear in the **Dome Control Setup** tab. There is more information about how to determine the right values for a

solenoid's dead time in the appendix. The practical range of the solenoid frequency is bounded by two limits. Too low of a frequency can cause excessive wastegate motion and in extreme cases the turbo will start to respond to the cyclical pressure changes in the pneumatic circuit. Too high of a frequency will cause the solenoid's deadtime to consume a significant fraction of the period and suffers more from the non-linear effects of the pulses running together. 30-40Hz seems to be an acceptable compromise for many solenoids.

If your solenoid(s) are such that it takes a non-zero duty cycle to maintain a steady pressure, you might benefit from utilizing the **Solenoid Control Signal Table**. This purpose of this map is to convert a target output pressure into the needed solenoid duty cycle. This establishes an "open loop" duty cycle based on the pressure demand and the source pressure. More precisely based on the source pressure and the ratio of the pressure demand (gauge) and the solenoid source pressure (gauge) converted to a percent. The logic behind it is this: a three port solenoid behaves much like a pressure divider at any given duty cycle, so the gauge pressure ratio is a convenient way to normalize the output. The source pressure has a slight impact on shape of the post-normalized curve, so the curve can be defined as a function of that pressure. Practically speaking this means that for the source pressure support points of interest you need to sweep solenoid through the duty cycle and develop the demand/source gauge pressure ratio vs. duty cycle curves. Another option is to use Holley solenoids so you don't have to worry about the calibration. The ECU takes the target pressure, divides it by the source pressure to get the ratio, then uses the ratio and the source pressure as inputs to this table to determine what the base duty cycle should be.

Below the main **Solenoid Control Signal Table** are two curves that help you visualize the shape of the values in the table. Sometimes it is difficult to visualize the table data when you are just looking at numbers and 3D graphs can sometimes gloss over important discontinuities. The idea is to take a complex surface and "slices" it at right angles so that you can look at two curves one at a time. In other words instead of trying to view Z vs. X and Y for all of the data at once, you can look at Z vs. X and Z vs. Y at the highlighted point. When you move the highlighted point the "slices" are at different rows and columns. The one on the lower left represents the needed duty cycle to keep a constant output/source pressure ratio as a function of input pressure. The Holley solenoids are relatively robust to the normal range of input pressures, so this is pretty flat and the whole table could almost be reduced to a single curve. However some solenoids behave considerably differently when source pressure is varied, so we have structured the software to be able to let you try to take this into account. The curve on the lower right represents the needed duty cycle to hit the target output/source pressure ratio for a constant source pressure. This is the "meat" of the transformation between desired output pressure to needed duty cycle.

CUSTOM SOLENOID SETUP

Solenoid Dead Time (msec)

9.32	7.25	5.46	4.20	3.49	3.08	2.74	2.43	2.15	1.90	1.67	1.49	1.34	1.22	1.12	1.03
8.0 V	8.8 V	9.6 V	10.4 V	11.2 V	12.0 V	12.8 V	13.6 V	14.4 V	15.2 V	16.0 V	16.8 V	17.6 V	18.4 V	19.2 V	20.0 V

Solenoid Frequency

SOLENOID CONTROL SIGNAL TABLE

Duty Cycle [%]

Demand/Source Ratio [%]	100.0	0.0	0.0	0.0	0.0	0.0	0.0	0.0	0.0	0.0	0.0	0.0	0.0	0.0	0.0	0.0
	99.0	7.5	7.5	7.5	7.6	7.6	7.6	8.2	8.4	8.1	8.1	8.1	8.1	8.1	8.1	8.1
	96.0	13.1	13.1	13.1	13.8	13.0	13.9	14.2	14.3	14.0	14.0	14.0	14.0	14.0	14.0	14.0
	92.0	18.7	18.7	18.7	19.6	19.0	19.8	20.3	20.1	19.8	19.8	19.8	19.8	19.8	19.8	19.8
	87.0	24.0	24.0	24.0	24.8	24.5	25.0	25.6	25.1	25.0	25.0	25.0	25.0	25.0	25.0	25.0
	80.0	29.9	29.9	29.8	30.8	30.2	30.9	31.2	31.0	31.1	31.1	31.1	31.1	31.1	31.1	31.1
	70.0	37.0	37.0	36.9	37.5	37.4	38.1	38.5	38.5	38.3	38.3	38.3	38.3	38.3	38.3	38.3
	58.0	44.2	44.2	44.2	44.7	44.9	45.7	46.6	46.3	46.0	46.0	46.0	46.0	46.0	46.0	46.0
	42.0	53.1	53.1	53.3	54.0	54.4	55.4	56.2	55.4	55.1	55.1	55.1	55.1	55.1	55.1	55.1
	30.0	59.9	59.9	60.2	61.3	61.7	62.5	63.4	62.7	62.0	62.0	62.0	62.0	62.0	62.0	62.0
	20.0	65.9	65.9	66.4	68.0	68.3	69.0	69.8	69.3	68.3	68.3	68.3	68.3	68.3	68.3	68.3
	13.0	70.9	70.9	72.2	73.5	73.6	74.3	74.9	74.2	73.3	73.3	73.3	73.3	73.3	73.3	73.3
	8.0	75.8	75.8	75.9	78.2	78.1	78.9	79.1	78.2	77.6	77.6	77.6	77.6	77.6	77.6	77.6
	4.0	81.2	81.2	81.0	83.4	82.9	83.7	83.7	82.5	81.6	81.6	81.6	81.6	81.6	81.6	81.6
	1.0	90.0	90.0	87.8	89.1	88.0	88.5	88.0	85.7	85.1	85.1	85.1	85.1	85.1	85.1	85.1
	0.0	100.0	100.0	100.0	100.0	100.0	100.0	100.0	100.0	100.0	100.0	100.0	100.0	100.0	100.0	100.0
	0.0	7.6	12.7	17.2	22.0	27.3	37.3	47.1	57.8	57.9	58.0	58.1	58.2	58.3	58.4	58.5

Source Pressure [PSIG]

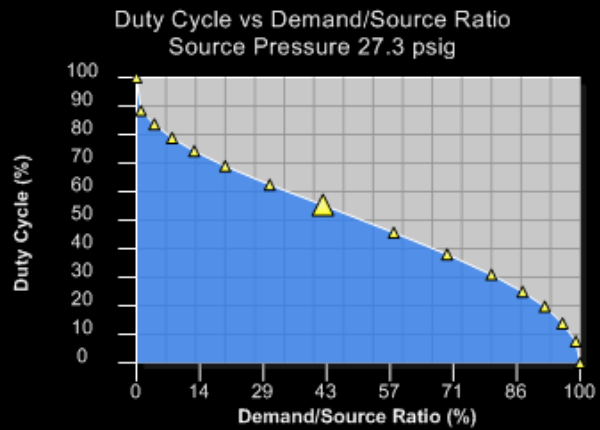
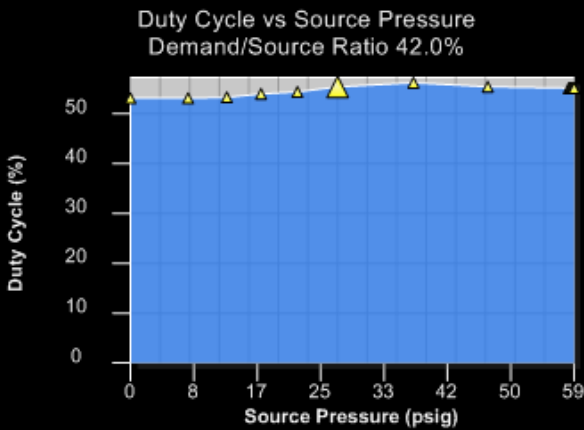

Running “Dome Pressure Only” also becomes riskier if your system has significantly different boost vs. dome pressure curves at different engine speeds. Be aware that using an **Operating Mode** like “Boost vs. Time” opens the door for getting out of sync with your normal run in the event you have hiccups along the way. For instance, assume that at 3.8s you would normally be at 6500RPM and 10psig of dome pressure. If for some reason you are at 4000RPM at 3.8s because of an early setback, the “normal” 10psig of dome pressure could result in an unexpected boost at that engine speed.

Boost Control
 Dual Port Wastegate- Single Solenoid
 Manifold Pressure Control: Not Used
 Dome Pressure Control: OL+CL
 High consumption from pressure source- a disadvantage if using CO2.

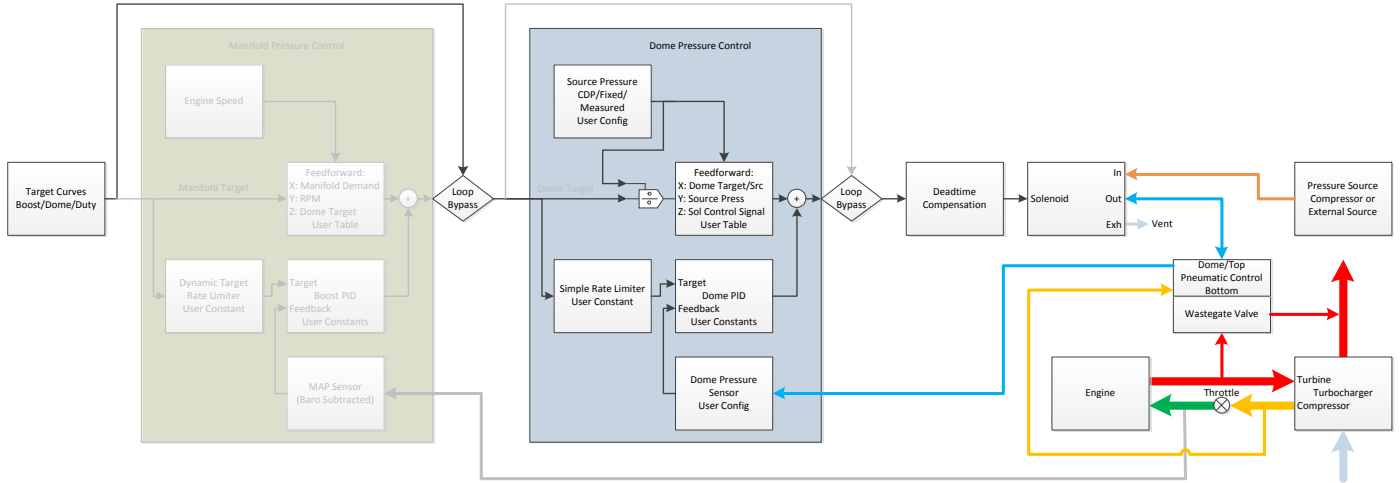

This is a diagram of the system with a dual port wastegate with a single three port solenoid. The dome pressure control section is used and the MAP control loop is bypassed.

Boost Control
 Dual Port Wastegate- 2 Solenoids
 Manifold Pressure Control: Not Used
 Dome Pressure Control: CL
 Does use two solenoids, but lower consumption for CO2 sources.

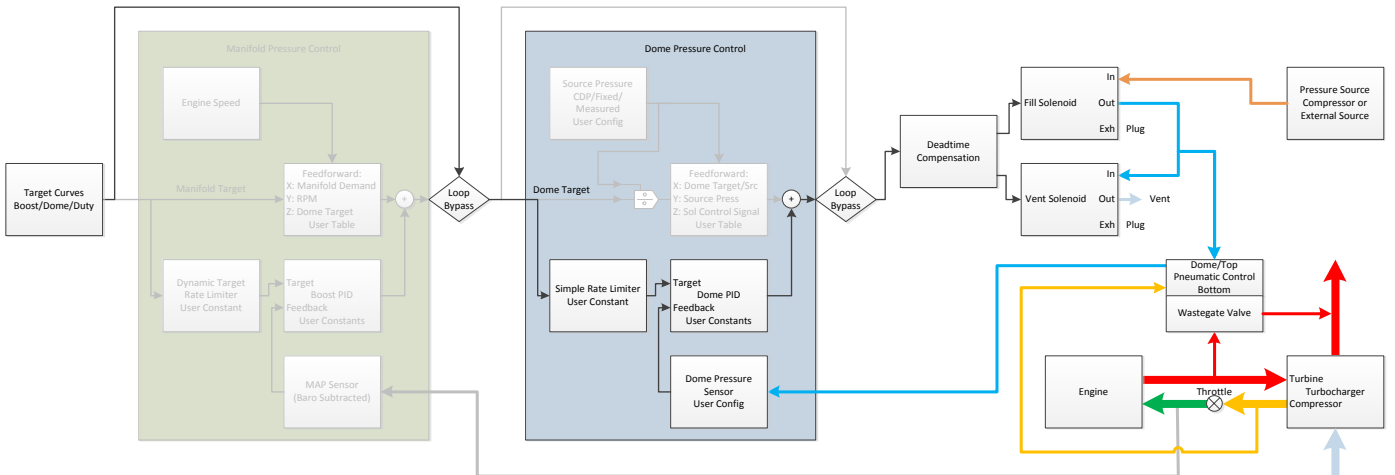

This is a diagram of the system with a dual port wastegate with a two solenoids. The dome pressure control section is used and the MAP control loop is bypassed.

5.3 APPLICATION OF A DUAL PORT WASTEGATE WITH A “MAP AND DOME PRESSURE” CONTROL METHOD

With the “MAP and Dome Pressure” method, there are actually two cascaded controllers that are active simultaneously- one within the other. This same sort of thing used in other places as well. For instance doing idle speed control with a DBW throttle body. The idle speed control is the outer loop whose output goes into determining the input for an inner loop- the target for the DBW position controller. Another example of this

concept is having a PID controller doing “closed loop” fuel control outside of an oxygen sensor controller that tries to maintain Nernst cell voltage with via a pump cell current. In all cases, the success of the outer loop depends on the success of the inner loop. For the “MAP and Dome Pressure” method, you specify all of your targets in terms of actual manifold boost pressure. The outer loop that controls manifold pressure is outside of the inner loop that controls dome pressure. Because of this, you should understand and apply dome pressure control first. It is the cornerstone upon which the “MAP and Dome Pressure” method is built. Both the open loop part and the PID controller of the dome pressure control are active when the “MAP and Dome Pressure” method is used, you just add another layer when you start using the “MAP and Dome Pressure” method. All of the solenoid configurations and plumbing applicable to “Dome Pressure Only” are the same with “MAP and Dome Pressure” method.

The outer loop of the “MAP and Dome Pressure” method also has an open loop part (the **Base Dome Pressure Table**) and a PID controller, which are additive.

5.3.1 *Base Dome Pressure Table*

Just as in the case with the “Dome Pressure Only” method, you have to become familiar with your engine’s boost vs. dome pressure relationship. The difference is that instead of keeping track of the relationship on your own, you simply put this information into the **Base Dome Pressure Table**. In fact, you can use the “MAP and Dome Pressure” method just for this reason and not even use the PID. In that case, you get the benefits of setting all of your boost curves in terms of actual boost pressure instead of dome pressure. By being able to express the boost vs. dome pressure relationship as a function of engine speed, you also remove some of the risk of getting “out of sync” with a normal run if you are using an operating mode that is not “Boost vs. RPM.”

Cementing the **Base Dome Pressure Table** is the first step in tuning the manifold pressure control loop. It is just like the fuel control- the better the base fuel map, the better the “closed loop” functionality works and the less it has to correct. Unlike the fuel control, because of the risk involved there is no learn. This table will not learn itself: you are responsible for it. Fortunately, it really only takes a few runs to get this table close.

We have used the following methodology successfully with our development vehicles.

Firstly, run the vehicle for a while using the “Dome Pressure Only” method. Get comfortable with it, make sure it is stable and hitting the target, and collect data along the way. The more data you take advantage of data you already have, the less you’ll have to run.

Secondly, if you don’t have enough data to make the relationship clear record a few runs with constant dome pressure settings. In other words, record a run with 0 psig dome pressure, then at 2.5 psig, then at 5 psig, etc. depending on your range and available time. You can do this in “Dome Pressure Only” mode or you can switch to the “Manifold Pressure” method and zero the **P Term**, **I Term**, and **D Term** of the manifold pressure controller. In the latter case, you can set the entire table to your target for the run.

Thirdly, start plotting boost vs. measured dome pressure (not dome pressure demand) for different engine speeds. You can use MATLAB, excel, or paper and pencil to do this. There is no shame in graph paper. The shame is in not doing your homework and making bad guesses when you have good data.

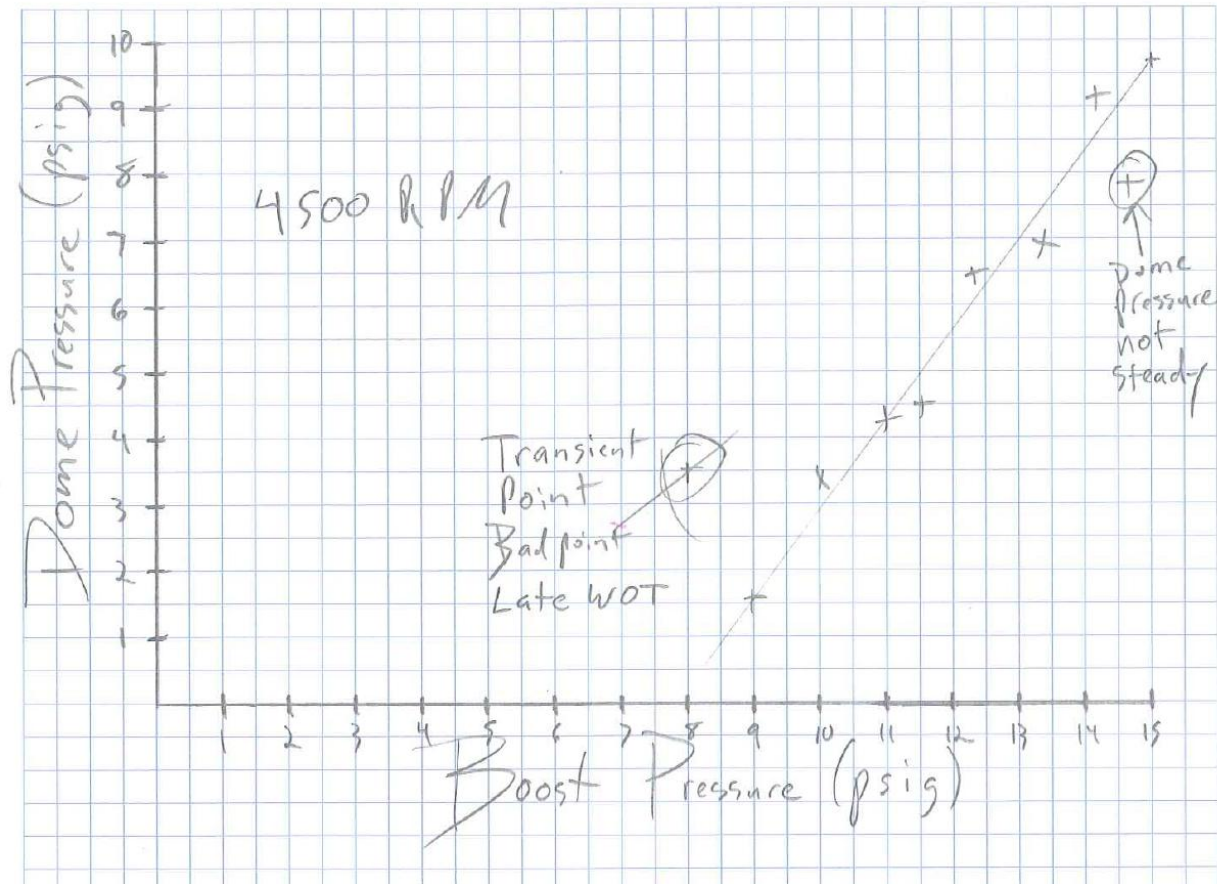

Keep in mind that you interested in the data when the wastegate has stabilized. You will find that it doesn't make any sense to plot the datapoints when the system is not close to equilibrium. At lower engine speeds as the turbo is coming up to speed wastegate hasn't opened yet, so the system will not respond appropriately to changes in control pressure. Rapid changes in boost level, dome pressure, or turbo speed are indicators that the system is not in equilibrium. Energy is being pumped into changing the speed of the turbo therefore the wastegate will reach a different equilibrium during a system transient. This is why the best data to use in the dome pressure vs. boost pressure plots and correlations comes from smooth accelerations in high gears with relatively constant dome pressures during the run. The smoother things are operating, the less the transient effects influence the data. At low speeds before the turbo "wakes up" you can have 100 psig on the dome and only 5 psig of boost, but chances are that this is not a valid data point because the mechanical control system (the wastegate) is not actually in control being that things have not reached equilibrium. You can tell by the shape of the curve when you transition from transient spool up to leveling off into regulation. You can see in the graphic below three distinct phases of wastegate activity. This is a run with no solenoids connected to the dome so it captures the behavior of the wastegate by itself. At low engine speeds, the turbo is spooling up slowly and the wastegate is completely closed. As the boost increases (light green line) there is a transitional period where the wastegate is venting some exhaust, but not enough to actually regulate the boost pressure. At some point, the boost pressure starts to converge toward steady state equilibrium.

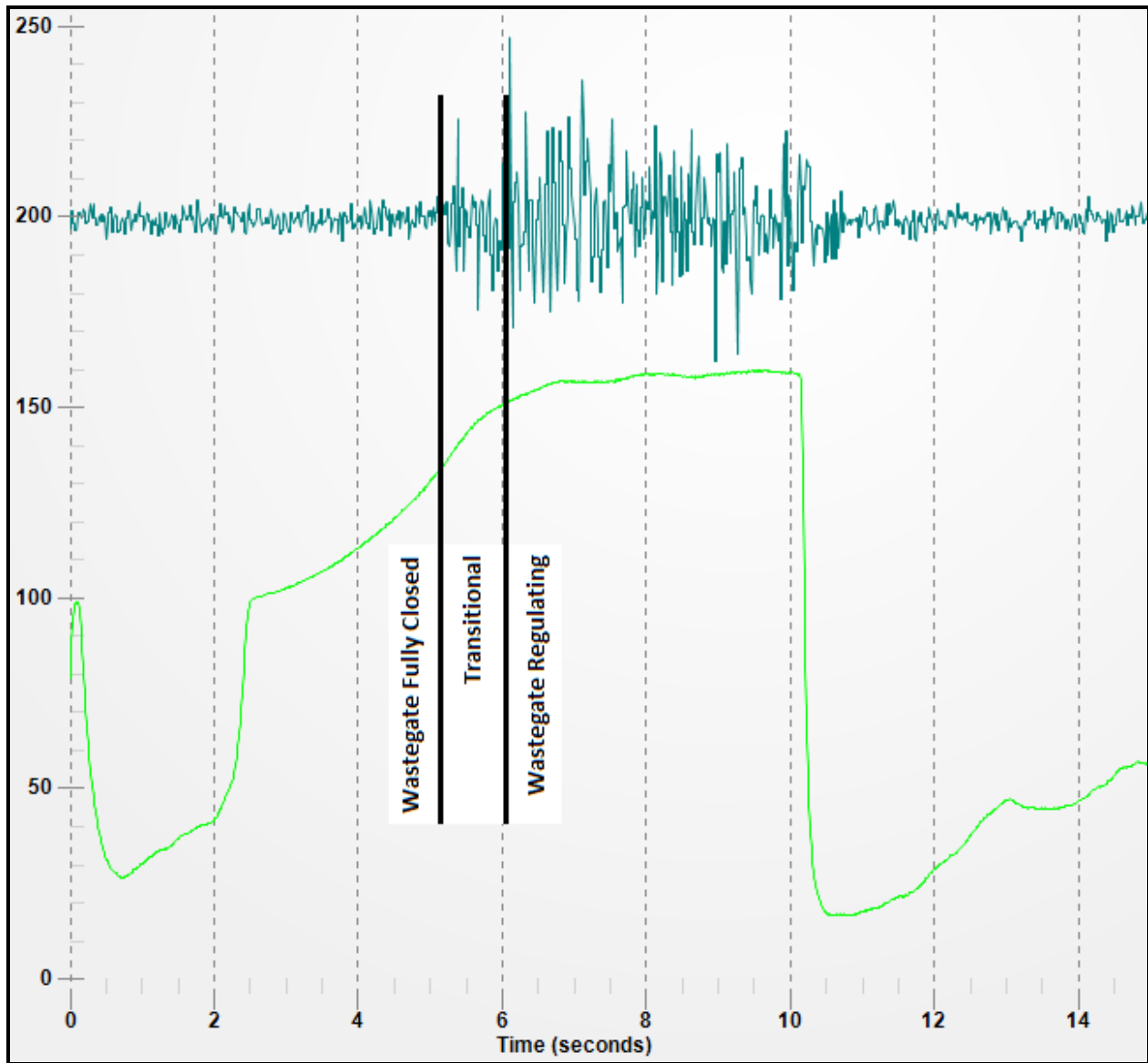

Another giveaway of wastegate activity is an increase in noise on the dome pressure signal due to the physical motion of the valve. In this case, the solenoids were unhooked but the valve motion in conjunction with the restriction of the tubing between the dome and the atmosphere was enough to cause detectable pressure changes in the dome (y-axis values not applicable). This is also why it is important to do final dome pressure PID controller tuning with an engine under boost. As far as the PID is concerned, the wastegate motion is a disturbance. Abrupt changes in engine speed due to shifts also create transients that can introduce deviations from the equilibrium boost vs. dome pressure curves. You just have to look for outliers when you are plotting measure data. With enough data, the trend should become obvious. If your data is noisy sometimes it is helpful to window-average the data over short lengths of time. If after a lot of data collection you see that you have no reliable data for lower engine speeds, this is not abnormal. The good news is that if you do not run there, you don't need data there. You can take the data from the lowest engine speed that looks correct and copy it back to lower engine speeds. Some people choose to use artificially high values at lower engine speeds with the hope that it will accelerate spool up. It can actually help during the transitional region where the wastegate is leaking, but be aware that the only thing the solenoid can do is keep the wastegate closed. If the wastegate is fully closed at 10 psig dome pressure, there is no reason to run 40 psig. It only creates more activity for the dome pressure controller.

Fourthly, start migrating the curves that you have developed to the **Base Dome Pressure Table**. The input to the table is target boost and engine speed, so your points will not line up exactly. Measured data rarely lines up

perfectly with a table's support points. That is why it is important to visualize the shape of one curve at a time so you can interpolate intelligently- whether you fit curves visually or mathematically. It is also good to graph dome pressure vs. engine speed for lines of constant target boost once you assemble your **Base Dome Pressure Table**. This can also help you isolate outlier points. Unlike some other things, this table doesn't have to be a "set and forget." Like the base fuel table, the more you run and the more data and experience you get, the better you can refine the **Base Dome Pressure Table**. At first, the response may seem linear, but you may recognize more nonlinearity once you have higher density measure data.

Below the main **Base Dome Pressure Table** are two curves that help you visualize the shape of the values in the table. Sometimes it is difficult to visualize the table data when you are just looking at numbers and 3D graphs can sometimes gloss over important discontinuities. The idea is to take a complex surface and "slices" it at right angles so that you can look at two curves one at a time. In other words instead of trying to view Z vs. X and Y for all of the data at once, you can look at Z vs. X and Z vs. Y at the highlighted point. When you move the highlighted point the "slices" are at different rows and columns. The one on the lower left represents the needed dome pressure to keep a constant boost as a function of engine speed. The shape of this curve depends on your engine/turbo/wastegate configuration, but it should be relatively smooth. The one on the lower right represents the needed dome pressure to hit the target boost for a constant engine speed. For most applications the one on the right should be reasonably linear with an offset of the x-intercept that represents what the "spring pressure" is for the wastegate. The slope of this line will vary some with engine speed.

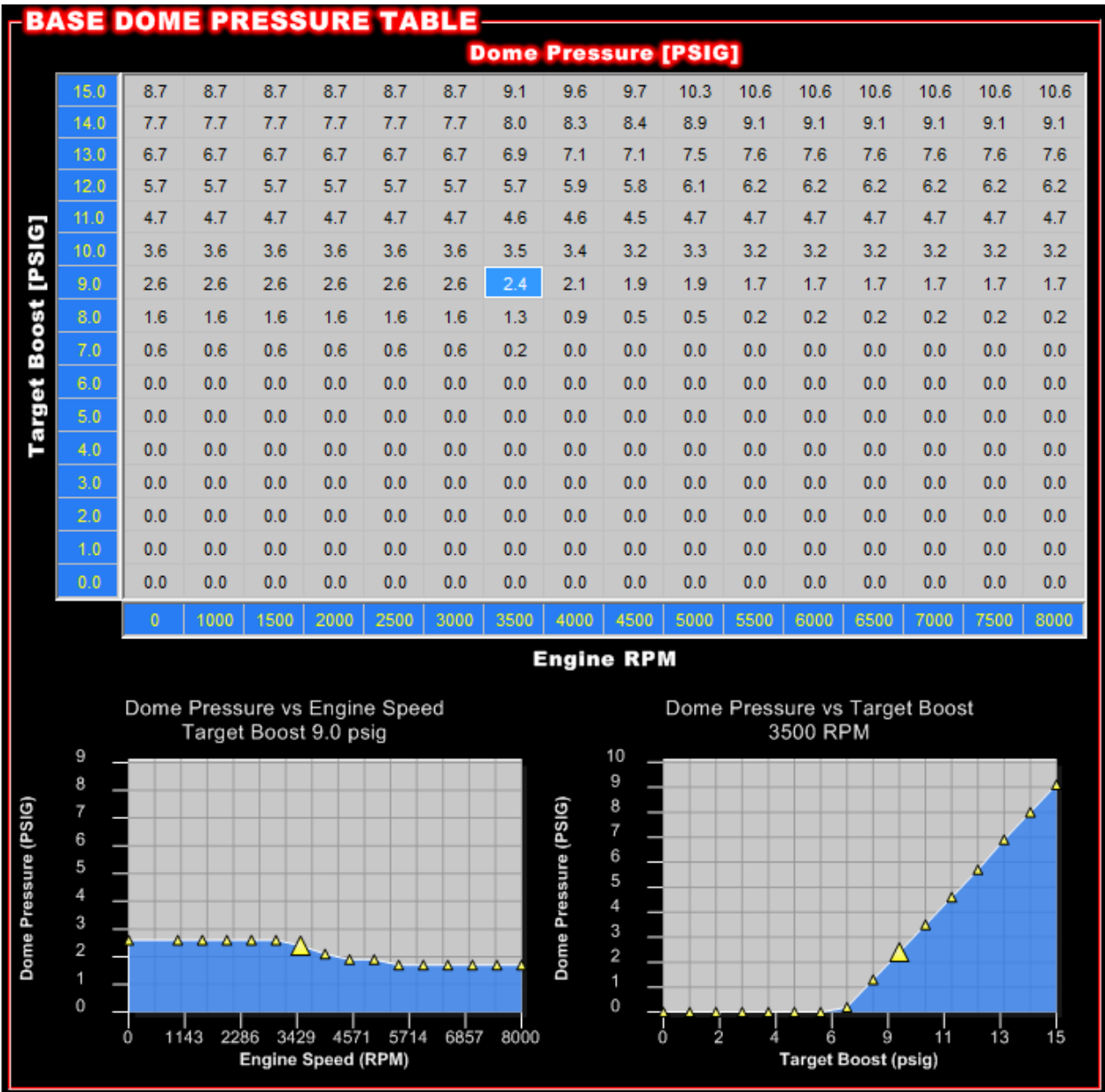

5.3.2 Base Dome Pressure Table PID Control

After you have developed to the **Base Dome Pressure Table** the system should actually follow changes in boost pressure demand and be reasonably close even with zeros for the PID controller gains. This is the point at which it makes sense to utilize the PID functionality if more accuracy is needed.

CONTROLLER SETUP

P Term	<input type="text" value="1.5"/>		Target Rate Limiter	<input type="text" value="8.0 psi/sec"/>
I Term	<input type="text" value="5.0"/>		Activation Threshold	<input type="text" value="5.0 psi"/>
D Term	<input type="text" value="0.2"/>			

The PID controller will only activate when certain conditions are met. Essentially the idea is not to activate the controller until the controller can affect the feedback. Because of this, there is a boost based **Activation Threshold**. This can be set at a value that is close to the “natural” boost of the system when the solenoid is not

active. In other words if the wastegate would not open until 6psig, there is no reason for the PID to be active until you get close to this level. We recommend starting with the wastegate's "spring" pressure. This helps prevent overshoot that can happen when the PID controller is activated too early. Perhaps it goes without saying, but if the **Activation Threshold** is greater than the target boost, chances are the PID will not activate.

The **Target Rate Limiter** is also another tool to control overshoot when boost is building. Even if the wastegate is completely closed the boost will only build at a certain rate because of the turbo system's inertia, therefore it is unreasonable to expect the boost to rise faster than this. The **Target Rate Limiter** establishes how fast the boost target for the PID controller will increase. Since this is specifically to prevent overshoot due to PID windup, the **Target Rate Limiter** is not applied to the boost target for the **Base Dome Pressure Table**. The **Target Rate Limiter** will not limit the rate when boost is below the **Activation Threshold**, but will activate when the boost value reaches this threshold.

The **P Term**, **I Term**, and **D Term** of the manifold pressure controller determines the aggressiveness of the controller. Keep in mind that in an ideal world the **Base Dome Pressure Table** would be close enough that the PID controller does not have to do much. Because of the fact that this is a cascaded control system, there is a limit to how aggressive the outer loop can be without causing instability. Practically this depends on how well the inner loop is working. As always, start small and explore the stability boundaries. Back off considerably from gains that allow oscillation and err on the side of stability until you prove it is safe otherwise. More information is given in the PID tuning section.

Boost Control
 Dual Port Wastegate- Single Solenoid
 Manifold Pressure Control: OL+CL
 Dome Pressure Control: OL+CL
 High consumption from pressure source- a disadvantage if using CO2.

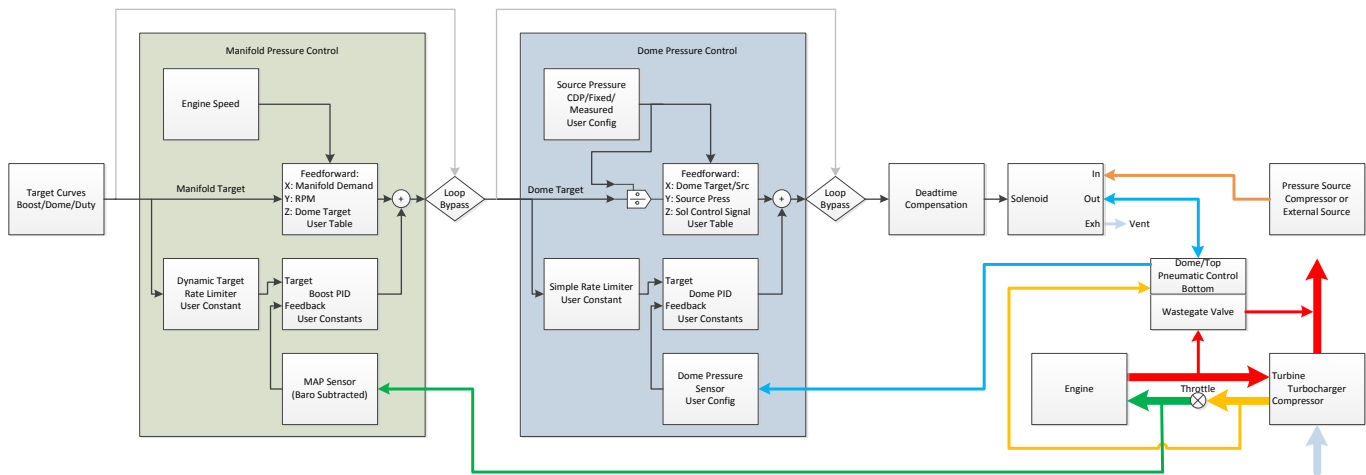

This is a diagram of the system with a dual port wastegate with a single three port solenoid. The MAP control section and dome pressure control section are both used.

Boost Control
Dual Port Wastegate- Two Solenoids
Manifold Pressure Control: OL+CL
Dome Pressure Control: CL

Does use two solenoids, but lower consumption for CO2 sources.

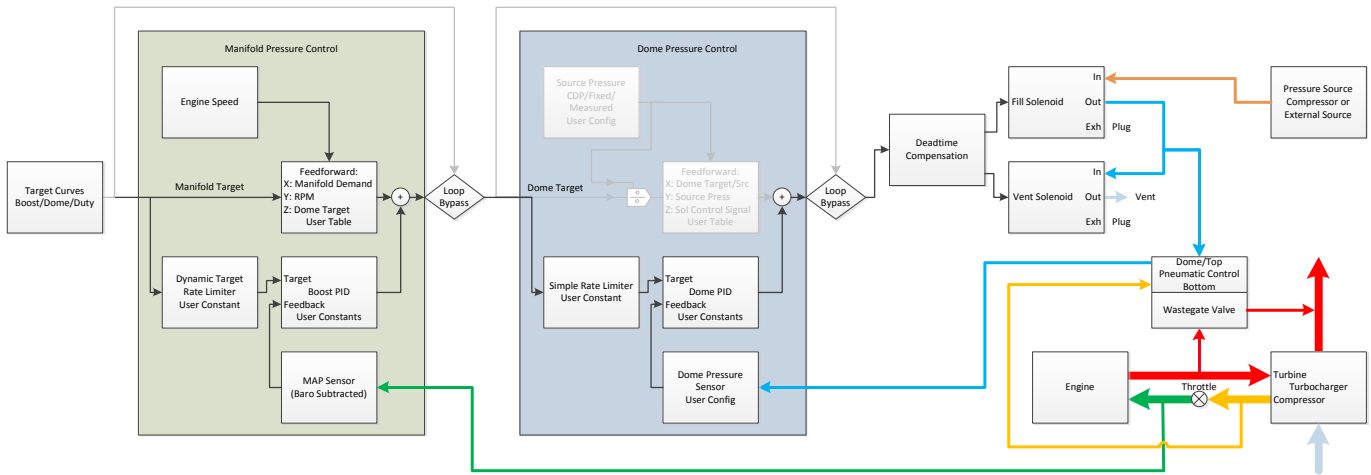

This is a diagram of the system with a dual port wastegate with a two solenoids. The MAP control section and dome pressure control section are both used.

6.0 TARGET CURVES

Everything up to this point has revolved around setting up the system so that it will hit its target. The other piece of the puzzle is the way that you set the target. You have six different ways to be able to establish your base target and they are explained in the sections below.

The target type, units, and range will change depending on the **Control Method**. For instance if you select "Open Loop - Duty Cycle" the target curves will be in duty cycle, in units of %, and have a range of 0-100%. If you select "Dome Pressure Only" the target curves will be in dome pressure (not boost pressure), in units of psig, and the range will be established by your dome pressure sensor. If you select "MAP Pressure" or "MAP and Dome Pressure" the target curves will be in boost pressure (not dome pressure), in units of psig, and the range will be established by your MAP sensor (converted to psig). Regardless of the **Control Method** the final output of the target curve(s), inclusive of scramble offset(s), modified by the TPS modulation will show up as *Target Boost* with units of psig in the data monitor and in the datalogs.

Be aware that the native units of all things boost related in the Holley EFI system is psi gauge. That means the pressure relative to atmospheric measured in psi. Boost is manifold pressure relative to the ECU's measurement of barometric pressure. Consequently, if you target the same boost level at different altitudes or weather conditions you will have a different MAP value and a different power output just like a traditional mechanical control system. Baro compensation is up to you.

6.1 BOOST VS. SPEED

This is one of the simplest operating modes that has only one curve. In the Boost Setup tab the **Speed Input for Boost Control** parameter allows you to assign which speed sensor input is used for the input of the **Boost vs. Speed** curve. Obviously the intention of the function would be to use an input that reflects the vehicle speed. If you want to rescale the x-axis support points for this curve, you can do so in **System Parameters, Sensor Scaling/Warnings, Speed** tab. The output of this curve determines the target boost/dome/duty cycle.

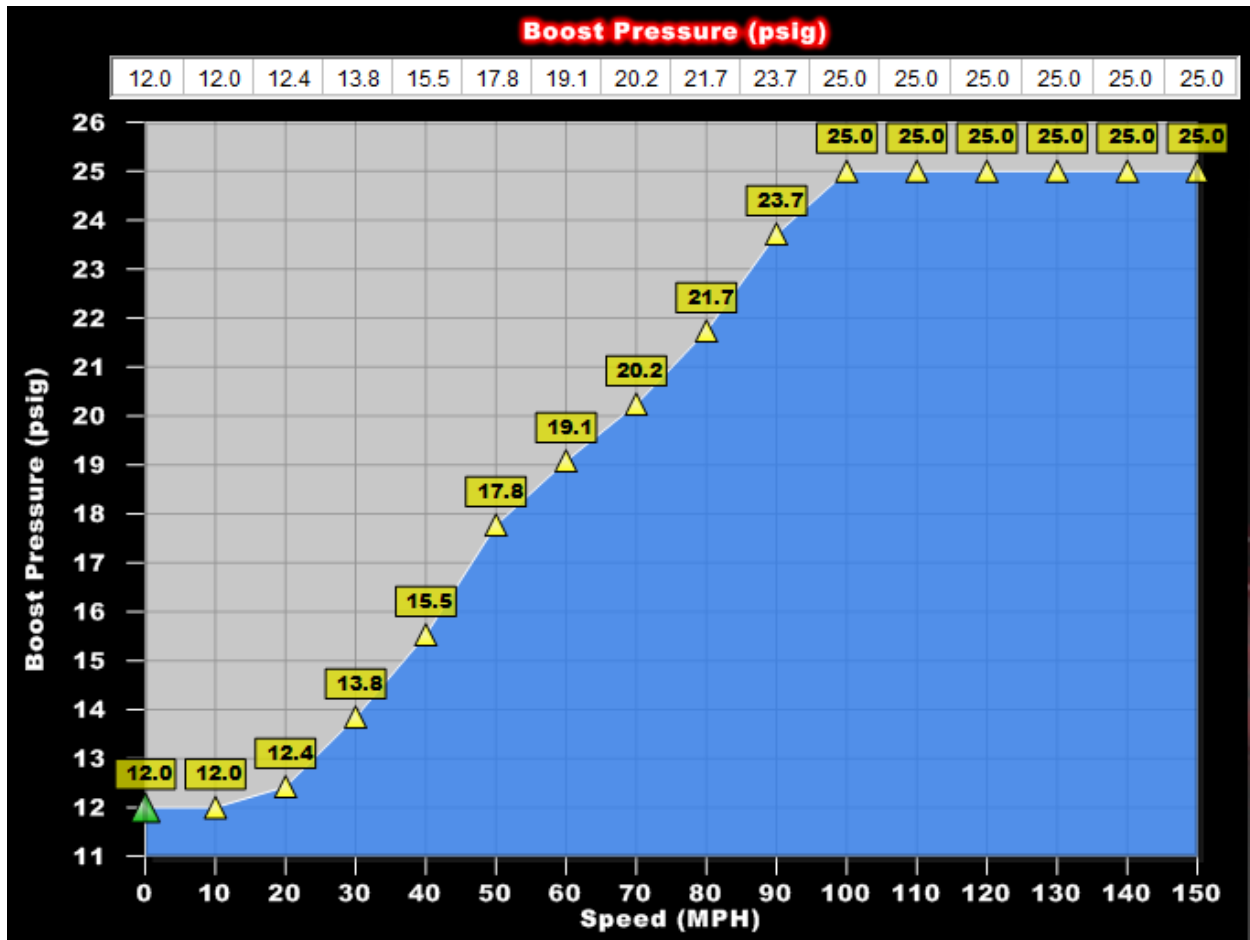

6.2 BOOST VS. TIME

This operating mode also only has one curve. The input of the **Boost vs Time** curve is time since the *T-Brake/Launch* input goes from being active to inactive. Because of that, the *T-Brake/Launch* input is necessary to make this operating mode work correctly. When the *T-Brake/Launch* input is active the timer (*Boost Time*) will be at zero and the target boost/dome/duty cycle will be determined by the value you have in the **Launch Target** field. When the *T-Brake/Launch* input goes inactive the timer (*Boost Time*) will start counting up and the output of this curve determines the target boost/dome/duty cycle. If the timer goes past the value of the last support point, the value of the last point will be held. Because the timer will keep incrementing until the *T-Brake/Launch* input is active and any time beyond the last support point in the **Boost vs Time** curve will “hold” the boost demand of the last point, you might want to consider putting a safe boost value as the last point in the curve. Remember that the x-axis support points do not have to be linearly spaced.

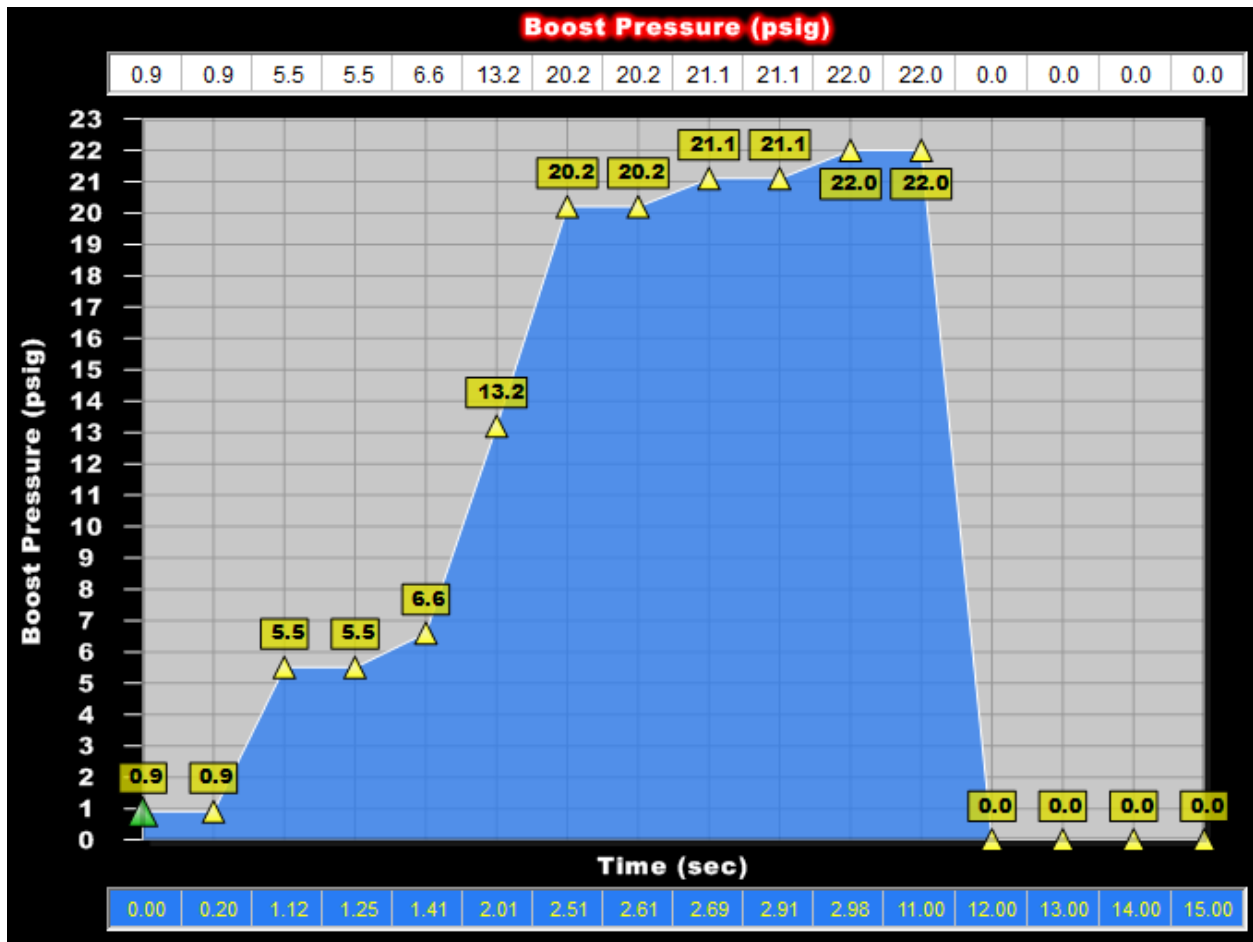

6.3 BOOST VS. GEAR

This operating mode is a bit more complex because there are potentially multiple curves and multiple ways to select which curve is used. The intention is that for each gear you have an independent boost vs. time curve, with the time being the time in that particular gear. There are three ways to select the gear (and therefore applicable curve); using the TCU input if you have an electronically controlled transmission, using an RPM drop to detect a shift and increment the gear, or using a switched input to increment the gear. The gear will be indicated by *Boost Gear* and the time in that gear will be indicated by *Boost Time* in the data monitor and in the datalogs.

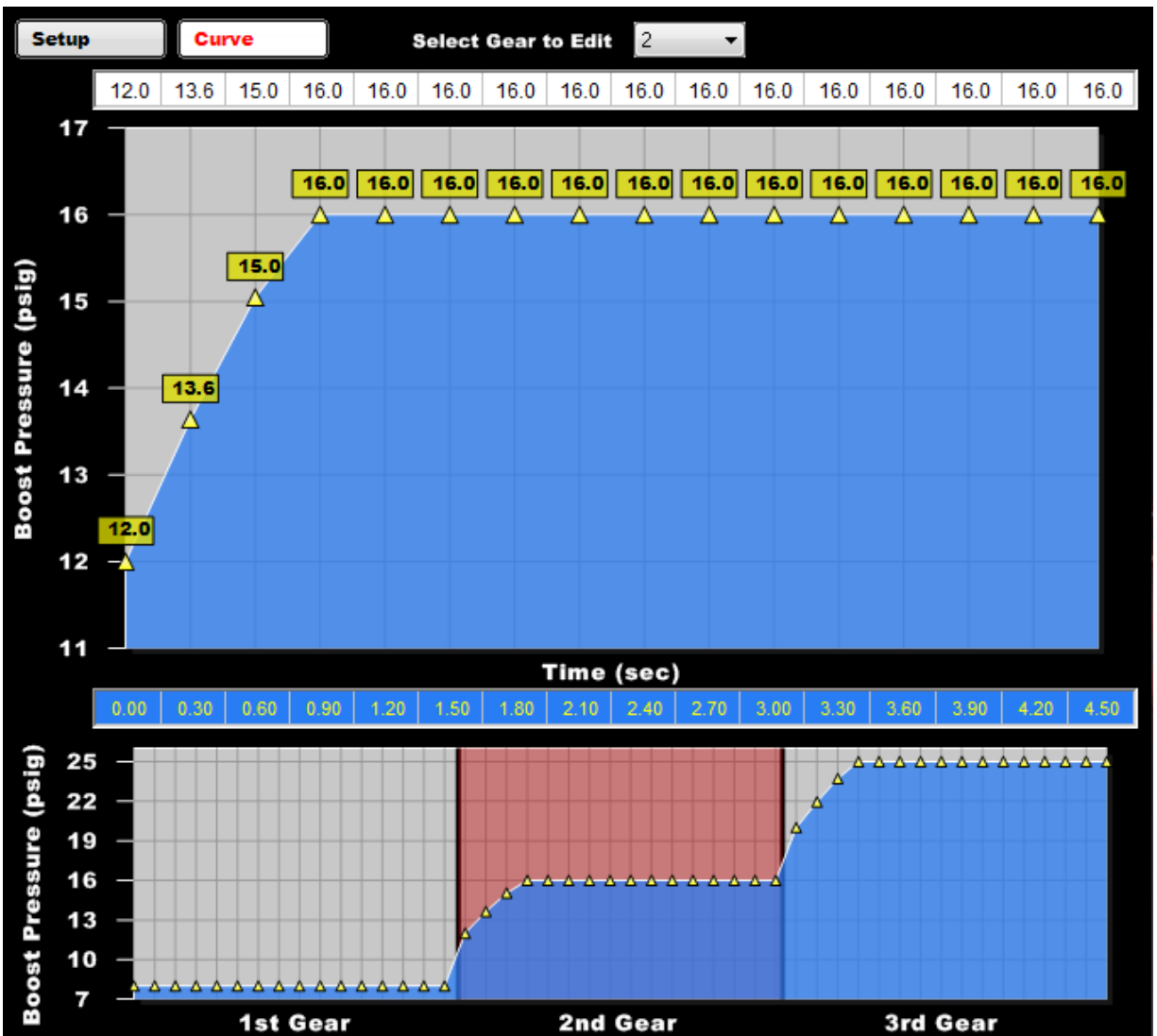

If the "TCU Input" is used, the *Boost Gear* selection is taken care of automatically. The time for first gear will either be relative to the deactivation of the *T-Brake/Launch* input if it is enabled or will start incrementing when the *TPS* goes above **TPS to Start Timer**.

If "RPM Drop" is used, the *Boost Gear* will be estimated by examining the engine speed. If the engine speed drops below the value in **Automatic Gear Reset RPM** for a time greater than **Automatic Gear Reset Time**, the *Boost Gear* will automatically be reset back to 1 and held until you go back above the **Automatic Gear Reset RPM**. If you check the box for **Manual Gear Reset** then asserting the *Manual Reset* input will reset the *Boost Gear* back to 1. The time for first gear will either be relative to the deactivation of the *T-Brake/Launch* input if it is enabled or will start incrementing when the *TPS* goes above **TPS to Start Timer**. If the engine speed goes above **Min RPM for Shift Detect** and then drops by more than **RPM Drop for Shift Detect** the *Boost Gear* variable will be incremented by one until it reaches **Number of Gears**.

SETUP

Number of Gears	3	Automatic Gear Reset RPM	1500 RPM
Shift Recognition	RPM Drop	Automatic Gear Reset Time	3.0 sec
TPS to Start Timer	75%	RPM Drop for Shift Detect	400 RPM
Manual Gear Reset	<input type="checkbox"/>	Min RPM for Shift Detect	3000 RPM

If "Individual Input" is used, the *Boost Gear* will be incremented by active edges of the *Man. Shift Input* until it reaches **Number of Gears**. If the engine speed drops below the value in **Automatic Gear Reset RPM** for a time greater than **Automatic Gear Reset Time**, the *Boost Gear* will automatically be reset back to 1 and held until you go back above the **Automatic Gear Reset RPM**. If you check the box for **Manual Gear Reset** then asserting the *Manual Reset* input will reset the *Boost Gear* back to 1. The time for first gear will either be relative to the deactivation of the *T-Brake/Launch* input if it is enabled or will start incrementing when the *TPS* goes above **TPS to Start Timer**.

6.4 BOOST VS. RPM

This operating mode is very similar to **Boost vs. Gear**. The intention is that for each gear you have an independent boost vs. RPM curve in the event you need to limit boost at low engine speeds because of knock or in low gears because of traction.

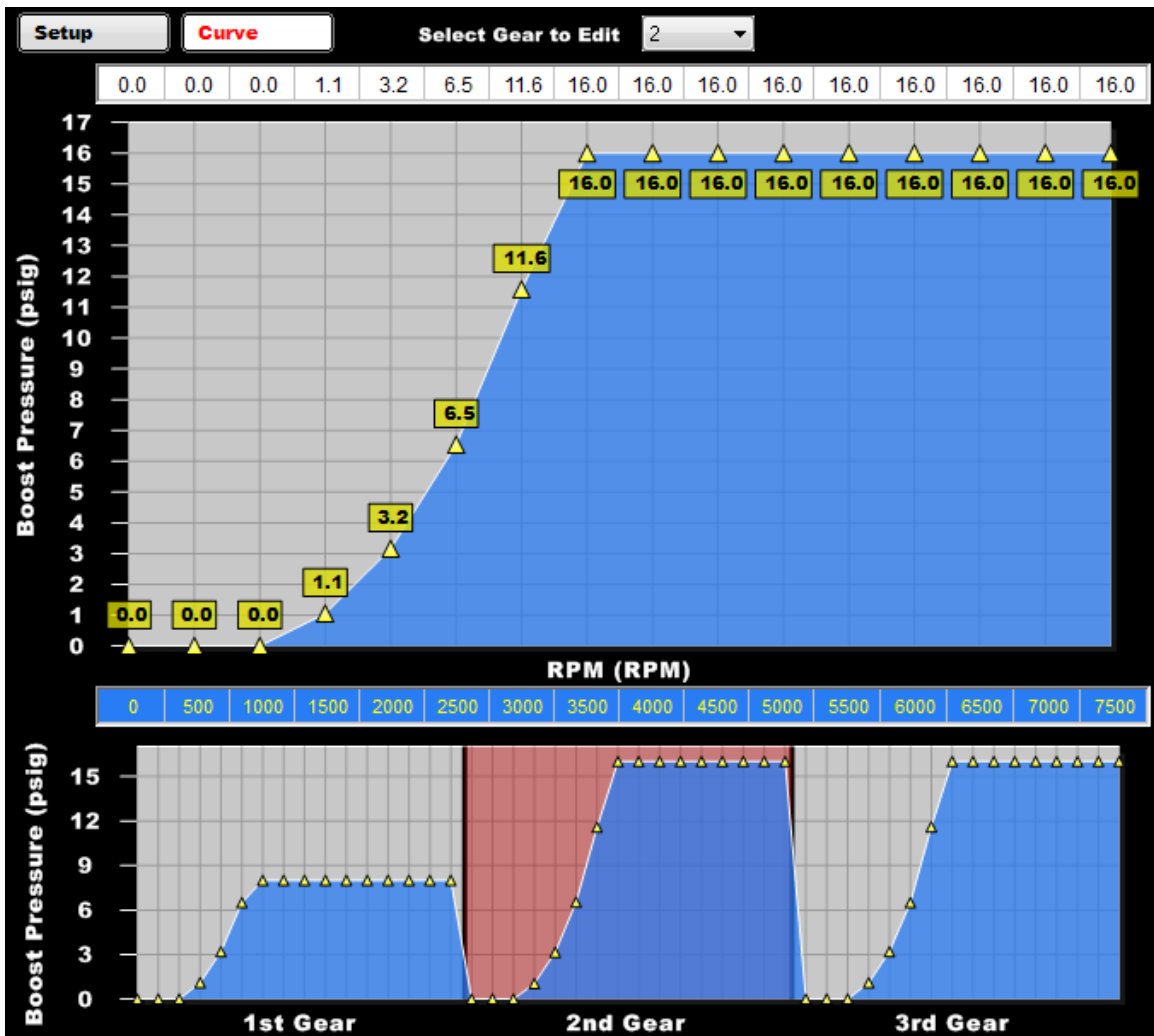

There are three ways to select the gear (and therefore applicable curve); using the TCU input if you have an electronically controlled transmission, using an RPM drop to detect a shift and increment the gear, or using a switched input to increment the gear. The gear will be indicated by *Boost Gear* in the data monitor and in the datalogs.

If the "TCU Input" is used, the *Boost Gear* selection is taken care of automatically.

If “RPM Drop” is used, the *Boost Gear* will be estimated by examining the engine speed. If the engine speed drops below the value in **Automatic Gear Reset RPM** for a time greater than **Automatic Gear Reset Time**, the *Boost Gear* will automatically be reset back to 1 and held until you go back above the **Automatic Gear Reset RPM**. If you check the box for **Manual Gear Reset** then asserting the *Manual Reset* input will reset the *Boost Gear* back to 1. If the engine speed goes above **Min RPM for Shift Detect** and then drops by more than **RPM Drop for Shift Detect** the *Boost Gear* variable will be incremented by one until it reaches **Number of Gears**.

If “Individual Input” is used, the *Boost Gear* will be incremented by active edges of the *Man. Shift Input* until it reaches **Number of Gears**. If the engine speed drops below the value in **Automatic Gear Reset RPM** for a time greater than **Automatic Gear Reset Time**, the *Boost Gear* will automatically be reset back to 1 and held until you go back above the **Automatic Gear Reset RPM**. If you check the box for **Manual Gear Reset** then asserting the *Manual Reset* input will reset the *Boost Gear* back to 1.

6.5 BOOST MANUAL

This operating mode is very similar to **Boost vs. Gear** except for the fact that the stage is only incremented manually. The intention is that for each stage you have an independent boost vs. time curve, with the time being the time in that particular stage. The stage will be indicated by *Boost Stage* and the time in that stage will be indicated by *Boost Time* in the data monitor and in the datalogs.

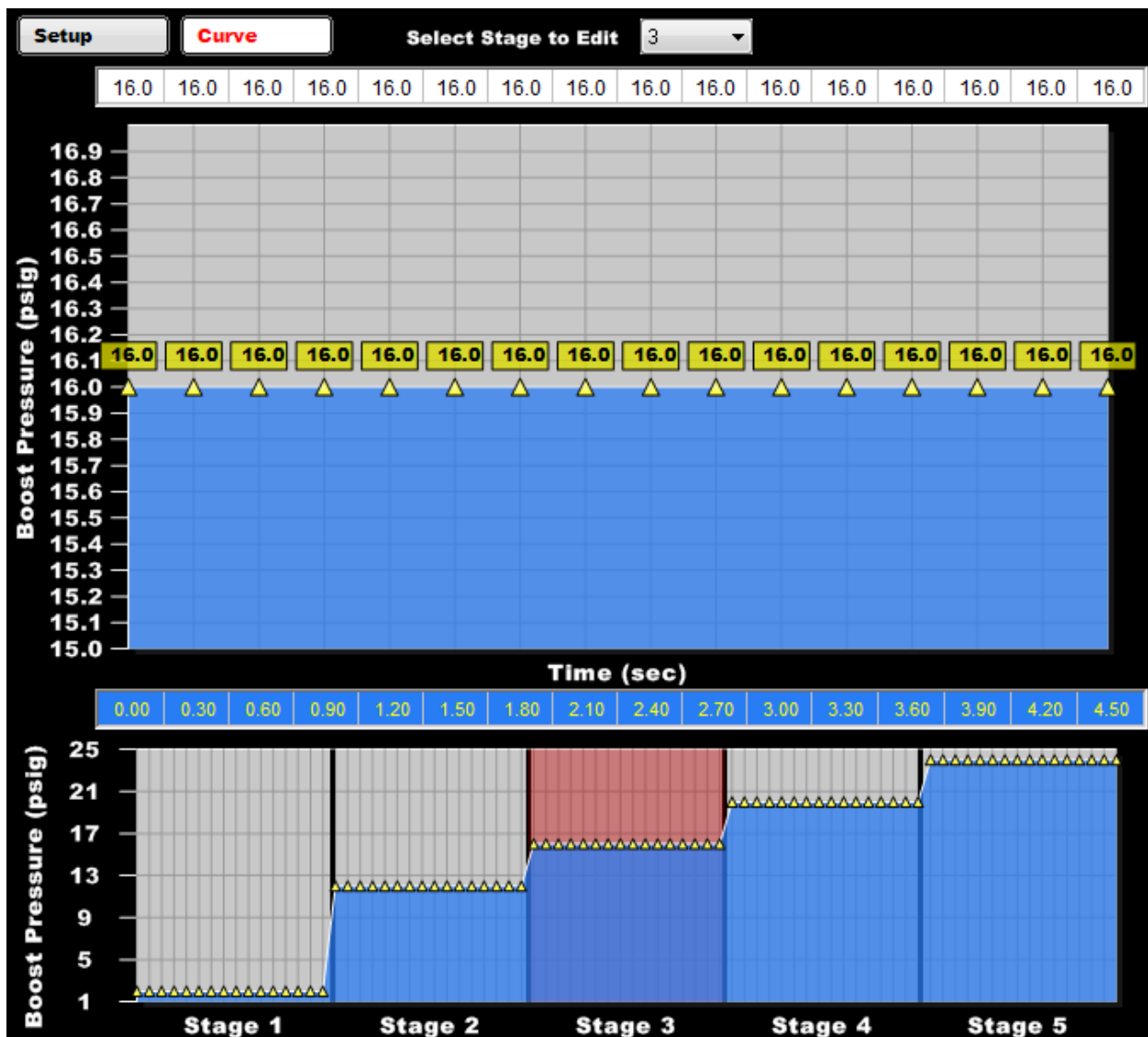

The *Boost Stage* will be incremented by active edges of the *Man. Stage Input* until it reaches **Number of Stages**. If the engine speed drops below the value in **Automatic Gear Reset RPM** for a time greater than **Automatic Gear Reset Time**, the *Boost Stage* will automatically be reset back to 1 and held until you go back above the **Automatic Gear Reset RPM**. If you check the box for **Manual Stage Reset** then asserting the *Manual Reset* input will reset the *Boost Stage* back to 1. The time for the first stage will either be relative to the deactivation of the *T-Brake/Launch* input if it is enabled or will start incrementing when the *TPS* goes above **TPS to Start Timer**.

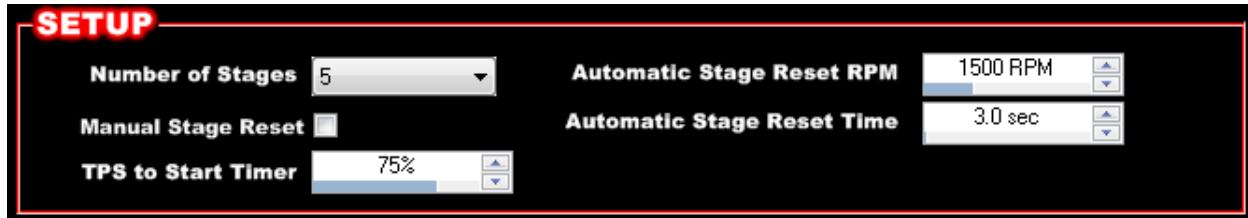

Because the timer will keep incrementing and any time beyond the last support points in the **Boost Manual** curves will “hold” the boost demand of the last point, you might want to consider putting safe boost values as the last points in the curves. Remember that the x-axis support points do not have to be linearly spaced.

6.6 BOOST BUILDER

The boost builder function can be used to try to attain higher levels of boost than the engine/turbo system would build with normal settings. It is important to realize that this is inherently risky because you are intentionally operating the engine badly to make the turbo respond better. You can destroy your engine using this function. The rest of the boost control function revolves around wastegate control, but the boost builder’s usefulness is when the boost is too low for the wastegate to control. If the turbo is fundamentally not being regulated by the wastegate (because the wastegate is completely shut) there is nothing else the boost control function can do.

You can simplify how you think about the system by understanding the turbo needing two things at the same time to “wake up”; massflow and temperature. You can have a relatively high massflow, but without a high temperature going into the turbine the turbo will not “take off.” You can have valve melting temperatures, but with low flow the turbine will make very little power. The flow and temperature have to be high enough for the turbine to be a restriction in the system and build pre-turbine pressure. The turbine derives its power from expanding the gas, and in this case unless there is a pressure drop across the turbine there is no expansion from which to extract the energy. This underscores the difference between energy and exergy (thermodynamic availability) and it confirms what you already know about how the turbo responds at low engine speed. There is an engine speed (flow) below which the turbo will not do much even at WOT. It is the combination of flow and temperature that makes the system “take off” and subsequently need a wastegate in the first place.

The concept of the boost builder function is to do things that will provide better conditions for the turbo (performance wise) immediately before launching. If you are too far away from your critical levels of flow and temperature, the boost builder will not really do that much for you. If you are close it can result in slightly higher boost or in the best case scenario push the system “over the hump” and into normal regulation by the wastegate. It is very easy for instance to increase the pre-turbine temperatures by retarding the timing. You can put the same amount of energy into the cycle but if you do it later there is less expansion (power) stroke left with which to extract the work to the crank, so there is more left over at the end in the form of heat. This is not good for engine efficiency, but it shovels more energy to the turbo.

To use the boost builder function you need to configure five enabling conditions.

Minimum TPS for Activation is the TPS that you have to be above for the boost builder to work.

There is a window of boost defined by two parameters in which the boost builder will work. This is actual boost, regardless of the **Control Method** that is configured. For instance if you are running “Dome Pressure Only” all

of the rest of your targets will be in terms of dome pressure, but in the boost builder the activation window is defined by actual engine boost. As the names imply the boost builder will be active when the boost is between **Minimum Boost for Activation** and **Maximum Boost for Activation**.

There is the option to gate the boost builder function based on the state of the **T-Brake/Launch** input (*Trans Brake*). If you check **Trans Brake/Launch Enabled** option the boost builder function will only activate when the **T-Brake/Launch** input is active.

If you check **Manual Boost Builder Enabled** option the boost builder function will only activate when the **Man. Boost Build** input is active. When **Manual Boost Builder Enabled** enable is checked there will be a **Man. Boost Build** input that shows up in the **Inputs/Outputs** tab. It is here that you select the active state of the input. It will then be available in the PINMAP section to assign to an available input pin.

When the boost builder function is activated it can do combinations of three actions.

When **Fixed Timing** is checked the timing will be completely dictated by the **Fixed Timing** value when the boost builder function is activated. This is not an offset, a trim, or a relative adjustment to any other map, curve, or value. It will not vary as a function of speed or load. It is what you tell it to be- so be careful.

When **Fixed Fuel** is checked the fuel flow will be completely dictated by the **Fixed Fuel** value when the boost builder function is activated. This is not an offset, a trim, or a relative adjustment to any other map, curve, or value. It will not vary as a function of speed or load. It is what you tell it to be- so be careful. Needless to say there will not be a large operating range where this constant fuel flow will be appropriate.

When **Nitrous Activation** is checked the **N2O Boost Builder** output will be activated when the boost builder function is activated. This is completely independent of the other N2O functions and is not influenced by any other setting in the Nitrous ICF. When **Nitrous Activation** enable is checked there will be a **N2O Boost Builder** output that shows up in the **Inputs/Outputs** tab. It is here that you select the active state of the output. There is no progression in the output: it is either on or off. Because of this “PWM+” is functionally identical to “+12V” and “PWM-“ is the same as “GROUND.” It will then be available in the PINMAP section to assign to an available output pin. Note that this pin does not have to control a nitrous solenoid directly. It can be looped back to an enabling input of the nitrous ICF to do more advanced nitrous functions or can be used to control some entirely different device.

7.0 VARIABLES FOR THE BOOST CONTROL FUNCTION

7.1 NORMAL VARIABLES

Boost Gear displays the current gear used to select the target curve in Boost vs. Gear operating mode.

Boost Stage displays the current stage used to select the target curve in Boost Manual operating mode.

Boost always displays actual engine boost, even if the **Control Method** is “Dome Pressure Only” or “Open Loop- Duty Cycle.”

Boost Speed displays the current speed used for the input of the Boost vs. Speed curve.

Boost Time displays the time for the current gear or stage, or time since launch for the first gear/stage.

Target Boost displays the target for the boost control, which comes from the target curves. If the **Control Method** is “MAP and Dome Pressure” or “MAP Pressure” the *Target Boost* will be actual engine boost. If the **Control Method** is “Dome Pressure Only” the *Target Boost* will be dome pressure. If the **Control Method** is “Open Loop- Duty Cycle” the *Target Boost* will be duty cycle.

Trans Brake shows the state of that input. In the data monitor a green dot means that the input is active and grey dot means that the input is not. In a data log 1 is active and 0 is not.

Boost Scramble + shows the state of that input. In the data monitor a green dot means that the input is active and grey dot means that the input is not. In a data log 1 is active and 0 is not.

Boost Scramble – shows the state of that input. In the data monitor a green dot means that the input is active and grey dot means that the input is not. In a data log 1 is active and 0 is not.

Manual Boost Build shows the state of that input. In the data monitor a green dot means that the input is active and grey dot means that the input is not. In a data log 1 is active and 0 is not.

Manual Boost Reset shows the state of that input. In the data monitor a green dot means that the input is active and grey dot means that the input is not. In a data log 1 is active and 0 is not.

Boost Build shows the activation status of the Boost Build function.

Boost Solenoid Duty conveys what the solenoids are doing. In a single solenoid configuration this will range from 0% to 100%. With a dual solenoid system it will range from -100% to 100% where negative numbers mean that the vent solenoid is activating and positive numbers mean the fill solenoid is activating. This duty cycle does not include the voltage compensation so it will not be the electrical duty cycle at the output pin.

Boost Safety communicates the activity of the safety function in a “decade encoded” fashion. This just means that each digit represents something different. Each digit can have three states that indicate the action that is being taken.

0 means the safety is taking no action

1 means the boost control reverts to the lowest possible boost

2 means the ignition and fuel is being cut

The one's digit (rightmost) is for the high boost limit that has no activation time.

The ten's digit (second from right) is for the high boost limit that also has an activation time.

The hundred's digit (third from right) is for the boost error index.

The thousand's digit (fourth from the right) is for the high dome pressure limit that has no activation time.

The ten thousand's digit (fifth from right) is for the high dome pressure limit that also has an activation time.

The hundred thousand's digit (sixth from right) is for the dome pressure error index.

The million's digit (seventh from right) is for the safety linked from a switched output.

Example: *Boost Safety* =1000 means the safety system has reverted low boost because the Dome pressure spiked above your limit. *Boost Safety* =20 means the safety system has cut the ignition because the boost pressure was above your limit for the time you specified.

7.2 INTERNAL VARIABLES

The boost control function has many available options and configurations. Consequently there are more variables than can be listed in the base list, so if you want to view intermediate variables for data logging or

troubleshooting you must take advantage of being able to assign an input to an internal variable. You can make an input and call it what you want, enable it, and select “INTERNAL” as the type. Then in the configuration options choose the variable that you want to be able to see. In this case I wanted to see the output of the **Base Dome Pressure Table** (dual port wastegate with MAP and dome pressure control).

INPUTS					
	NAME	TYPE	ECU PIN	ENABLE	
#1	BaseDomePressure	GROUND	NOT DEFINED	<input checked="" type="checkbox"/> Enable	Configure
#2		+12V	NOT DEFINED	<input type="checkbox"/> Enable	Configure
#3		GROUND	NOT DEFINED	<input type="checkbox"/> Enable	Configure
#4		DIGITAL SPEED	NOT DEFINED	<input type="checkbox"/> Enable	Configure
#5		IPU SPEED	NOT DEFINED	<input type="checkbox"/> Enable	Configure
#6		5 VOLT	NOT DEFINED	<input type="checkbox"/> Enable	Configure
		20 VOLT	NOT DEFINED	<input type="checkbox"/> Enable	Configure
		THERMISTOR	NOT DEFINED	<input type="checkbox"/> Enable	Configure
		CAN 5V	NOT DEFINED	<input type="checkbox"/> Enable	Configure
		INTERNAL	NOT DEFINED	<input type="checkbox"/> Enable	Configure

BaseDomePressure - INTERNAL

Type	Fuel_AE_MapRocDecayTime		
Units	Boost_ManualInput		
Format	Boost_ShiftInput		
Sensor Min	Boost_SafetyRevertToWastegateActive	Sensor Max	2000
Display Min	Boost_SafetyCutIgnitionActive	Display Max	100
Caution Min	Boost_SafetyHighBoost	Caution Max	90
Normal Min	Boost_SafetyHighBoostTimed	Normal Max	80
	Boost_SafetyHighBoostErrorIndex		
	Boost_SafetyHighDome		
	Boost_SafetyHighDomeTimed		
	Boost_SafetyHighDomeErrorIndex		
	Boost_SafetyFromSwitchedOutput		
	Boost_FillSolenoidDutyFinal		
	Boost_VentSolenoidDutyFinal		
	Boost_VoltageCompensation		
	Boost_ManPresDynLimit		
	Boost_ManPresLimitedTarget		
	Boost_ManPresPIDTarget		
	Boost_ManPresBaseTable		
	Boost_ManPresPIDOutput		
	Boost_ManPresBase+PID		
	Boost_ManPresMeasured		
	Boost_ManPresMeasuredRoC		
	Boost_DomePresLimitedTarget		
	Boost_DomePresPIDTarget		
	Boost_DomePresBaseTable		
	Boost_DomePresRawTarget		
	Boost_DomePresPIDOutput		
	Boost_DomePresBase+PID		
	Boost_DomePresMeasured		
	Boost_DomePresMeasuredRoC		

Switched Caution Output

Switched Warning Output

Boost_ManualInput indicates the state of the Man. Stage Input. A value of 1 means that the input is active and a 0 means that the input is not active.

Boost_ShiftInput indicates the state of the Man. Shift Input. A value of 1 means that the input is active and a 0 means that the input is not active.

Boost_SafetyRevertToWastegateActive indicates if any of the boost safety criteria are actively invoking the “revert to wastegate” action.

Boost_SafetyCutIgnitionActive indicates if the boost safety function is cutting the ignition. This is not the same thing as a boost safety condition set being violated because there are other things that would defeat the action.

For instance if engine speed drops below 2500RPM the ignition cut will be removed to keep the engine from dying even though the safety condition might still be violated.

Boost_SafetyHighBoost indicates the action that is being taken because the boost level has peaked above that which is setup in the safety setup. Zero means no action, one means revert to wastegate, and two means cut ignition.

Boost_SafetyHighBoostTimed indicates the action that is being taken because the boost level was too high for longer than that which is setup in the safety setup. Zero means no action, one means revert to wastegate, and two means cut ignition.

Boost_SafetyHighBoostErrorIndex indicates the action that is being taken because the boost error index was too high for longer than that which is setup in the safety setup. Zero means no action, one means revert to wastegate, and two means cut ignition.

Boost_SafetyHighDome indicates the action that is being taken because the dome pressure has peaked above that which is setup in the safety setup. Zero means no action, one means revert to wastegate, and two means cut ignition.

Boost_SafetyHighDomeTimed indicates the action that is being taken because the dome pressure was too high for longer than that which is setup in the safety setup. Zero means no action, one means revert to wastegate, and two means cut ignition.

Boost_SafetyHighDomeErrorIndex indicates the action that is being taken because the dome pressure error index was too high for longer than that which is setup in the safety setup. Zero means no action, one means revert to wastegate, and two means cut ignition.

Boost_SafetyFromSwitchedOutput indicates the action that is being taken because the selected switched output was active for longer than that which is setup in the safety setup. Zero means no action, one means revert to wastegate, and two means cut ignition.

Boost_FillSolenoidDutyFinal includes the voltage compensation so it is the actual duty cycle at the output pin for the solenoid or fill solenoid in a dual solenoid system.

Boost_VentSolenoidDutyFinal includes the voltage compensation so it is the actual duty cycle at the output pin for the vent solenoid in a dual solenoid system. Unlike the *Boost Solenoid Duty* which represents vent solenoid activity in the -100% to 0% range, the range of *Boost_VentSolenoidDutyFinal* is 0-100%.

Boost_VoltageCompensation is the output of the solenoid dead time curve, which is calculated automatically for Holley solenoids.

Boost_ManPresSensorLimit establishes the maximum boost pressure target based on the dome pressure sensor's range. In order to have adequate overhead the maximum MAP target is limited to 90% of the sensor's range.

Boost_ManPresPIDTarget is the target of the PID, which is after any limits based on the MAP sensor range or the dynamic rate limiter. Below the **Activation Threshold** this will be the value specified in the **Activation Threshold**, but the PID will not be activated.

Boost_ManPresBaseTable is the output of the base **Base Dome Pressure Table** for the "MAP and Dome Pressure" **Control Method** or the **Base Duty Cycle Table** for "MAP Pressure" **Control Method**.

Boost_ManPresPIDOutput is the output of the PID controller itself.

Boost_ManPresBase+PID is the combined output of the base table and the PID controller. This is passed along as the target of the dome pressure controller for the “MAP and Dome Pressure” **Control Method**. In the case of “MAP Pressure” **Control Method** this becomes the *Boost Solenoid Duty*.

Boost_ManPresMeasured is the boost calculated from the MAP sensor converted to psig.

Boost_ManPresMeasuredRoC is the rate of change of the MAP sensor output, which is used for calculating the D-part of the PID controller. It is not a pure derivative, but has some filtering applied to reduce noise.

Boost_DomePresSensorLimit establishes the maximum dome pressure target based on the dome pressure sensor’s range. In order to have adequate overhead the maximum dome pressure target is limited to 90% of the sensor’s range.

Boost_DomePresPIDTarget is the target of the PID, which is after any limits based on the dome pressure sensor range, the solenoid source pressure, or the **Target Rate Limiter**.

Boost_DomePresBaseTable is the output of the base **Solenoid Control Signal Table**. For many modes it is normal for it to always be zero.

Boost_DomePresRawTarget is the instantaneous target, which is before any limits based on the dome pressure sensor range, the solenoid source pressure, or the **Target Rate Limiter**.

Boost_DomePresPIDOutput is the output of the PID controller itself.

Boost_DomePresBase+PID is the combined output of the base **Solenoid Control Signal Table** and the PID controller.

Boost_DomePresMeasured is what the dome pressure sensor is measuring. This may seem redundant, but since it is always in psig it can be useful if the sensor’s native reading is kPa abs and you’d rather see psig units.

Boost_DomePresMeasuredRoC is the rate of change of the dome pressure sensor, which is used for calculating the D-part of the PID controller. It is not a pure derivative, but has some filtering applied to reduce noise.

Boost_DomePresSolSource is the pressure at the input of the solenoid. In order to have adequate overhead the maximum dome pressure target is limited to 90% of the pressure available pressure at the solenoid.

Boost_BuilderFixedTimingActive indicates if the boost builder function is dictating the timing. A value of 1 means that the boost builder timing override is active and a 0 means that the timing is normal.

Boost_BuilderFixedFuelActive indicates if the boost builder function is dictating the fuel flow. A value of 1 means that the boost builder fuel flow override is active and a 0 means that the fueling is normal.

Boost_BuilderNitrousActive indicates if the boost builder function is activating the **N2O Boost Builder** output. A value of 1 means that the output is active and a 0 means that it is not.

8.0 APPENDIX

8.1 LAYOUT OF A TYPICAL DUAL PORT WASTEGATE, TWIN SOLENOID SYSTEM

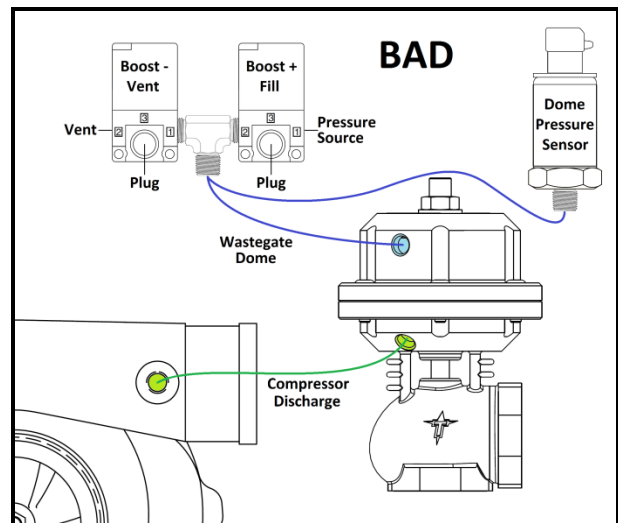
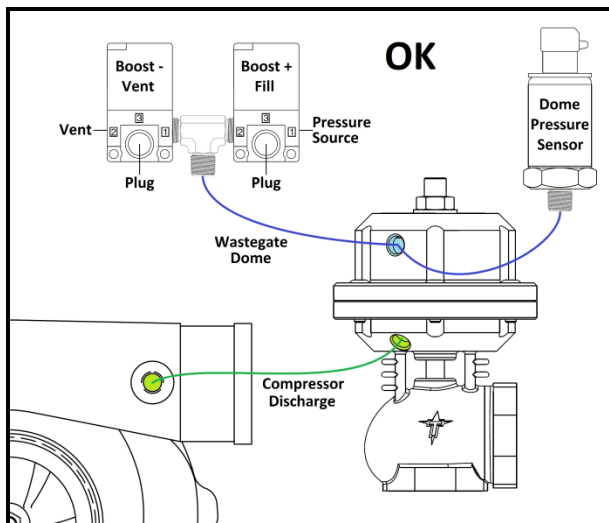
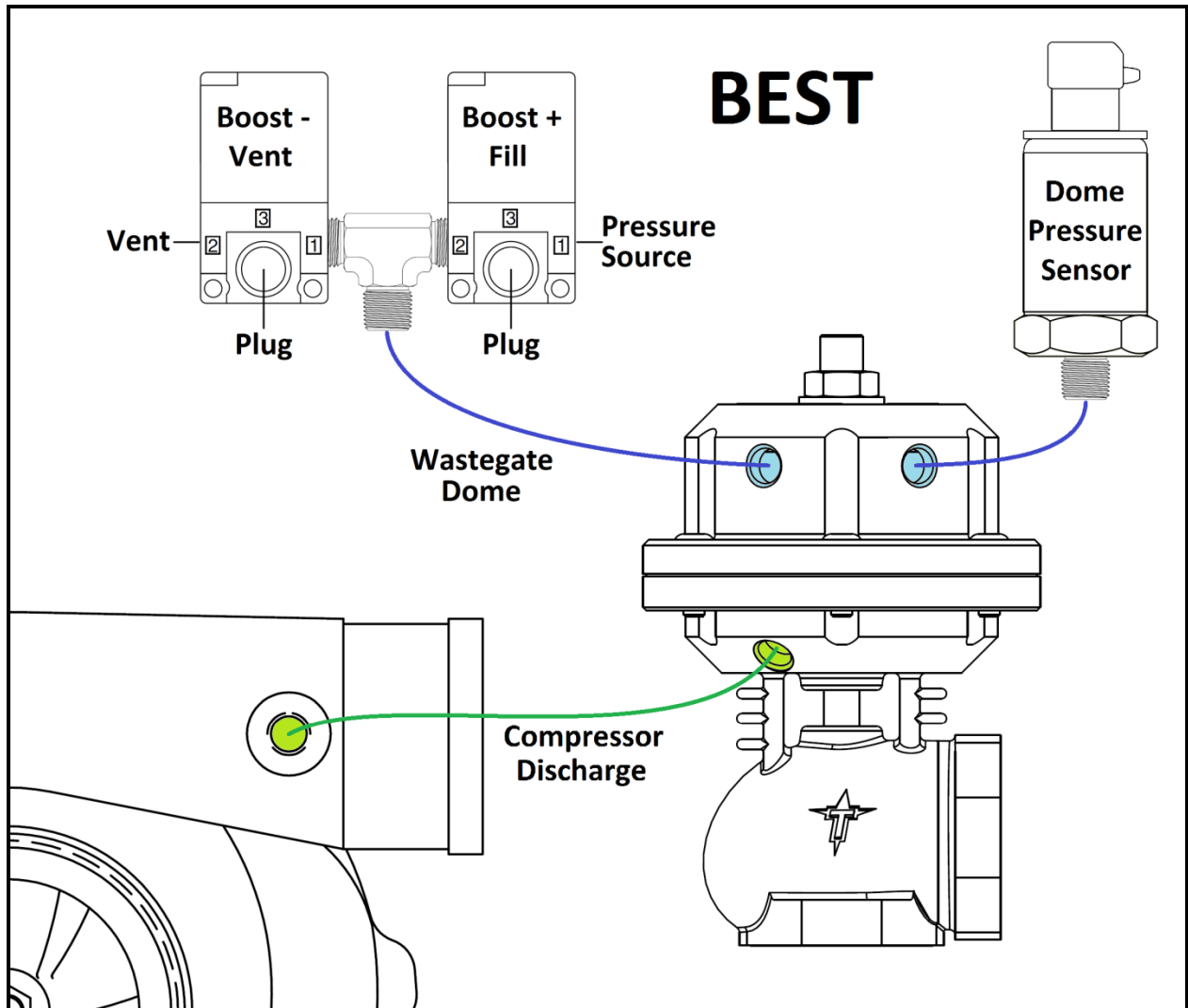

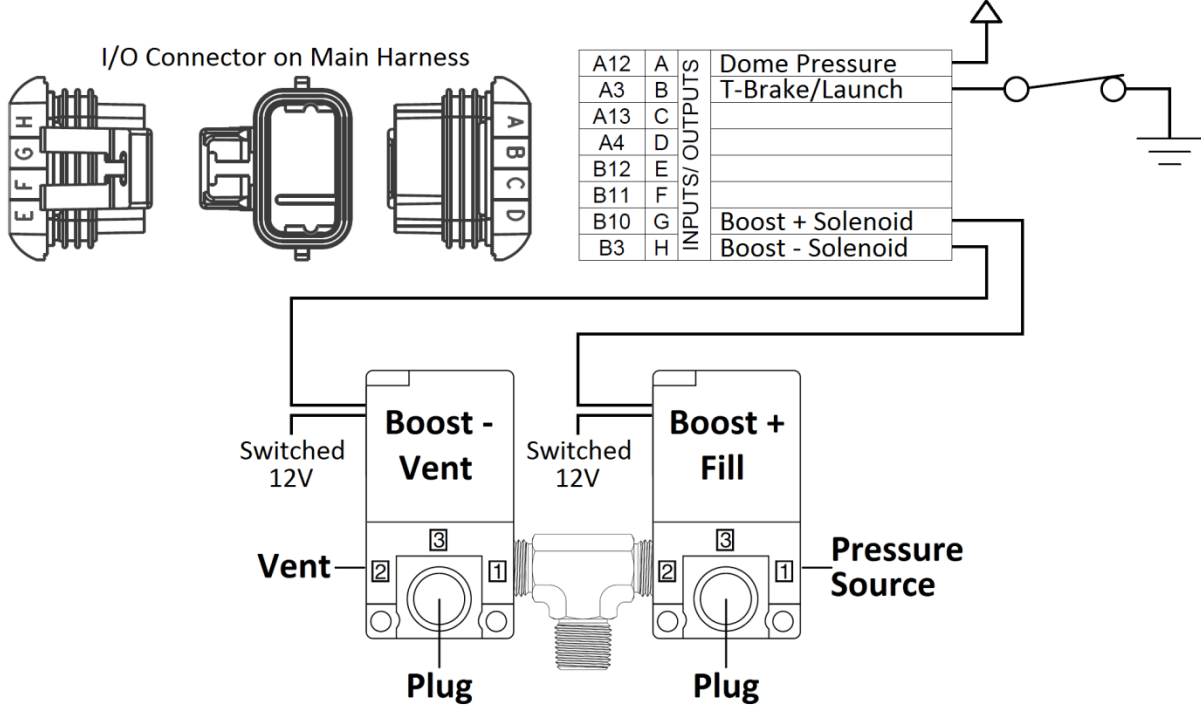
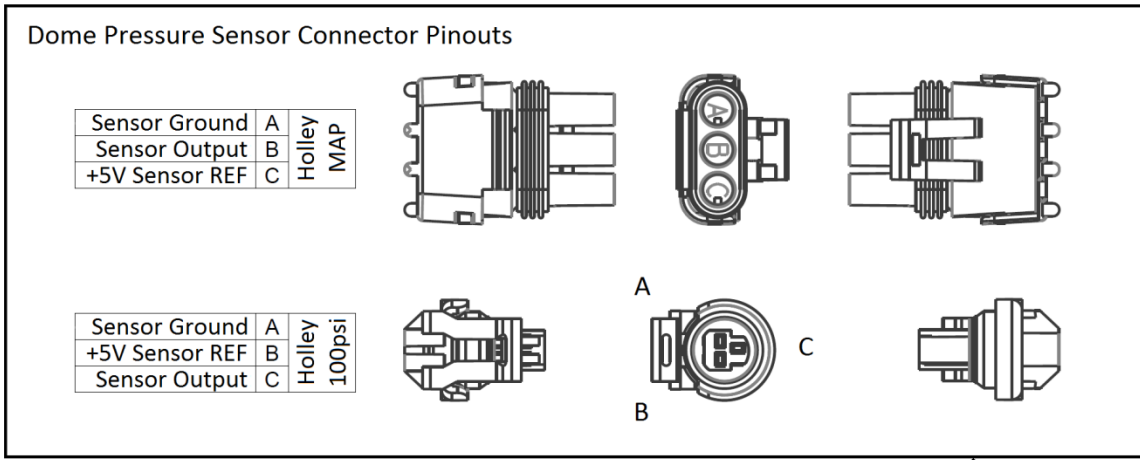

8.2 PID CONTROLLER TUNING INFORMATION

8.2.1 Concepts

Because of the general philosophy of the boost control implementation that keeps you in control, you need to be comfortable making decisions about critical parameters. Because of differences in wastegate dome volumes, hose sizes, sensor mounting, etc. there is not a one-size-fits-all PID tuning for optimum performance. Tuning that works perfectly on your friend's car may not be stable on yours. In the very least you need to be able to recognize "that ain't good" and have an idea what to do about it. As obvious as it sounds, knowing what you are doing is a competitive advantage.

The PID control loops integrated into the Holley EFI system are of the ideal parallel form where the P gain does not affect the I or D gain such as is common in the automotive field and robotics. The gains are independent so that changing one does not change another, and are not expressed in terms of time as is common in some industries. The gains are arbitrarily scaled such that the coefficients that the user would input are within a certain positive range. Larger gains mean more response to error. Smaller gains mean the controller will respond less to error. Big gains= hyperactive and potentially unstable. Small gains= lazy. Any one of the three PID gains can cause instability, but to a certain extent they can be counteractive. For instance increasing the D gain can allow you to run a P gain that would otherwise cause objectionable overshoot. In

general, there is always a compromise between controller performance and stability. Our advice is to start with a bias toward stability. When it comes to gains, more is not always better. Think "just enough."

There are different ways to think about how a PID control loop works using mechanical analogues.

You can think about the **P Term** as being like a spring. The further the measured value deviates from the target value, the more the **P Term** tries to "push back" to restore it. A low **P Term** is like a light spring: the restoring force will be low relative to the displacement. A high **P Term** is like a stiff spring: the restoring force will be high relative to the displacement.

If you are familiar with heavy truck suspensions the **I Term** is much like the leveling valve on an air suspension system. It will slowly add or vent air to make sure that the suspension returns to a normal ride height when the load changes. It is slow enough that if you hit a bump and the suspension moves up temporarily it has a negligible effect, but the longer things are away from the target the more it builds up a restoring force. It may take a while but eventually it will build up enough force to get things into equilibrium at the setpoint. The **I Term** corresponds to how quickly this happens. A small **I Term** will take a long time to get things where they should be, and a large **I Term** will operate more quickly.

You can think about the **D Term** as being like a damper or "shock absorber." A shock absorber (without a gas preload force) is actually very easy to extend and compress if you are doing it slowly. If you try to do it very quickly you will see that it takes herculean strength. In a similar way **D Term** responds to how quickly the feedback (measurement) is changing. If the feedback is rapidly changing the **D Term** will "put the brakes on" to slow things down.

Practically speaking, you can go overboard with high PID terms. You might be wondering what the downside is to having high PID terms, since they seem to do good things. Ultimately this is related to not being able to implement the system perfectly. Ideally the feedback mechanism would be accurate and fast, but all of the sensors we use have delays and noise on the signals. The ECU also cannot sample them infinitely fast or accurately. The actuators certainly have delays and nonlinearities. All of this combined means that with high enough gains things can get "out of phase" with reality. If this is too far from ideal, the effect of the controller output can actually make things worse and cause oscillation. This applies to the P and D terms. In theory the **D Term** would only contribute to stability, but it is more complicated because it responds to speed. Estimating speed is a rate-of-change calculation, which inherently harder to calculate quickly and accurately.

The point of diminishing returns with the **I Term** relates to relative timescales. Using the suspension example you certainly wouldn't want your truck to dump the air in the bags because a wheel drops down in a pothole going down the road. You intentionally want the **I Term** to not overreact to errors that are short in duration. An **I Term** that is too high (particularly when the **P Term** is too low) can cause low frequency hunting after step changes. Some amount of limit cycling may be unavoidable with "deadbands" in actuators, but the magnitude should be quite low. If you have a long overshoot of over 15% or so as a result of a large step change, consider reducing the **I Term**.

8.2.1 Trying it out

For higher speed loops like the dome pressure control, it is prudent to take advantage of the high speed internal logs. You cannot make good judgments about the gainset of a controller if the response time gets even remotely close to the sample time, as can be the case with PC logs.

The steps below are not a magic recipe, but it can get you started. It is manual and subjective. There are many opinions about how to tune a PID properly. If you have a better method, use it. Just be aware that the coefficient scaling and derivative calculation and filtering that is done will throw off some of the theoretical methods and system modeling software.

1. Start by making sure you have an arrangement that is safe. Manual PID tuning methods tend to flirt with the boundaries of being out of control. We strongly recommend starting off by trying to tuning a dome

pressure control PID using shop air as the pressure source since you can do that without the engine even running. Tuning a boost control PID live on the street would be reckless and irresponsible. For some applications, it is well worth booking some time on a chassis dyno to have a controlled environment. In general make sure that you have appropriate safeguards in the event of overspeed and overboost. Do not count on the USB link between your ECU and laptop for communicating safety critical information.

2. Insure the applicable activation thresholds are set such the controller will actually work and set the gains to zero.
3. Setup a way to introduce controlled step changes in the range of interest. One way to do this is to use the **Trans Brake / Launch** or **Boost Scramble** inputs. Introducing sharp step changes of the target is a good way in invoke oscillation. Switching between 20% and 80% of the system range is a good place to start. In other words if you think you are going to be operating up to 30psig of dome pressure, switch back and forth between 6 and 24psig.
4. This step can be done live or through a sequence of offline tests. Zero the P, I, and D terms. Start increasing the **P Term** until oscillation is observed. It is probably worth pointing out the difference between oscillation that decays and oscillation that does not. Technically what we are looking for is increasing the **P Term** until the oscillation will not decay, but you may or may not want to expose the system to that condition. Sometimes things may look OK until a step change of the target occurs. That is why being able to generate step changes in demand is a useful thing. In any event the advice is this- increase P to the point of oscillation and then immediately divide it is half. This **P Term** (half the value when oscillation ensues) represents the maximum recommended **P Term** to insure an adequate stability margin.
5. Play around with the system with the newly established **P Term** to insure there are no areas that cause oscillation. There may be overshoot, but you should not be able to invoke a oscillation that takes a while to decay. If you can, the P term needs to be decreased a bit more. For reference many times a dome pressure target of approximately half the source pressure is a good place to check stability.
6. Start reducing the **Target Rate Limiter** until you get a feel of how this affects overshoot and stability.
7. Note that satisfactory results can usually be had using a D term of "0" (just utilizing the P and I components). If you want to really fine tune things, start increasing the **D Term** until you get a feel of what it is doing. Making small increases to the **D Term** will slightly slow down the response to a step change but will decrease the overshoot that may be present. At some point there will be a point of diminishing returns. In some cases increasing the **D term** will actually make the system more jittery and unstable. If it looks like the **D Term** is causing oscillation, you are probably on the order of four times too high.
8. Decide if the steady state error of the controller is good enough for you. For some systems, eliminating steady state error is not actually all that important. For instance if you are controlling manifold pressure and dome pressure, the inner loop (dome pressure) doesn't have to eliminate steady state error because the outer loop will adjust the inner loop's setpoint to compensate. If you have steady state error and you need to get rid of it, the **I Term** is your mechanism. Simply put the P part responds to instantaneous error while the **I Term** responds to accumulated error. The longer an error is present, the larger the restoring force the **I Term** accrues. The magnitude of the **I Term** determines how quickly this builds. With a small **I Term** the controller will require a longer time to converge to the target. A large **I Term** will cause the system to react faster. The tradeoff is the resultant overshoot, which is why it is good to use only as much as you need. If the **I Term** is much too high it will cause a slow oscillation.
9. Once you have a baseline gainset established you might find that with all three parts in place the individual terms behave slightly differently. At this point the gain tweaking process is iterative. You can revisit each term to try to achieve better performance, but avoid getting greedy before you get significant runtime on the system.

8.2.3 What to look for

At the most basic level the controller is successful when the state of the system (the measured feedback) is close enough to the desired target (the setpoint). Your car may be running great, but if the feedback is not hovering around the setpoint the system is out of control. For instance if you are demanding 5psi of boost and you are getting 15psi, something is not right. The engine may be perfectly happy at 15psi of boost, but it is not in control. The same thing that may lead to 15psi of boost one run may lead to 25psi the next run. It would be wise to stop and figure it out. What is close enough is up to you, but it would certainly not be unreasonable to expect a dome pressure controller to get to within 10% of the target in 0.5 seconds.

The other key criterion to success of the controller is stability. Stability does not mean never having error. In this context we'll say stability means staying within an acceptable window. If the PID terms are incorrectly set the system could oscillate or "hunt." When this happens the measured feedback will go up and down significantly even if the target is steady. It is common to have spikes and excursions caused by sensor noise and wastegate motion, but there should not be "roller coaster" motion of the feedback or the *Boost Solenoid Duty*. If either one of these are hunting more than about 5%, you need to revisit the PID tuning.

One thing to be aware of is the instability that results from reversed wiring or plumbing. If you switch the wiring of boost control solenoids in a two solenoid system the controller will not successfully regulate pressure at all. It can flip-flop back and forth and cause the controller's response to make no sense. If the system senses a pressure higher than the target it will try to actuate the vent solenoid. If the ECU's vent solenoid output is wired to the fill solenoid the pressure will probably increase even more. If you have the plumbing wrong on a single port wastegate system with a single solenoid, you can reach potentially dangerous levels of boost that the controller cannot avoid. In this configuration, if the solenoid is unplugged you should be able to blow through it. In this case if the solenoid is unplugged the boost pressure should be purely a function of the wastegate.

If you cannot stabilize the system even with a low **P Term**, there are a few things that you can do.

Try to decouple the sensor from the pulsations of the solenoids. Resist the urge to put the dome pressure sensor close to the solenoids. Instead put the dome pressure sensor as close to the dome as possible. A dedicated pressure port on the dome for the pressure sensor significantly reduces the effects of the pressure pulses from solenoids. This is not saying you have to direct mount the sensor to the dome, but connecting to the dome volume with a separate port is good even if there is a length of hose between the sensor and dome.

There are variations in the response time of solenoids that can sometimes destabilize the system. If the solenoid reacts faster than what is specified in the **Solenoid Dead Time** curve the solenoids can deliver more than expected. This can cause oscillations even in conditions that should be very steady. If you think this could be a problem, you can change the **Solenoid Configuration** to "Custom" and reduce the values that are in the curve. Refer to the section on solenoid dead time for more information.

If you are not satisfied with the stability of the system you can greatly affect it by changing the volume in the dome pressure control pneumatic circuit. Increasing the volume of the dome pressure control fundamentally improves the stability of the system at the expense of slew rate capability. If you do not need to make snap changes in the dome pressure, adding volume can "tone down" the jitter of the system.

There can be boost spikes in the system that are impossible to truly fix with a traditional wastegate control system because they are rooted jointly in sudden changes in engine flow and the characteristics of the compressor. As such it is important to recognize if a spike is a result of controller tuning or is an expected result of the turbo's configuration. Oftentimes spikes that occur after upshifts cannot be controlled well by PID settings.

The compressor will have a "sweet spot" when you are looking at a conventional map of pressure ratio vs. massflow. If you are looking at a line of constant pressure ratio (boost), if you go too low in massflow the compressor can surge and if you go too high the flow will be "choked." Toward the left side of the compressor map you will see that the lines of constant speed are almost flat. That means that for a range of massflow the

turbo speed does not have to change much to keep a constant boost. Toward the right side of the map you will see that the lines of constant speed have significant slope. This means as you approach “choked” conditions the boost decreases significantly if you maintain the same turbo speed. Another way to think of it is that the turbo has to speed up considerably in order to deliver the same levels of boost.

In the graphic below there is a single line of constant turbo speed highlighted in red. It has two points in blue labeled A and B. Imagine that the engine is operating at point A at a pressure ratio of approximately 2.25 (roughly 18psig boost). If the engine speed suddenly decreases from an upshift event, the volumetric flow (dictated by the engine) will also experience a sudden decrease and subsequently cause a sudden drop in the compressor massflow. Remember, just like you cannot instantly change the speed of the car because of its inertia you cannot instantly change the rotational speed of the turbo because of its inertia. So what would happen if the turbo was at point A at a constant speed and the flow drops suddenly? Like it or not- the pressure ratio would increase. It is a property of the compressor. If you are operating at point A and you suddenly reduce the flow to point B, if the turbo speed remains the same no matter what you do with the wastegate you will get the pressure ratio that corresponds to point B. This is a transient situation of course and the wastegate will be venting exhaust and the turbo will slowing down (you may not reach point B), but in the meantime you will have a boost blip as illustrated in the datalog below. It is also worth pointing out that the dome pressure spike that often accompanies the boost pressure spike can actually be caused by the wastegate motion as it responds to the higher boost. You will also see that the dome pressure spike is often lower than the boost pressure spike. This does not happen if the dome pressure spike is the cause of a boost spike.

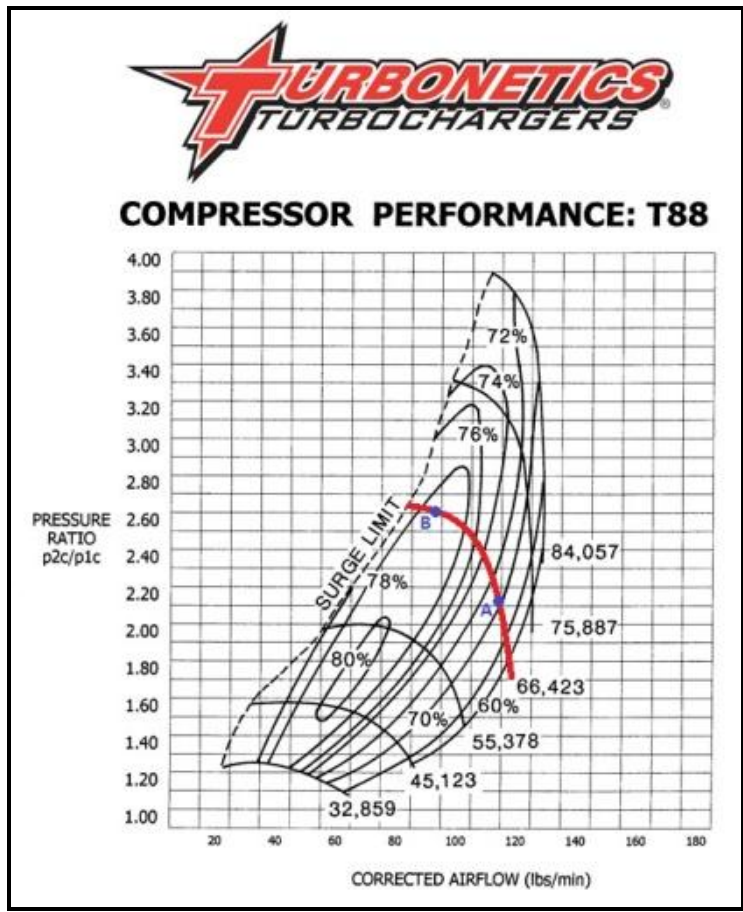

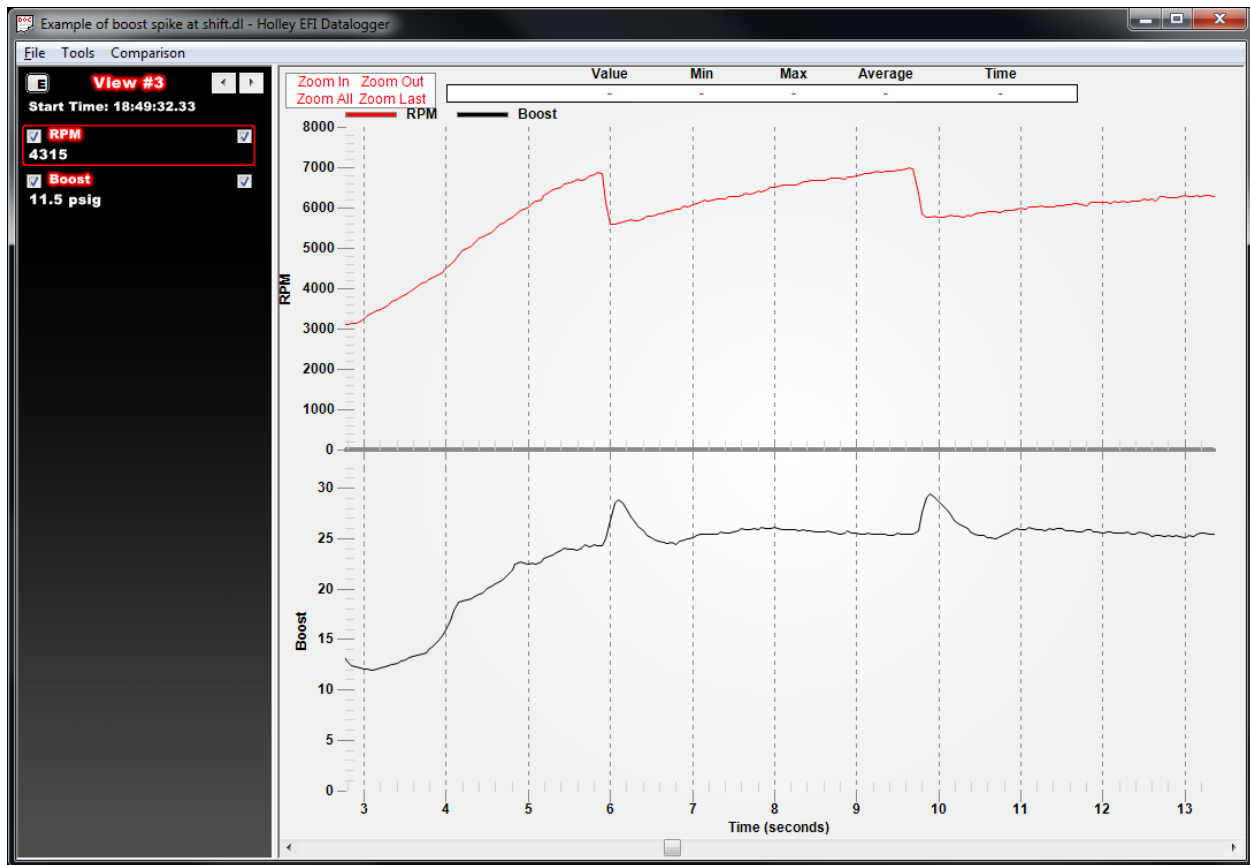

If the boost spikes are unacceptable because of traction or mechanical limitations there are a few things you can do. Firstly, you could decrease your boost (or dome pressure) demand before you know a shift would occur. Obviously this would have a direct power penalty, but it would not require a hardware change. Secondly, you could simply go to a larger compressor that would result in a lower turbo speed change during shifts. The potential downside to this is that you would reduce the surge margin. There are significant differences in effective map width between wheel and housing styles, so it is worth evaluating your options. Thirdly, you could use an auxiliary device to either increase massflow (venting boost) or introduce a pressure loss between the compressor and intake (throttling). It would be possible to mitigate the effects of a shift induced compressor discharge pressure spike with an appropriate reduction in DBW position setpoint, but this is not something that is currently supported in software.

8.2.4 An example of the effects of the P Term

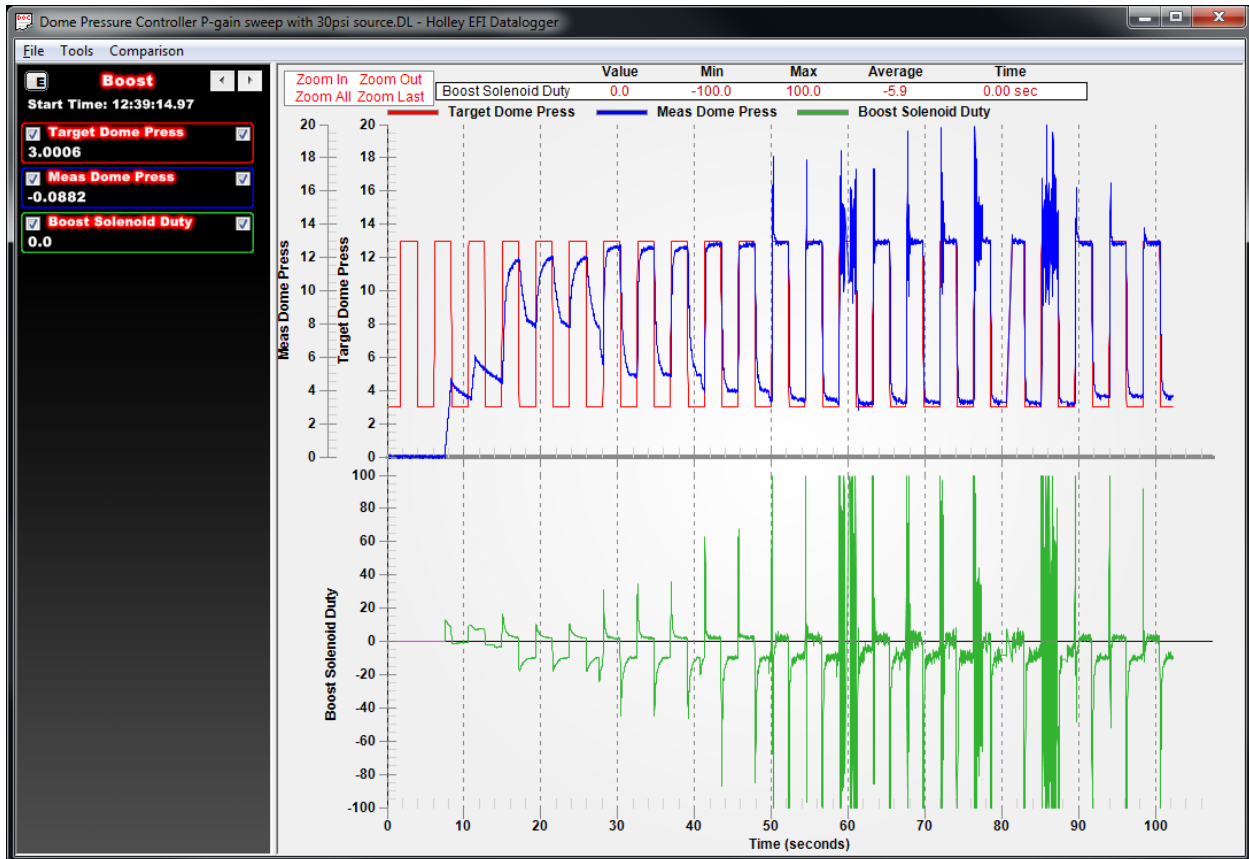

The datalog above is a recording of dome pressure controller activity when varying the **P Term**, while the **I Term** and the **D Term** were zero.

This was setup as a “Dome Pressure Only” control method and the dome pressure target was switched between 3 and 13psig every two seconds for the purpose of this test. You can do the same thing by setting your normal curve (say **Boost vs RPM**) to 3psig and your **Launch Target** value to 13psig. Switching the launch input back and forth would then switch the dome pressure target between 3 and 13psig.

The upper panel has two traces. The red line is the target dome pressure and the blue line is the measured dome pressure.

The lower panel has a single green line that represents the output of the dome pressure PID control. Recall that positive duty cycles mean that the “fill solenoid” is active and negative duty cycles mean the “vent solenoid” is active. In other words if the *Boost Solenoid Duty* is 37%, that means the fill solenoid will be PWM’ed to try to achieve 37% of max flow. This will probably not be 37% duty cycle because of the voltage compensation. If the *Boost Solenoid Duty* is -45%, that means the vent solenoid will be PWM’ed to try to achieve 45% flow.

What you see in this sequence is the controller’s response when starting with a **P Term** of zero, gradually increasing it until the oscillation limit was found, and then backing off from that level.

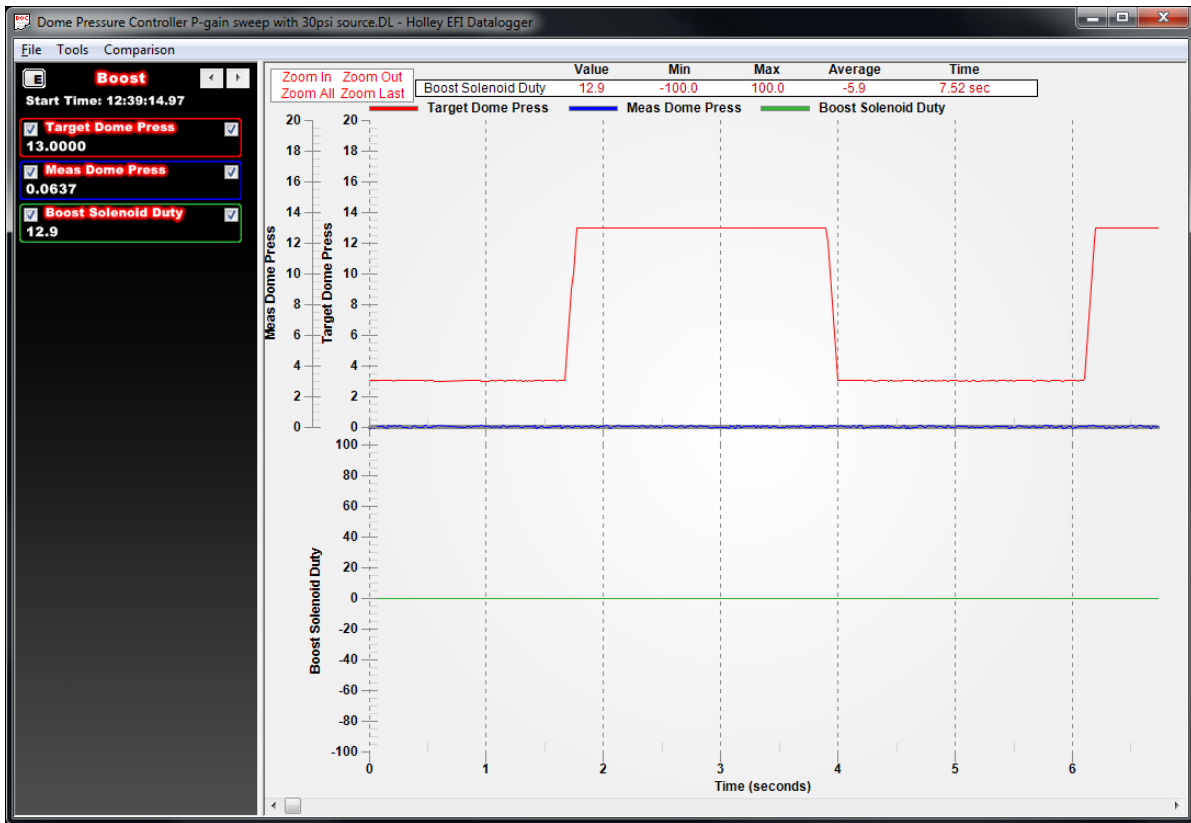

The datalog above is a recording of dome pressure controller activity with a **P Term** of 0. The target is moving but the *Boost Solenoid Duty* is not. It should then come as no surprise the measured dome pressure does nothing.



The datalog above is a recording of dome pressure controller activity with a **P Term** of 1. The target is moving and the *Boost Solenoid Duty* reacts. You can see that when the dome pressure target is higher than the measured dome pressure the *Boost Solenoid Duty* goes up. It just does not go up enough to do much.

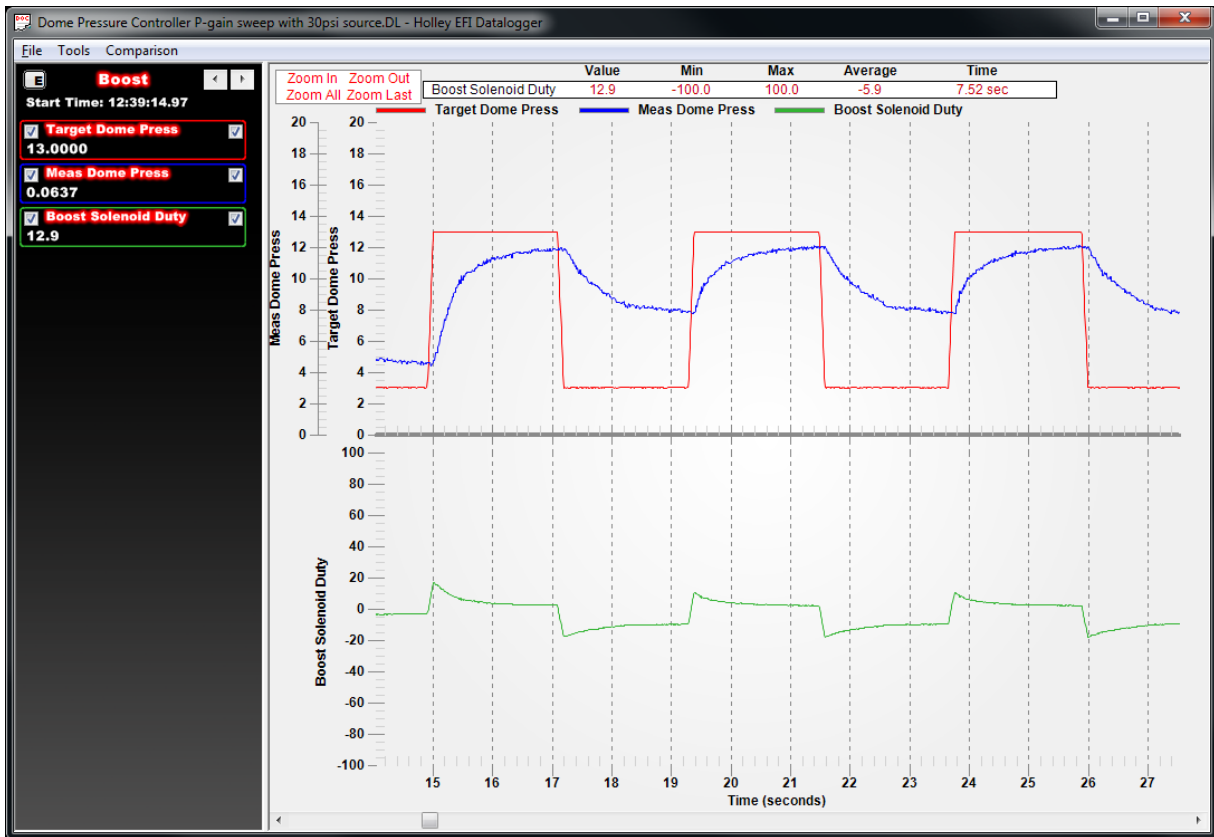

The datalog above is a recording of dome pressure controller activity with a **P Term** of 2. You can see that the *Boost Solenoid Duty* is doing more and the measured dome pressure is getting closer to the target, but it is very slow and not going far enough.

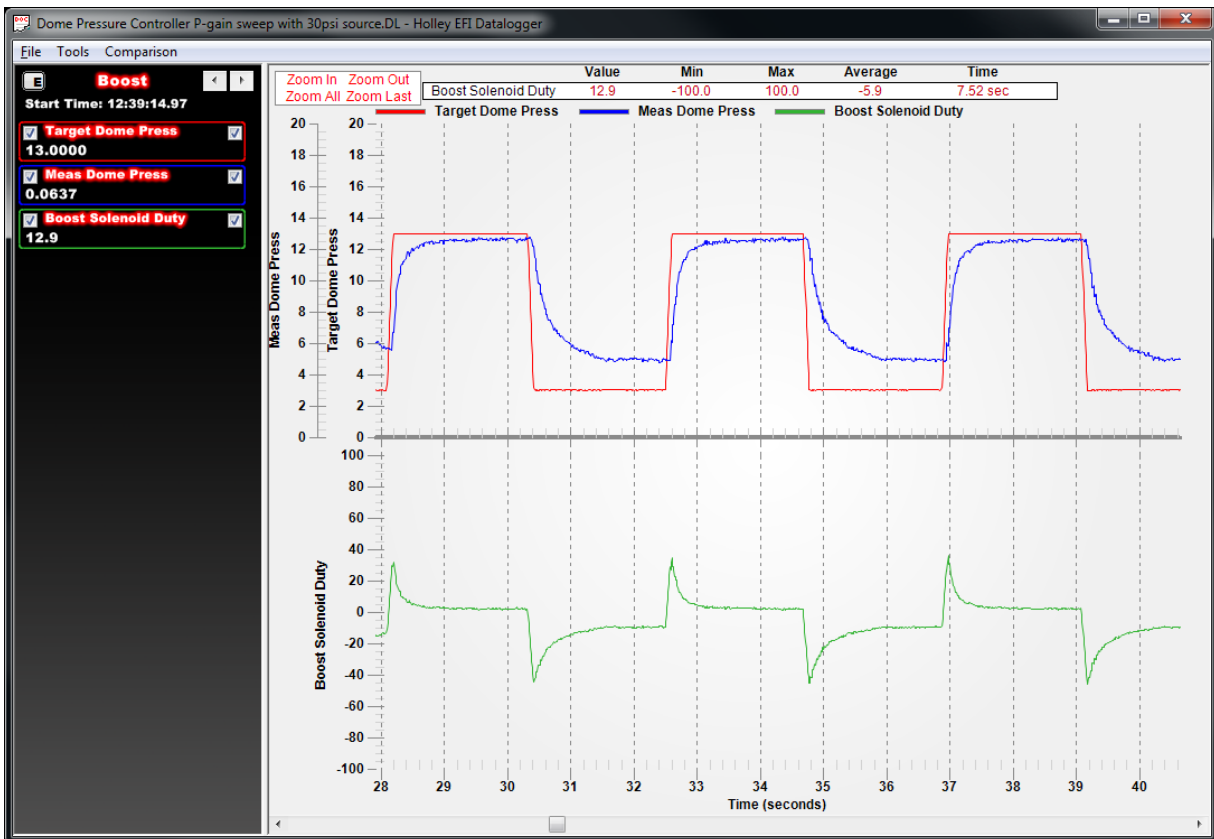

The datalog above is a recording of dome pressure controller activity with a **P Term** of 5. You can see that the *Boost Solenoid Duty* is doing more and the measured dome pressure is getting closer to the target, but it is still a bit slow and is stabilizing too far from the target. You can also see that even after large changes in the target, the *Boost Solenoid Duty* is only hitting around 30-40%. So we need to work it a bit harder.

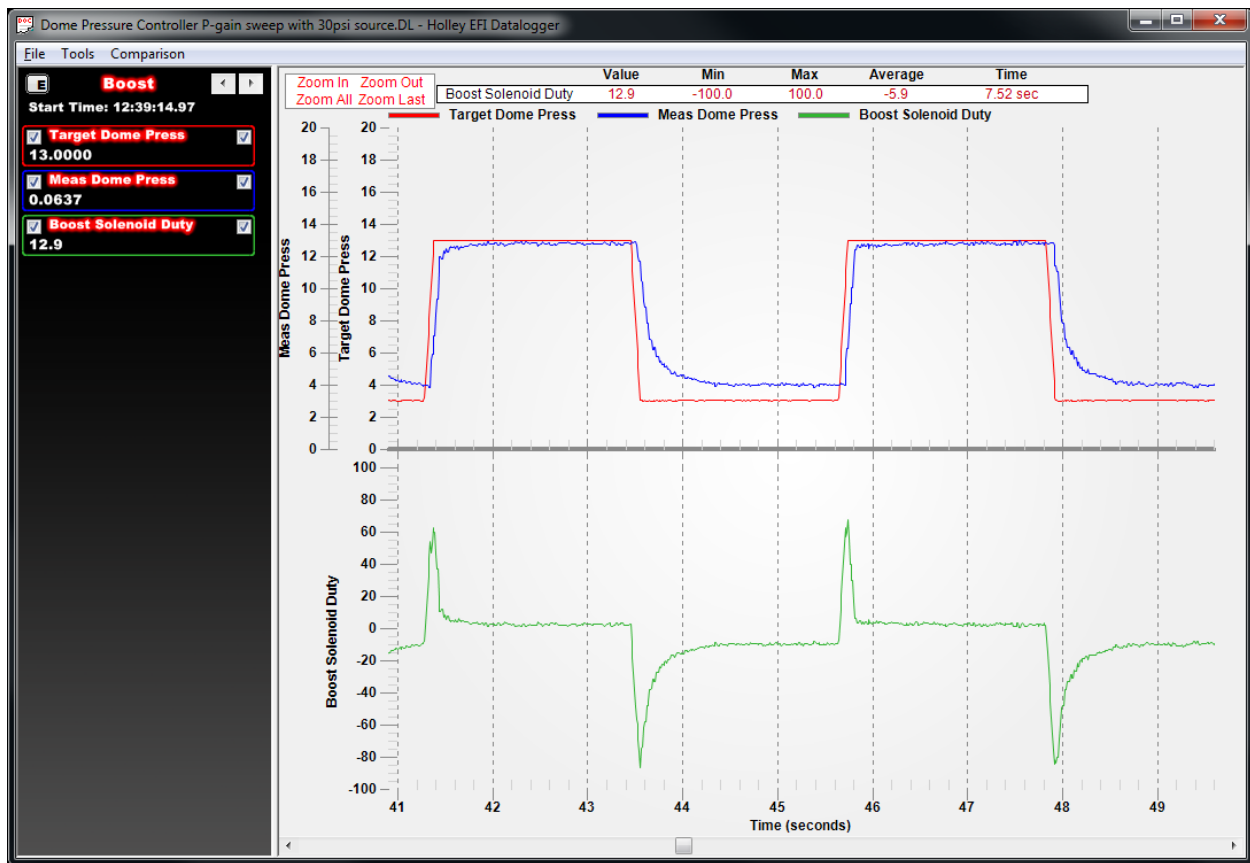

The datalog above is a recording of dome pressure controller activity with a **P Term** of 10. Now we are getting somewhere. It is getting near to the target in a respectable time and it is converging closer. Ultimately the **I Term** is very effective at reducing the steady state error, but it is a good sign that the **P Term** is getting us closer. But again, even under rapid changes the *Boost Solenoid Duty* is not maxing out and the measured dome pressure is not overshooting the target dome pressure. This **P Term** would certainly be stable, but it wouldn't correspond to maximum performance.

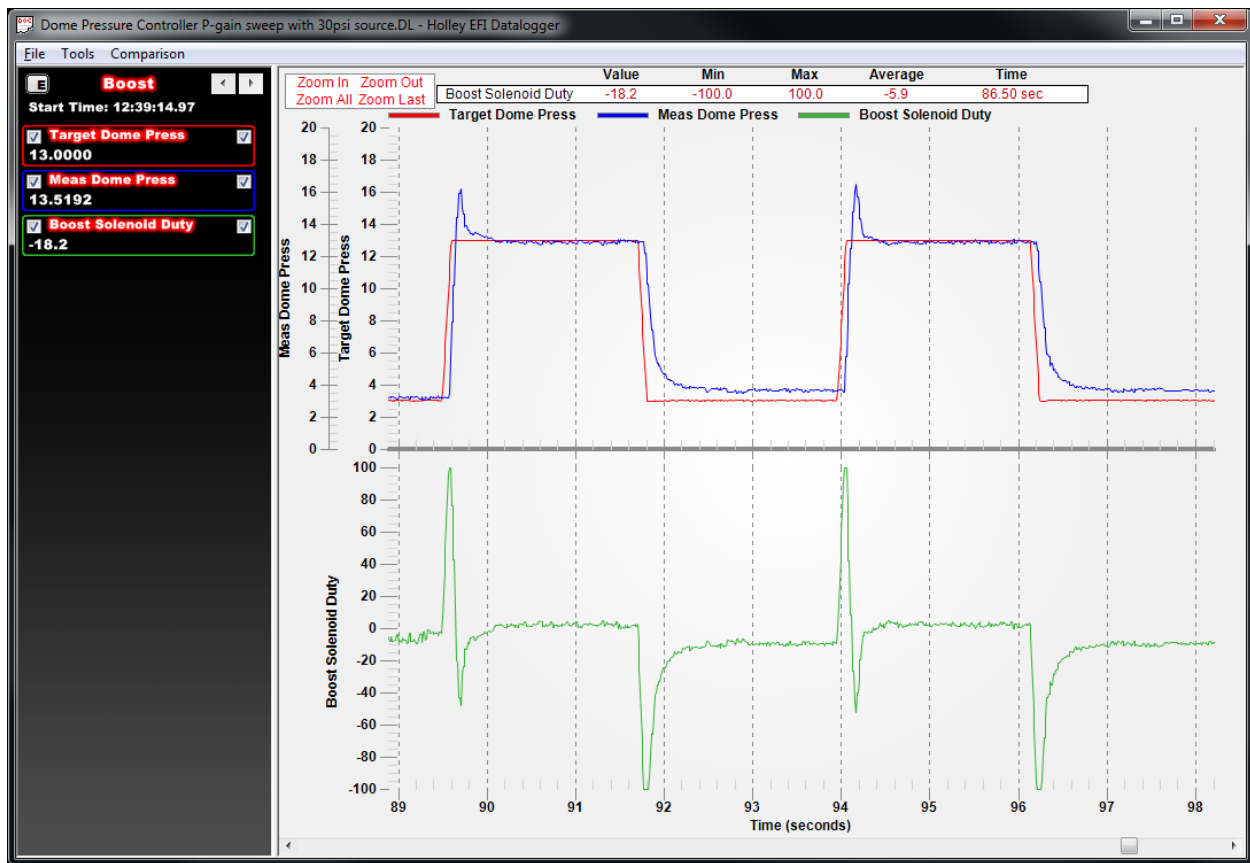

The datalog above is a recording of dome pressure controller activity with a **P Term** of 15. This is the first one that exhibits any kind of overshoot and is using close to the full -100% to 100% range of the solenoids. Practically speaking short overshoots are not a big problem. Even if you could cause an instantaneous change in dome pressure, because of the turbocharger's inertia will not create an instantaneous change in boost pressure. The inertia of the turbocharger tends to "iron out" some of the high frequency features of the dome pressure curve. The pressure overshoots are causing a reversal in the *Boost Solenoid Duty* after sharp increases in demand- meaning the vent solenoid releases a bit due to the "overreaction" of the fill solenoid. This is not a big problem, but it signals you may be getting close to being high enough on the **P Term**.

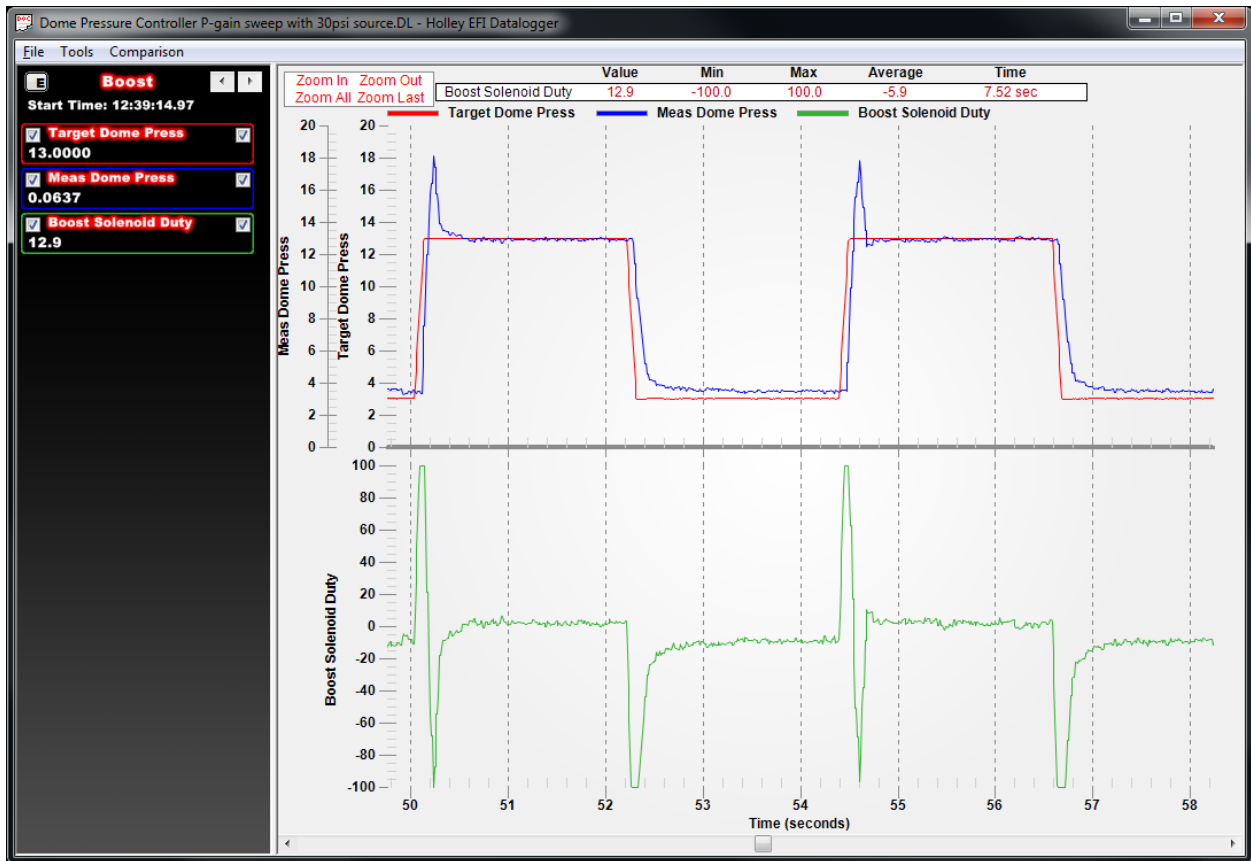

The datalog above is a recording of dome pressure controller activity with a **P Term** of 20. Like the case of **P Term**=15 there is overshoot, but this time the magnitude of the overshoot is getting a bit large compared to the step change. Not only that the vent solenoid is going full on in response to the overshoot, which is not a good sign. The inertia of the turbocharger would still probably mask this overshoot, but it is not ideal.

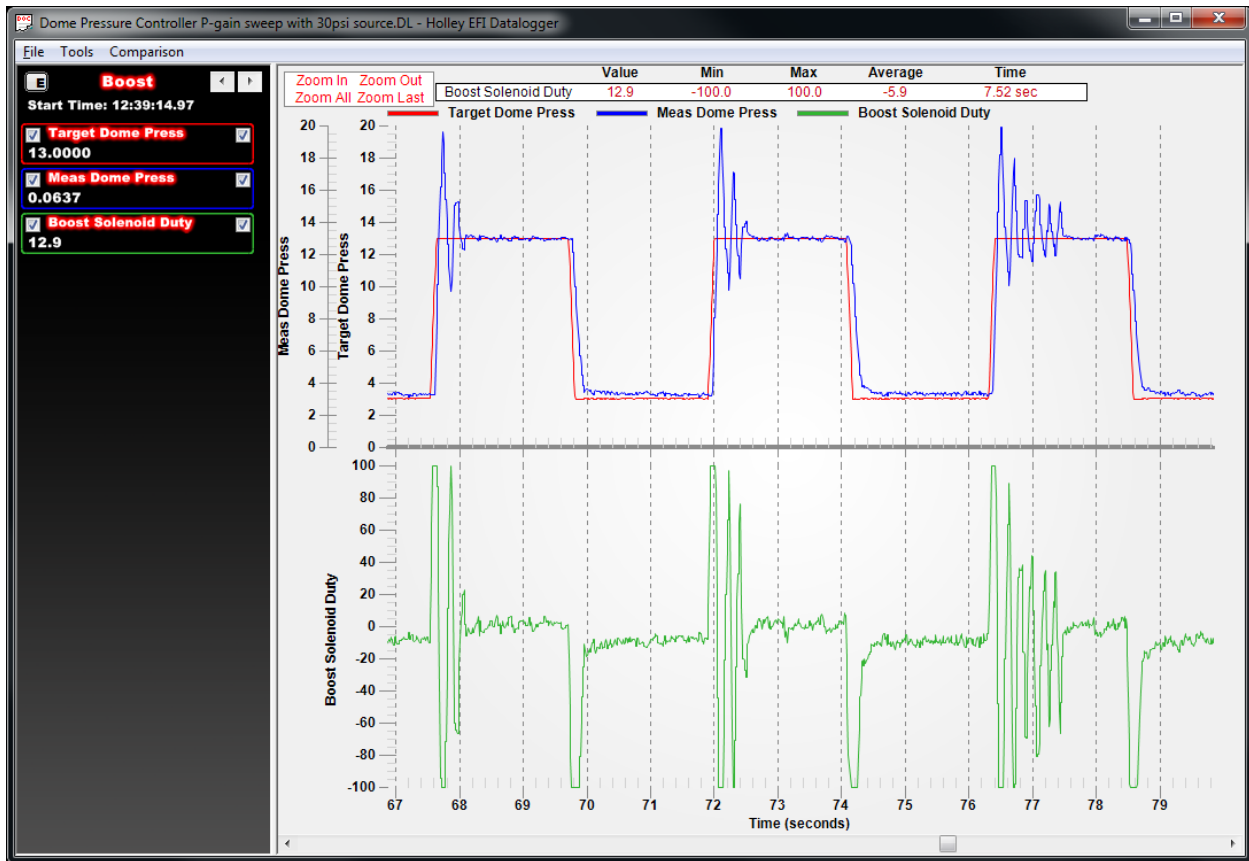

The datalog above is a recording of dome pressure controller activity with a **P Term** of 30. The most noteworthy thing about this response is the fact that there are multiple “rings” of the dome pressure after the step change. This definitely gives you a clue that you are well past the point of robust stability. The ringing does eventually decay, but notice that there are more oscillations in the last step than the first one. This is another clue that you are on the verge of instability. All signs point to “back off.”

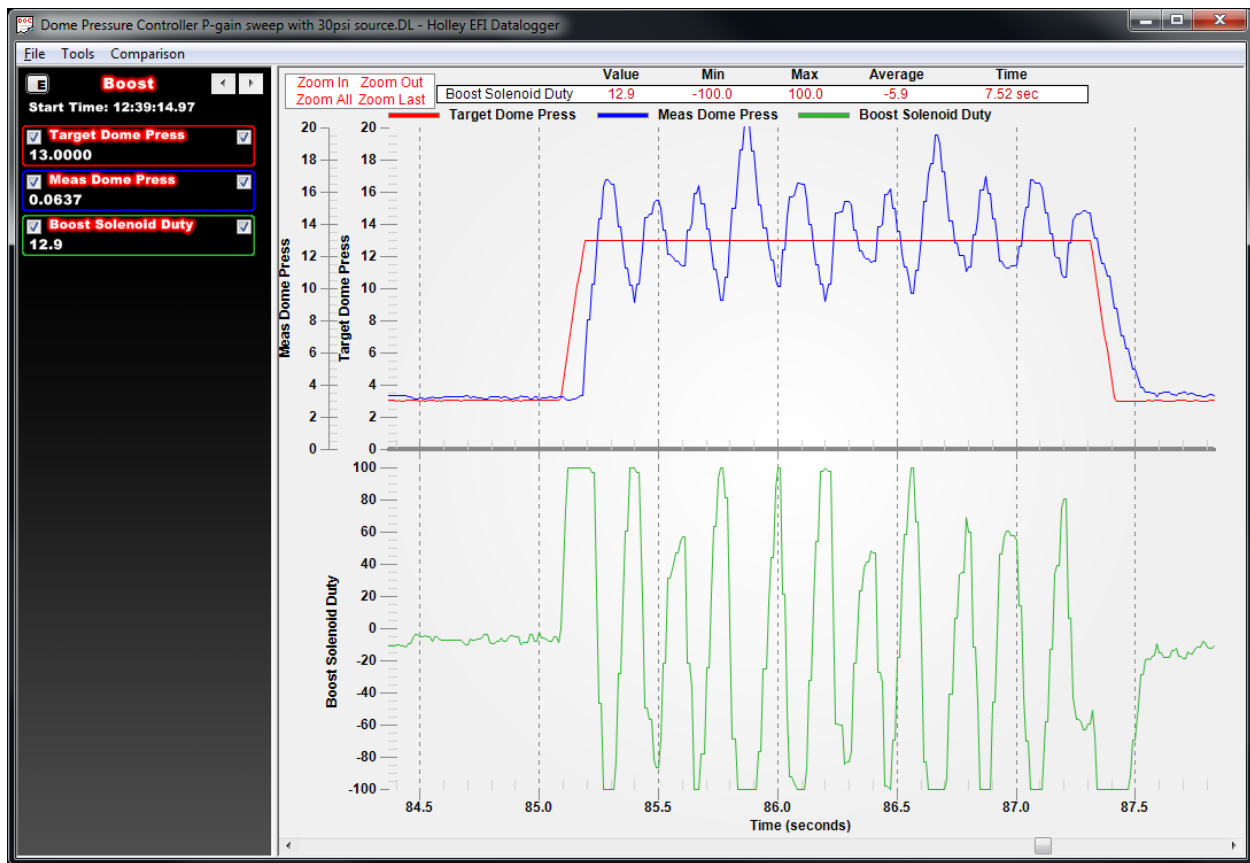

The datalog above is a recording of dome pressure controller activity with a **P Term** of 35. At this point things are out of control. There is oscillation that does not decay. The *Boost Solenoid Duty* is repeatedly bouncing between -100% and 100. This ain't good. But this was a just a test of the dome pressure controller that was done without the engine even running. No harm done- and now we know the ultimate limit. Practically speaking you usually don't want to have a **P Term** that is more than half the **P Term** when oscillation like this happens. That makes a **P Term** of 15 look like a good starting point.

Note: there is a difference between oscillations because the system is out of control and small deviation around the target. The control system will never be perfect and it, by definition, reacts to error. Sensor noise and other system disturbances (like wastegate motion) will cause a little activity. When you start using an **I Term** it is not uncommon to see some slow limit cycling as it traverses through the solenoids' deadband and mechanical friction, which is more or less unavoidable.

8.2.5 An example of the effect of the Target Rate Limiter

The **Target Rate Limiter** limits the rate that the dome pressure target will change and is useful for controlling overshoots. A good time to experiment with this is after you decide roughly what the **P Term** should be. Sudden changes in the target can cause the controller to overshoot the target. If you control how sudden the target can go up or down, you can reduce the chances that there will be a spike in your dome pressure after a target change. It is a subjective tradeoff left up to you. Higher rates enable faster controller response at the expense of overshoot. Lower rates result in greater stability at the expense of fast response.

There are a variety of philosophies that you can use to determine how to set the **Target Rate Limiter**. The "I don't care" philosophy: set it at the max and forget about it. The "just enough" philosophy: lower the **Target Rate Limiter** until you reduce the overshoot to an acceptable level. The "how fast do I really need" philosophy: set the **Target Rate Limiter** to the maximum value that you think you'll want the dome pressure to be changing. You'll have an idea of how fast your base demand will be changing as a function of your boost

curves. Also, if you know your turbo will not spool faster than 10psi/sec there is not much of a reason to ramp the dome pressure excessively quickly.

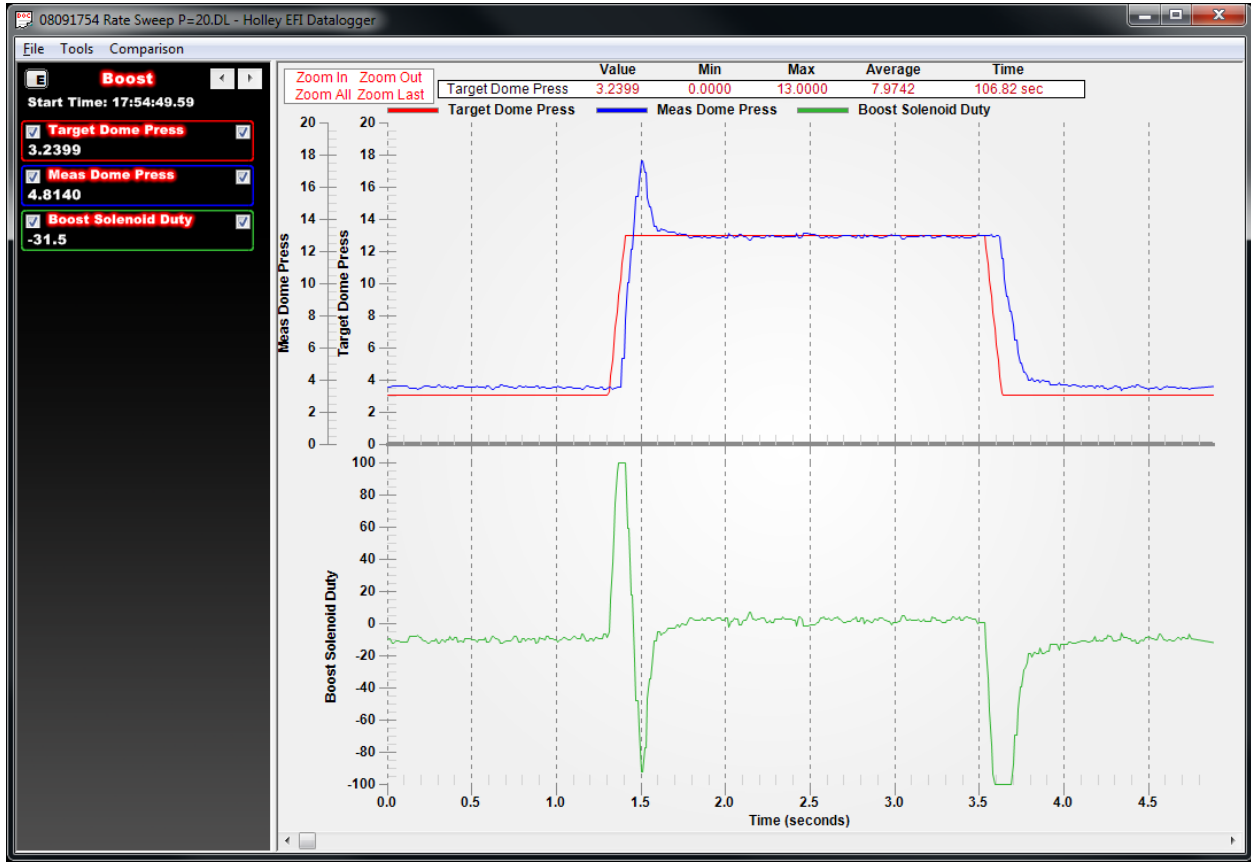

The sequence above illustrates a step change with a 100psi/sec rate limit applied. The PID controller was set with a **P Term** of 20 since that consistently produced a bit of overshoot with the setup under test. You can see that the *Boost Solenoid Duty* went “full on” to +100% and then almost hit -100% in reaction to the overshoot.

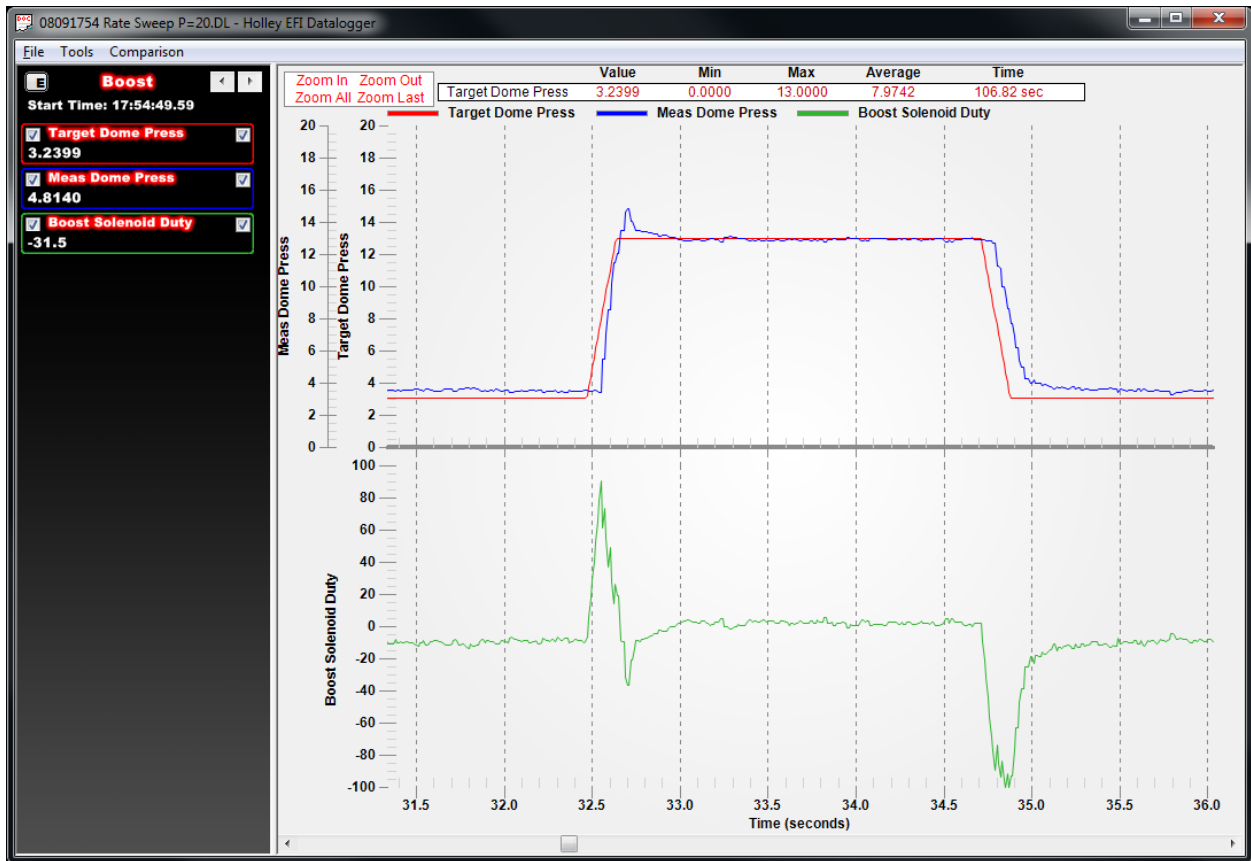

The sequence above illustrates a step change with a 60psi/sec rate limit applied. The overshoot was rather significantly reduced even though the time-to-pressure was still rather fast. You can see that the *Boost Solenoid Duty* was somewhat more tame not going completely to 100%. Since the trajectory to the setpoint was a bit more restrained there was less of an overshoot associated with it. Since the overshoot was less, the negative reaction by the *Boost Solenoid Duty* was much less.

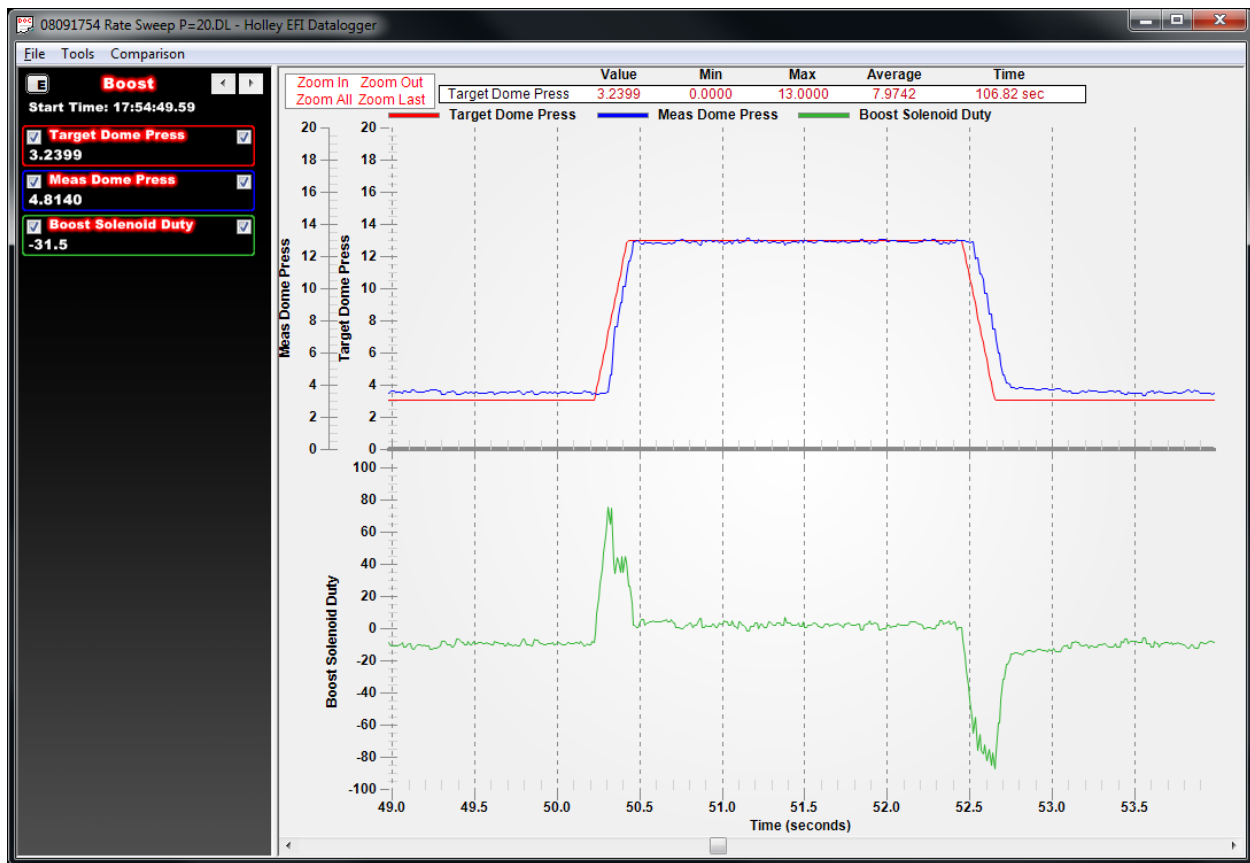

The sequence above illustrates a step change with a 50psi/sec rate limit applied. The overshoot was essentially non-existent. You can see that the *Boost Solenoid Duty* was somewhat more tame and smooth. Recall this is with a **P Term** that resulted in fairly substantial overshoot with a 100psi/sec rate limiter.

In conclusion, the rate limiter can be a useful tool to maintain stability when there are rapid changes in demand.

8.3 SOLENOID DEAD TIME

The **Solenoid Dead Time** is a composite value that captures the combined effects of opening delay and closing delay to compensate the length of time the electrical signal needs to be active. A given solenoid will require a certain time to open, relative to the start of the electrical signal. It will also require a certain time to close relative to the ending of the electrical signal. If the opening time is the same as the closing time the dead time would be around zero. This doesn't say that it opens instantaneously, it only says the length of time the solenoid is open is the same as the time the electrical signal is energized so that no compensation is required. It is "on" the right length of time. It is just slightly late. Most solenoids will require a longer time to open than to close. Our convention is to call this a positive dead time. The opening time strongly depends on the voltage of the electrical signal. The closing time is much less sensitive to the energizing voltage. The net effect is that the composite dead time will usually go down as battery voltage increases.

The ECU uses the deadtime to compensate the pulsewidth to the solenoids so that the output is proportional to the control signal even when the desired output is small. If you do not compensate, there will be a deadband in the response. An analog to this that we are all familiar with is backlash. If you have a worn out steering box that only moves the pitman arm after you put a half turn in the steering wheel, it becomes more difficult to hold a straight line. The deadtime compensation uses the knowledge that there is a certain amount of slack in the system.

It is important to have reasonable estimations for deadtime, particularly if you are using a dual solenoid system. If the deadtime estimates are too low, the deadband is not completely factored out. It is better than nothing, but not ideal. If the deadtime estimate is too high there is a high risk of system oscillation. We have tested the Holley solenoids to characterize the dead time based on our definition. If you do not know what this should be for your solenoid it can be zeroed, but you will not get the best operational performance because of the deadband and repeatability will suffer when battery voltage fluctuates.

Single three-port solenoid arrangements are much less sensitive to deadtime because you are not crossing the range of short pulsewidths in the course of normal control as is the case with a two-solenoid arrangement. In an ideal world, the deadtime would not be a function of battery voltage and you could more or less forget about it. Unfortunately in many of the arrangements where a single 3-port solenoid is used the system tends to be fairly sensitive to duty cycle at high boost levels. This means that the repeatability of the duty cycle is very important. The deadtime compensation improves the repeatability. The graph illustrates how the solenoid response varies with voltage. Luckily when the voltage compensation is applied, the solenoids behave very consistently at different voltages.

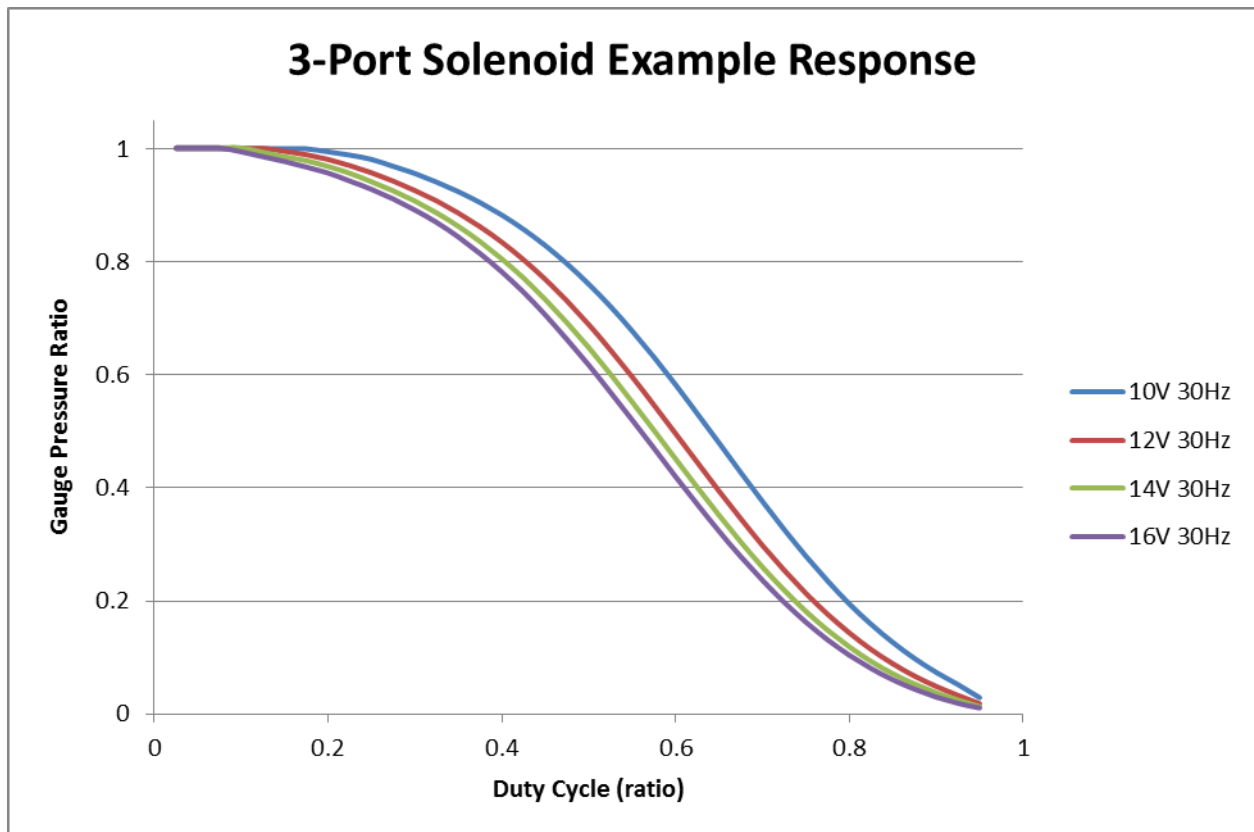

One method to estimate the solenoid deadtime in a two solenoid system is to observe the *Boost Solenoid Duty* when making slow steady ramps in the target pressure. When the deadtime compensation is too low, the *Boost Solenoid Duty* will hover at a non-zero value during these ramps. The log below shows an example of varying the deadtime for each slow ramp of the target. The red line is the demand with a **Target Rate Limiter** of 0.5psi/sec. The raw demand was just switched between 3 and 13psi instantaneously and the excessively low rate limiter creates smooth linear ramps. The controller was setup to be only proportional with a low gain to control noise. The PID in this example was setup with terms of 3-0-0. The first up-down sequence was performed with a deadtime of 0ms, the second with 0.5ms, the third with 1.0ms, etc. up to 4ms. You can see that the last sequence shows more controller activity and noise on the measured dome pressure. This is a giveaway that the deadtime is too high. When we isolated the points in a certain measured dome pressure range (5.5-6.5psi in the increasing direction) and graphed solenoid deadtime vs. *Boost Solenoid Duty*, you can see that there is a fairly linear relationship between the two. The theoretical deadtime is the y-intercept of the best fit of this line. However, for optimum stability it is actually good to underestimate the deadtime. A good

compromise is to try to find the deadtime that results in an average of 2% to 3% *Boost Solenoid Duty* during a slow increase in target pressure. If you have a particularly noisy pressure sensor, it might be of benefit to target a higher duty cycle. The increased “deadband” from underestimating the deadtime will help sensor noise from disrupting stability. The deadtime estimation is best done at multiple battery voltages so that you can find the shape of the curve. If you can only do it at one voltage, you are better off taking an already existing curve and scaling it up or down (with a multiplier) to make it line up with your measurement.

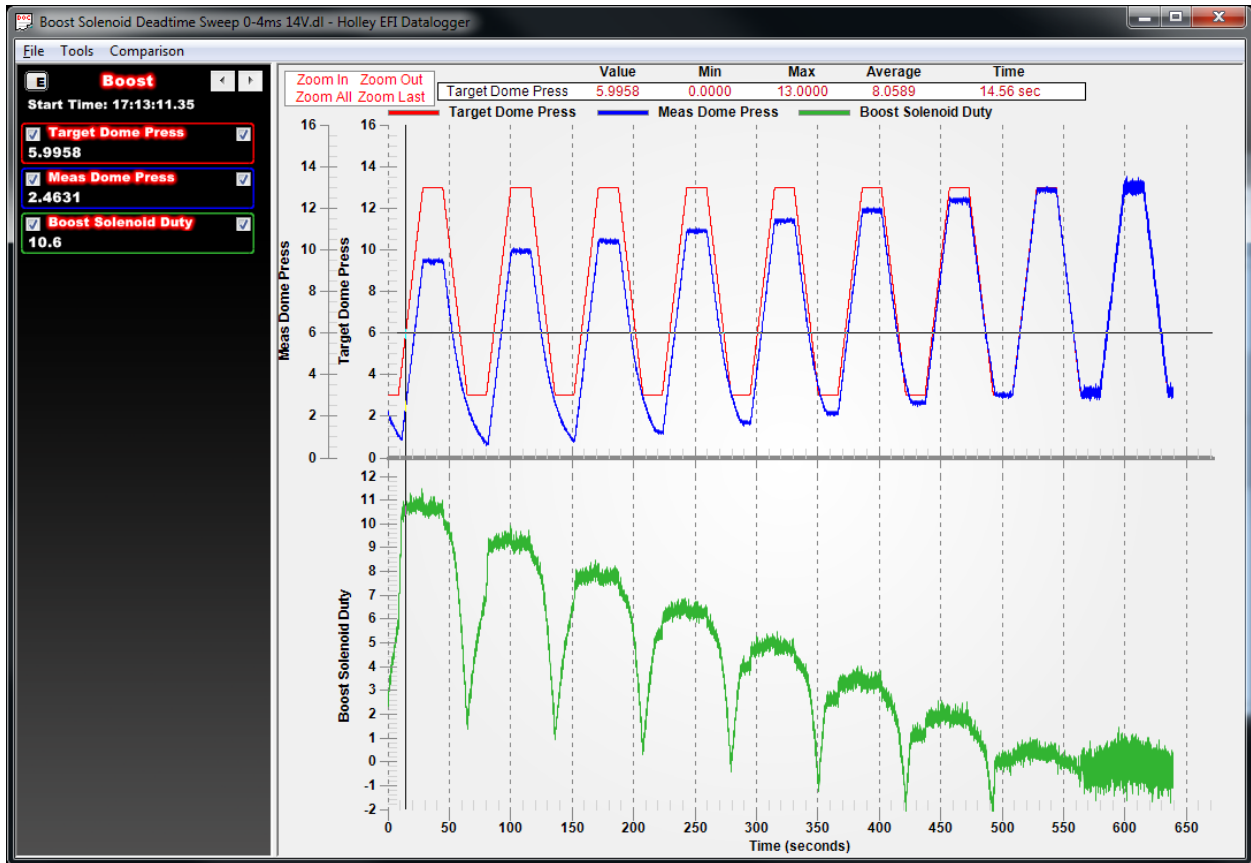

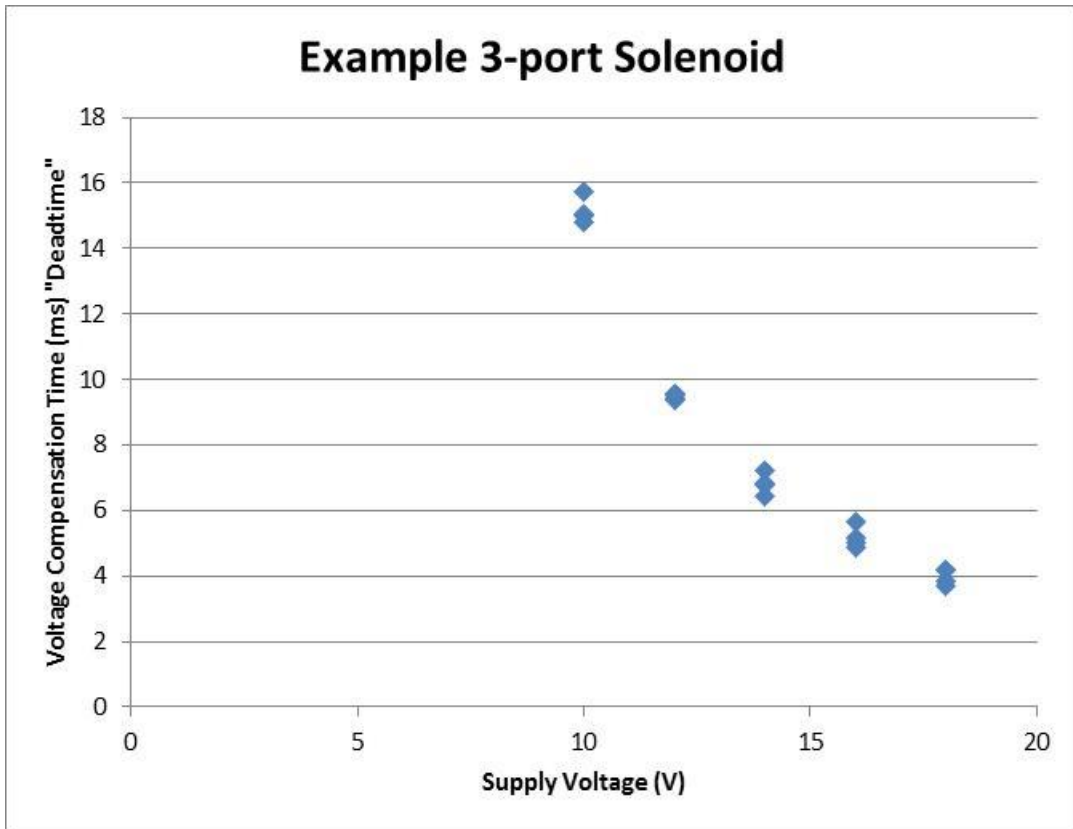
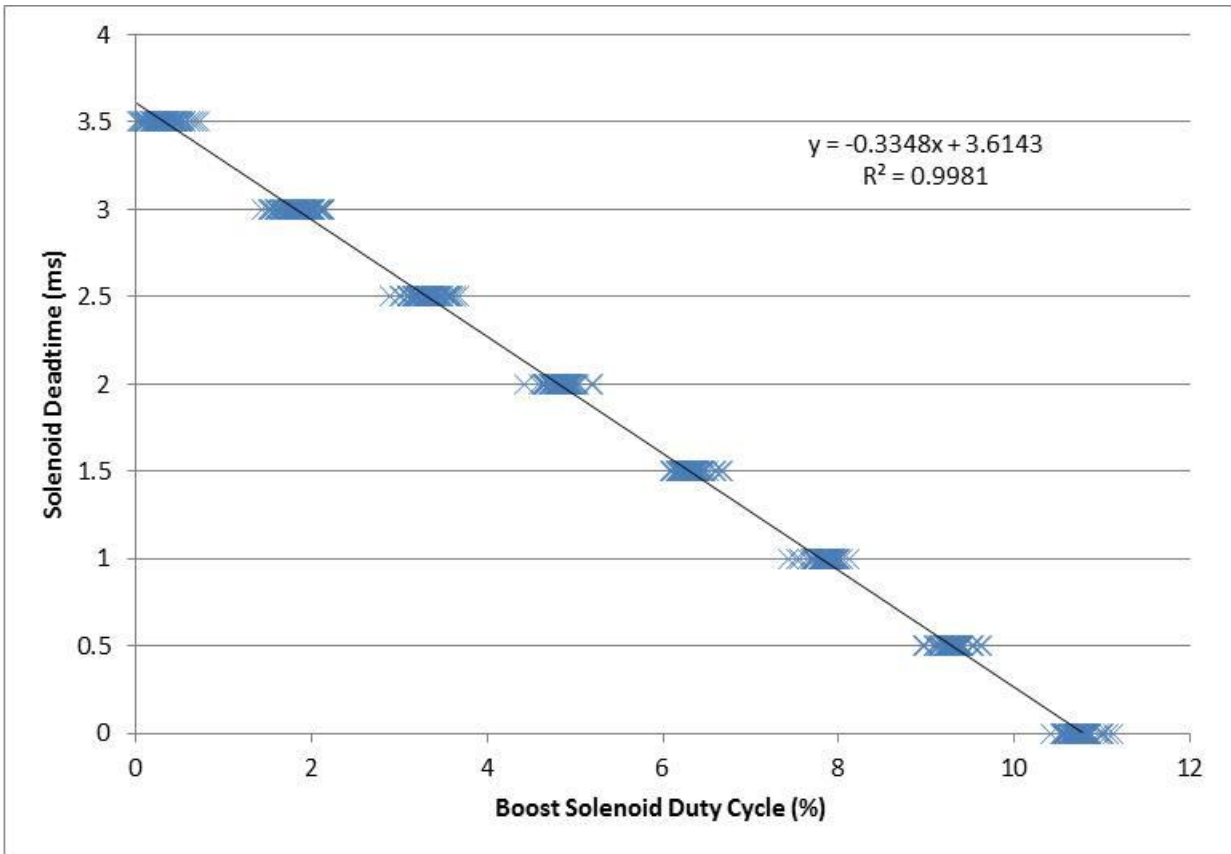

8.4 HOLLEY COMPONENTS

PN 557-200 – Holley 3 Port Solenoid

PN 554-102 – Holley 100 PSI Stainless Steel Pressure Transducer

PN 538-13 – Holley 2 Bar MAP Sensor

PN 554-107 – Holley 3 Bar MAP Sensor

PN 554-108 – Holley 5 Bar MAP Sensor (Stainless Steel 1/8 NPT)

**Holley® Performance Products
1801 Russellville Road
Bowling Green, KY 42101**

**1-270-781-9741
1-866-GOHOLLEY
www.holley.com**

© 2012 Holley Performance Products, Inc. All rights reserved.

199R10628

Date: 11-7-12