



# Holley EFI Pro Dash

## User Manual



# CONTENTS

Specifications .....	5
General .....	5
Mounting .....	6
Connections .....	7
Main Connector .....	7
CAN Extension Harness .....	9
USB .....	9
GPS Antenna .....	10
Cleaning .....	10
Using the Dash .....	10
Touchscreen Basics .....	10
Dashboard .....	10
Main Menu .....	10
Configuration .....	12
Dashboard .....	17
Data Log .....	17
Utilities .....	17
Preconfigured Layouts .....	17
Customizing Your Layout .....	19
Modifying Channels on a Preconfigured Layout .....	19
Import/Export .....	19
Starting from a Blank Layout .....	19
Changing the Background .....	20
Adding Gauges .....	20
Gauge Types .....	21
Gauge Type Examples .....	23
Customizing the Gauge .....	24
Moving a Gauge .....	34
Adding Labels .....	34
Adding Switches .....	35
Saving Your Layout .....	37
Exporting / Importing Layouts .....	37

Importing Layouts.....	37
Start-up Gauge Layout.....	37
Data Log Record and Playback .....	37
Local Data Record .....	37
Data Log Playback.....	38
USB Flash Drive Removal .....	38
Utilities Menu .....	38
Global Config.....	39
Downloading the Current EFI Configuration.....	39
Uploading a New EFI Configuration.....	39
Deleting EFI configuration files .....	39
File Utilities .....	39
Backup/Restore .....	40
Security Settings.....	40
Default Password .....	40
EFI Tuning .....	42
Menu Organization.....	42
Using the Tuning Menu .....	42
Enable/Disable Toggle .....	42
Numeric Editor.....	43
Pull-Down/List .....	43
Graph Editor.....	44
Table Editor.....	45
User Customizable Menus .....	46
Cleaning.....	46
Appendix A.....	47
List of EFI Monitored Values .....	47
Appendix B.....	49
nismo blue .....	49
blue 1 .....	49
DP race 1.....	50
GF race 1.....	50
Appendix C .....	51

## **ATTENTION!**

THE USB FLASH DRIVE INCLUDED WITH YOUR DIGITAL DASH CONTAINS A DETAILED USER MANUAL. ONE MAY ALSO BE FOUND ONLINE AT [www.holley.com](http://www.holley.com).

## Introduction

The Holley EFI Pro Dash is customizable with a variety of gauge and indicator screens that can be programmed to display any parameter you need from a Holley EFI system. This quick start guide will get you up and running with your new dash. A detailed User Manual can be found on the USB flash drive included with your product.

## Package Contents



## Specifications

### General

- Weather-proof aluminum housing engineered to withstand harsh racing environments
- 12.3" Low Glare, High Brightness, High Contrast, Full Color Touchscreen
- 1280 x 480 Resolution
- Operating voltage 8V - 20V
- Auto Brightness
- Plug and Play connection with all Holley EFI systems via CAN bus
- Completely customizable display of all EFI parameters including every user configured input and output
- Multiple gauge and indicator types with limitless customization options
- Quickly toggle between two or more active screens (tune, warm-up, race, drive, etc.)
- Virtual switch panel
- User defined channel alarms

- Configurable progressive shift lights and light bar
- On screen playback of EFI data logs
- Download and save Holley EFI data logs to external USB memory stick
- Expandable internal storage on micro SD card
- Flexible mounting options
- Support for future USB devices
- Upgradable with future software/firmware enhancements
- Multiple units can be used simultaneously on a Holley EFI system for larger dashboards

## Mounting

There are basically two ways to mount the dash, "surface" and "flush" mount. The product has six, 1/4-28 tapped mounting holes to allow the user to "surface" mount the enclosure (mount to a flat surface or bracket). Included with the contents of this kit is a separate template with a 1:1 layout of hole locations required for the 1/4-28 holes as well as other access holes needed.

There is a cut line on the template that allows the user to recess the product to facilitate a "flush" mounting option which recesses the unit, please be aware that brackets to support the back of the dash will need to be fabricated.

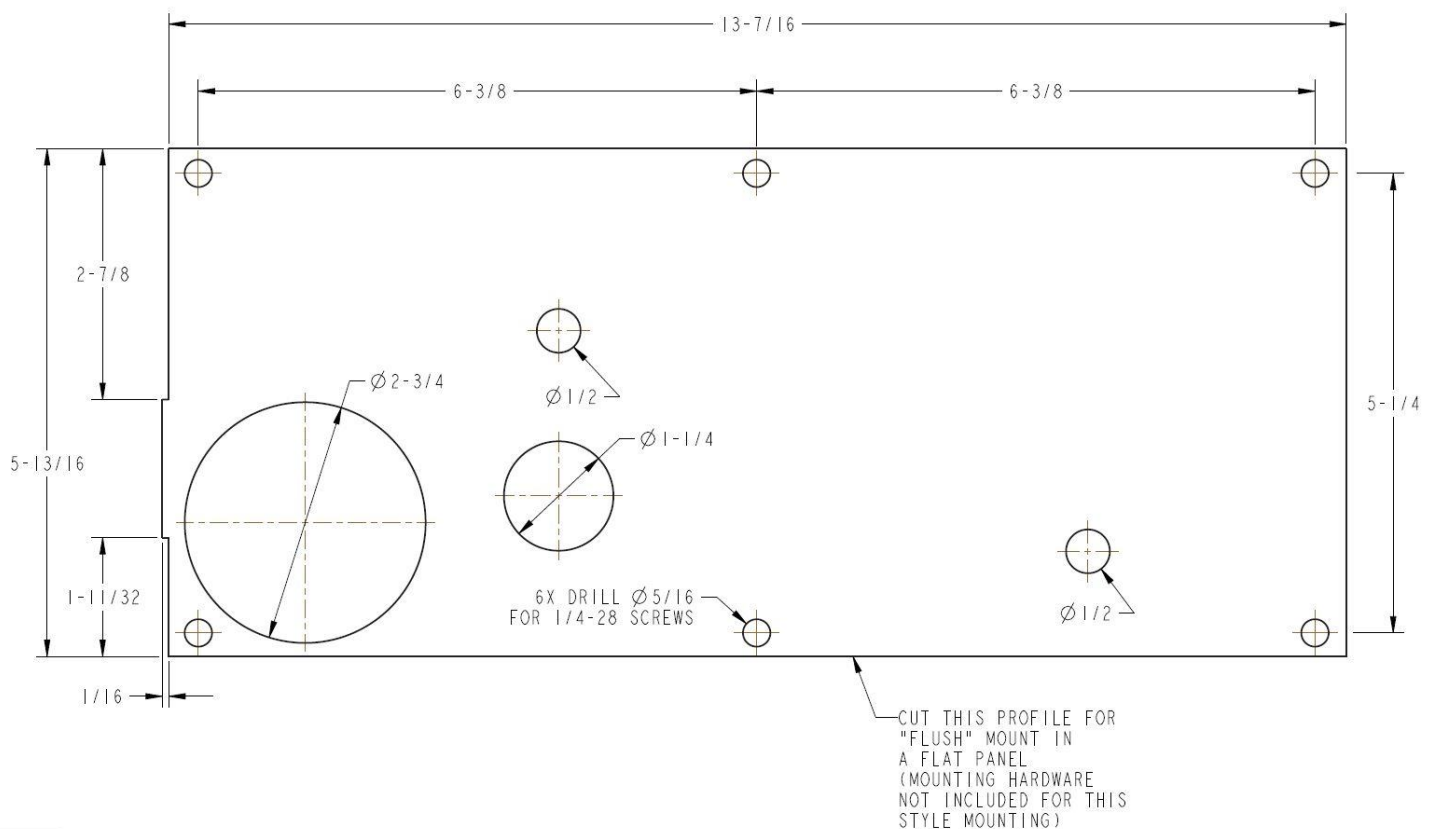



## Connections

### Main Connector

A 34 pin CAN/power harness supplied with the pro-dash and is used to for power, communications and I/O.

The following are the required connections:

Loose Black – Connect to a “clean” ground source. Don’t ground to poor sources such as sheet metal, or a ground point that does not have solid connectivity back to the battery.

Loose White – Connect to a “clean” switched battery power source

Loose Red – Connect to a “clean” continuous battery power source

“Clean” = a connection that does not share the same connections as “dirty” sources such as coils, a starter, solenoids, fans, etc., that have a lot of electrical noise or solenoid fly-back voltage.

CAN - Connect the harness from the CAN connector on the vehicles EFI main harness to the digital dash using the supplied male/female 4' CAN/Power extension. Place the supplied terminator into the empty CAN connector. The terminator must be used at the end of the CAN cable.

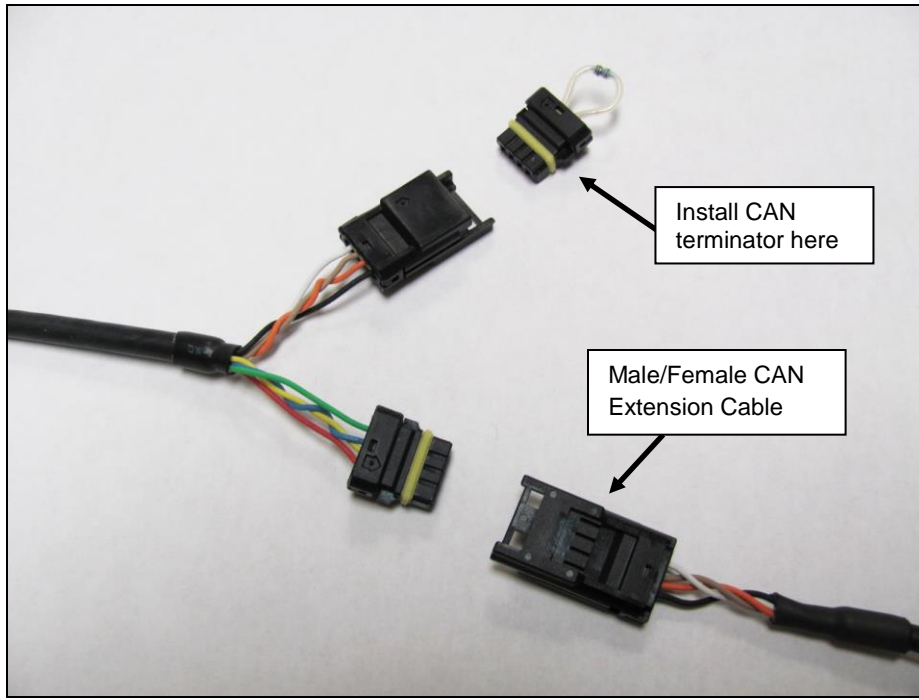

Holley EFI main harnesses use two types of CAN connectors. Earlier harnesses use a 2 pin metripak connector. The kit includes an adapter to go from this to the 4' extension harness (note the white power and black ground wires are NOT needed for the Pro Dash, but need to be connected if other CAN devices require it for their power supply). Later harnesses plug directly into the 4' extension harness.



Old Style CAN Adapter

The CAN harness attached to the dash includes both male and female CAN connectors. These connectors are wired in parallel to allow daisy chaining of multiple devices on the CAN bus.

Note that the Pro Dash does not use the CAN cabling to supply power and ground for it, unlike some other Holley EFI CAN devices, nor does the Pro Dash supply power to the CAN cabling, which is provided by the EFI harness.

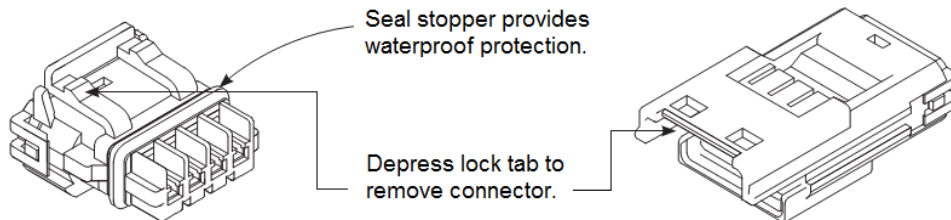

**Pro Dash CAN Cable Description**

Pin	Function	Description
1	+12V	Power (pass through between connectors, not used for Pro Dash)
2	CAN1H	CAN_H Holley EFI communications
3	CAN1L	CAN_L Holley EFI communications
4	GND	Ground (pass through between connectors, not used for Pro Dash)



## CAN Extension Harness

The dash is supplied with a 4' CAN extension harness. Holley also offers the following replacement harnesses:

**558-451** – 1 foot

**558-452** – 4 feet

**558-453** – 8 feet

**558-454** – 12 feet

Additional wires can be installed to use additional functions in the pro-dash. Consult the connector diagram and main user manual for more information.

### VIEW FROM REAR OF DASH CONNECTOR

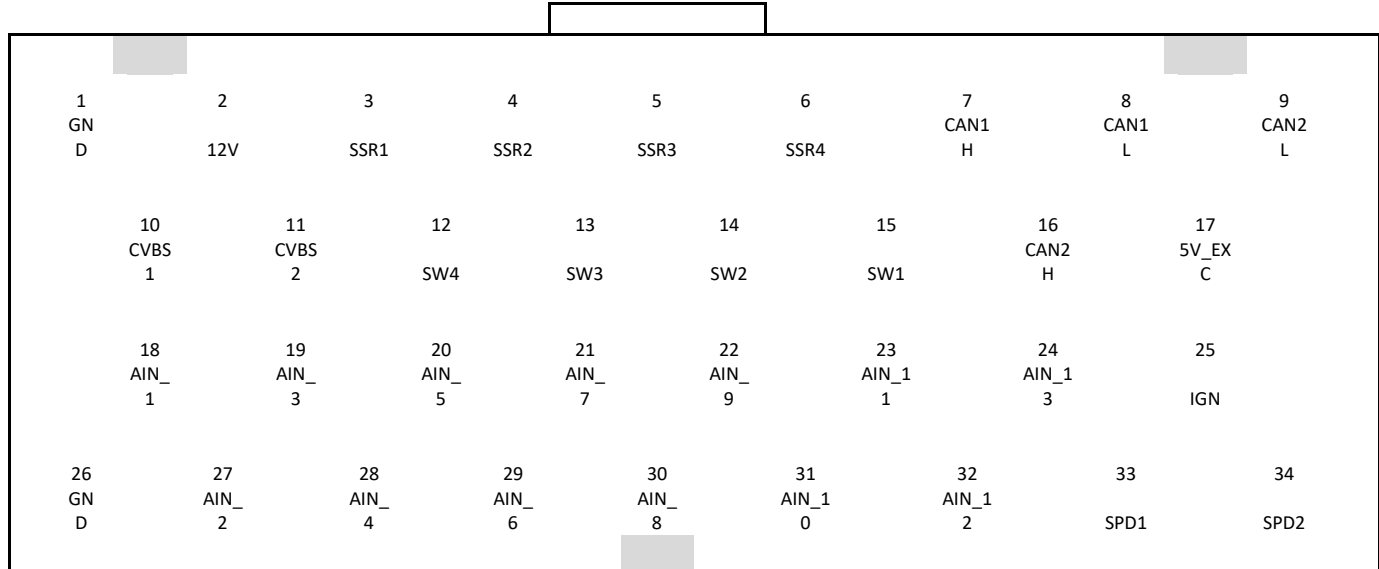

#### Notes:

1. The 12V main power input (pin 2) also provides backup for the internal clock and GPS
2. IGN (pin 25) needs to be connected to 12V to turn on the unit (low current input)
3. SSR1-SSR4 are low-side solid state relays, 1.5 Amp max
4. 5V\_EXC is used to power sensors, 450mA max
5. CVBS inputs are reserved for future use

The unit will draw approximately 5 mA in standby to maintain its real time clock and GPS information for quicker acquisition.

## USB

The unit has two standard USB type C locking receptacles (USB 2.0). Connect the supplied locking cable to the USB port on the back of the unit and tighten the thumbscrews.

This cable provides a type 'A' receptacle that can accept USB flash drives for saving data logs, uploading gauge screen layouts, background images, or firmware updates. You may also use these to connect to a USB mouse or keyboard if you do not want to use the integrated touchscreen for configuration.

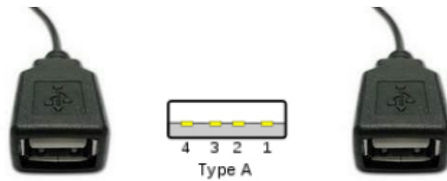

## GPS Antenna

Install the GPS antenna where it has clear view of the sky to the horizon for best reception. The antenna comes with a built-in magnet and can also be permanently mounted. For racing applications, it is recommended that the antenna be permanently mounted using the included double-sided VHB tape.

Connect the SMA connector to the GPS antenna connector on the back of the unit. Do not overtighten the connector, 3-5 in lbs max.

## Cleaning

If screen needs cleaning, use the supplied microfiber cleaning cloth. Do not use harsh chemical cleaners on the touch screen display.

## Using the Dash

### Touchscreen Basics

The Pro Dash has a capacitive touch screen display similar to many cell phones. A stylus is not required to use the screen. If a stylus is desired, get one designed for a capacitive touch screen (same as used for most cell phones). While thick gloves may not work properly, some racing gloves are available with integrated finger pads that work with touch screens. The touch screen is used for configuration and EFI tuning.

There are four switch inputs that are designed that can be used with pushbutton switches to select functions on the pro dash while driving.

### Dashboard

The dashboard will appear when you power on your Dash. There are several screen layouts that can be selected. Press anywhere on the display to bring up the navigational buttons, then choose 'Next' or 'Prev' to cycle through the screen layouts.

### Main Menu

Pressing anywhere on a gauge screen will bring up the navigational buttons. To access the main menu choose 'Menu' in the upper right corner of the screen.



The main menu can be reached by touching anywhere on the dashboard screen to bring up the on screen buttons, then press on 'Menu' in the upper right corner.

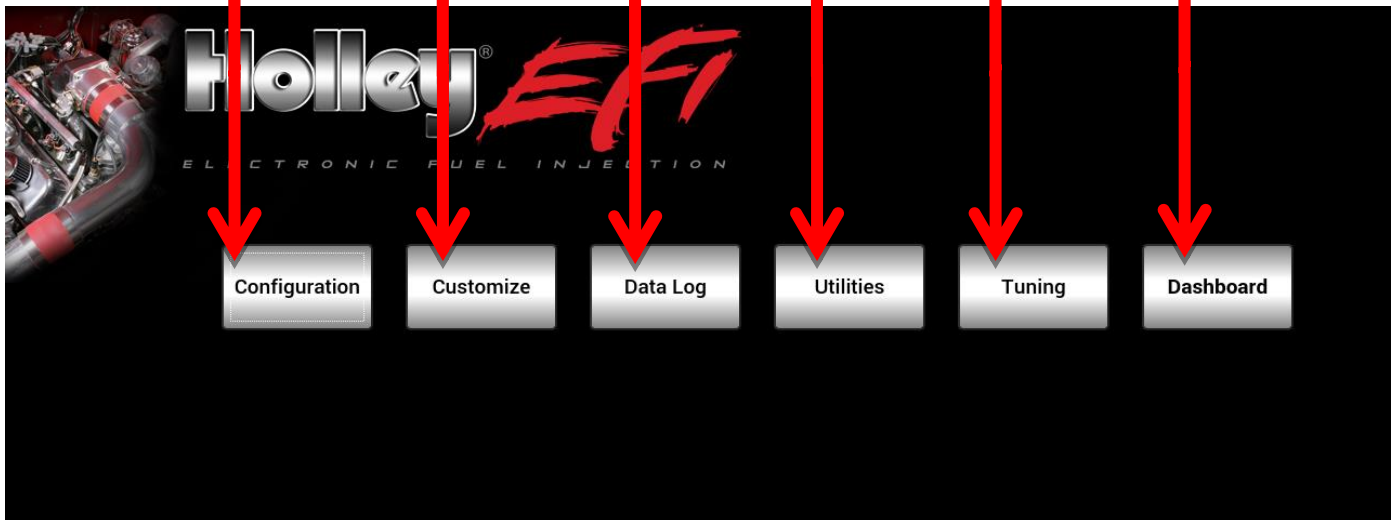
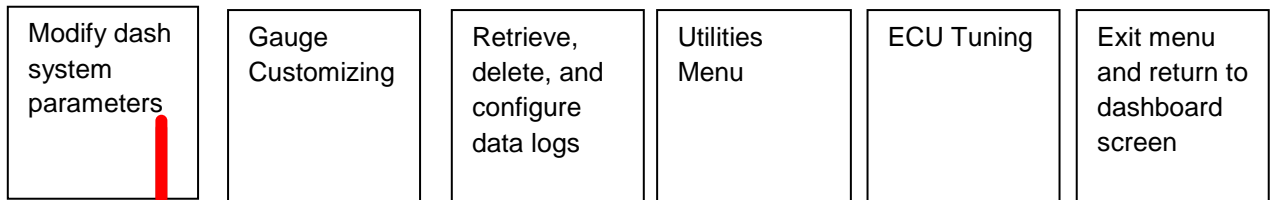

## Configuration

The configuration screen allows you to change the display brightness, modify the number of gauge display layouts (screens), update firmware, and calibrate the touchscreen if required.

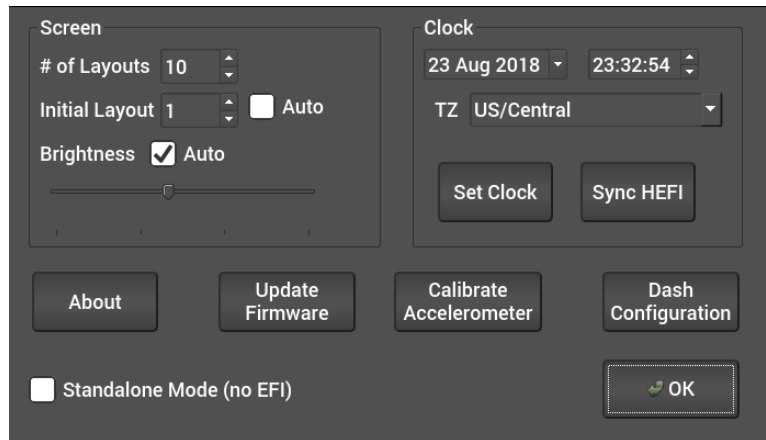

### **Standalone vs EFI Connected Mode**

The Dash has two main modes of operation, standalone and EFI-connected. If you have a Holley EFI installed in your vehicle, ensure that the standalone mode is unchecked in the configuration menu.

If you are using the Pro Dash without a Holley EFI, select Standalone mode. The EFI specific Datalog and Tuning buttons will no longer be shown in this mode.

### **Layouts**

You may choose the number of layouts or gauge display screens that are configured. An example would be 4 screens, representing tuning, warm up, race, and street.

The Dash will use the last saved layout as the preferred screen to display at power on.

### **Initial Layout**

If Auto is unchecked, the initial power-on layout can be chosen from one of the numbered layout screens.

If Auto is checked, the power-on layout defaults to the last displayed layout when power was removed.

### **Auto Brightness**

The Dash has an ambient light sensor at the lower left corner of the display. This sensor is used to set the backlight brightness when auto brightness is enabled. If this sensor is covered, the auto brightness feature will not function.

Press on the “Auto” beside brightness to enable the auto-brightness function. For manual brightness control, use the slider to adjust the screen brightness.

## Clock

The Dash has an internal real-time clock that can be adjusted using this screen. When the GPS is connected, the clock will be automatically set (unless disabled in the dash configuration). Make sure the time zone is set correctly.

The clock will maintain time when powered off and voltage is present on the main power input (pin 2).

## About

This screen contains firmware and software version information along with the CAN id for the Pro Dash. When connected with a Holley EFI it will show details of the connected EFI.

## Update Firmware

New or additional features developed by Holley can be added to the Digital Dash by updating firmware. These updated firmware files can be obtained by contacting tech service (270-781-9741 or 1-866-464-6553) or they may be downloaded from our website ([https://www.holley.com/support/resources/#Fuel\\_Injection](https://www.holley.com/support/resources/#Fuel_Injection)).

To perform a firmware update, follow these steps:

1. Extract the contents of the firmware .zip file onto a USB memory stick (unzip files and put on USB memory stick)
2. Connect the USB memory stick to one of the USB cables on the Digital Dash.
3. Select 'Update Firmware' from the Configuration menu and follow the on screen prompts. The firmware will automatically update.
4. Verify the version number using the About button after turning the dash off and on again

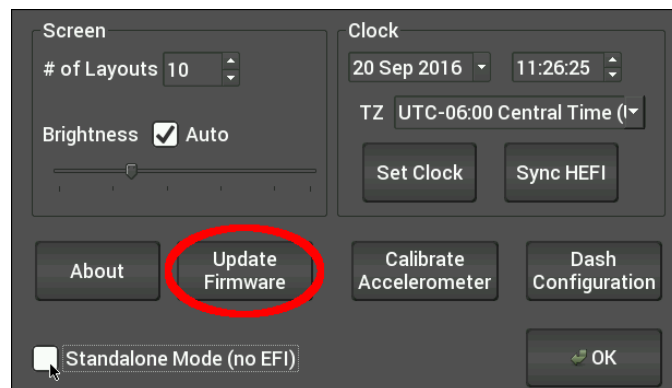

## Dash Configuration

This option configures the local dash settings.

## Local I/O Tab

Configures the inputs and outputs that are available on the dash. The "Pin" refers to the pin number of the 34 Pin Dash connector.

- RPM will be used to display on tachometer gauges. This **MUST** be connected to a 12v square wave. It can **NOT** be connected directly to the coil or the dash will be damaged!
- Speed is calculated using the vehicle wheel diameter, rear end ratio and pulses/rev (in MPH)
- Frequency is displayed in Hertz (pules per second)
- Holley CTS is preconfigured for **P/N 534-10**

- Holley MAT is preconfigured for **P/N 534-20**
- 100 PSI Oil Pressure is preconfigured for **P/N 554-102**
- Custom 5v can be configured for any sensor that outputs a 0-5v signal. Holley sells a variety of 0-5v sensors for monitoring a wide range of data.
- Custom CTS is for custom thermistors
- Custom MAT is for custom thermistors
- Resistance based Fuel level sending units should use IO7 Pin 21
- SSR.# are ground switched outputs suitable for use in triggering relays and devices that draw below 1.5 Amps each.
- Switch to Ground Input is a ground switched input to the dash. The dash provides an internal pullup current.
- Switch to 12v Input is a 12v switched input to the dash (example: turn signal indicators)

Name	Pin	SSR Out (2 Amp)	Custom 5V Input	Switch to Ground Input	Switch to 12v Input	100 PSI Oil	Digital In	Engine RPM	RPM	Vehicle Speed	Frequency	Holley CTS	Holley MAT	Custom CTS	Custom MAT	Custom Ohms
io.1	18		x													
io.10	31		x	x	x		x									
io.11	23		x	x	x	x	x	x	x	x	x					
io.12	32		x	x	x	x	x	x	x	x	x					
io.13	24		x	x	x	x	x									
io.2	27		x													
io.3	19		x	x	x		x									
io.4	28		x									x	x	x	x	x
io.5	20		x									x	x	x	x	x
io.6	29		x									x	x	x	x	x
io.7	21		x									x	x	x	x	x
io.8	30		x	x	x		x									
io.9	22		x	x	x		x									
rpm.1	33							x	x	x	x					
rpm.2	34							x	x	x	x					
ssr.1	3	x														
ssr.2	4	x														
ssr.3	5	x														
ssr.4	6	x														
sw.1	15			x												
sw.2	14			x												
sw.3	13			x												
sw.4	12			x												
GROUND	1															
Battery 12v	2															
Can 1 Hi	7															
Can 1 Lo	8															
Can 2 Lo	9															
future	10															
future	11															
Can 2 Hi	16															
5v Output	17															
Sensor Ground	26															
12v Ignition	25															

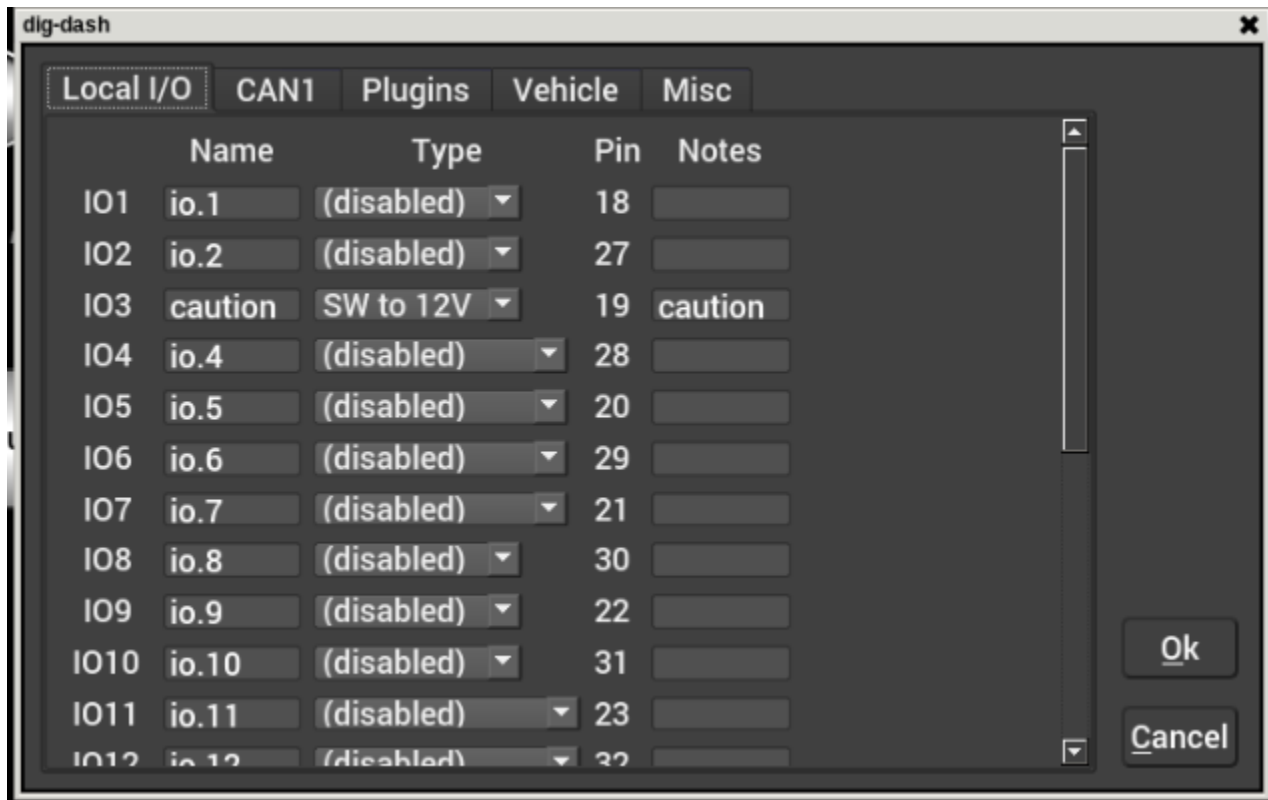

### **Switch to Ground (SW to GND) Special Functions**

The *switch to ground* inputs can be used to scroll screens on the dash. These can be wired to buttons on a steering wheel or other easily accessible location.

To use, enter the desired keyword in the Name field as shown in the table. You must include the square brackets, case is not sensitive.

<b>Keyword (Name field)</b>	<b>Function</b>
[next]	Display the next screen layout
[prev]	Display the previous screen layout

The dash will provide a low current pullup source on each input designated as SW to GND.

### **CAN Tab**

Configures CAN-connected devices such as the Holley 553-107 LED Light Bar.

## Vehicle Tab

Contains settings that control the input channel that drives the internal odometer and local RPM and speed calculations. The odometer can source can be selected from EFI Transmission Speed, an EFI input, local Dash speed input or from the internal GPS receiver.

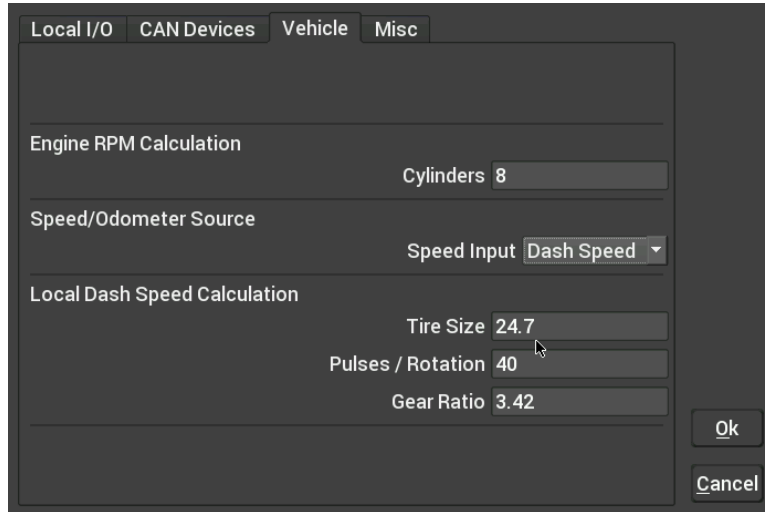

**Trans Speed:** Use with supported transmission. Requires that you have a properly setup transmission ICF in your Dominator ECU.

**GPS Speed:** Use this setting with the internal GPS. No additional setup is required.

**Dash Speed:** Use this setting when you want the speedometer and odometer to read from a speed sensor going directly to the dash on inputs SPD1, SPD2, IO11, or IO12. The corresponding channel needs to be set to the "Vehicle Speed" type. This is the only setting that requires you to fill out the Local Dash Speed Calculation area on the Holley Pro Dash. Note that only one of the dash input channels can be set to "Vehicle Speed".

**ECU Input:** Use with a custom speed sensor input from the I/O section of your Holley ECU. The ECU input must be named "speed" and the units set to miles/hour for the odometer to report distance accurately.

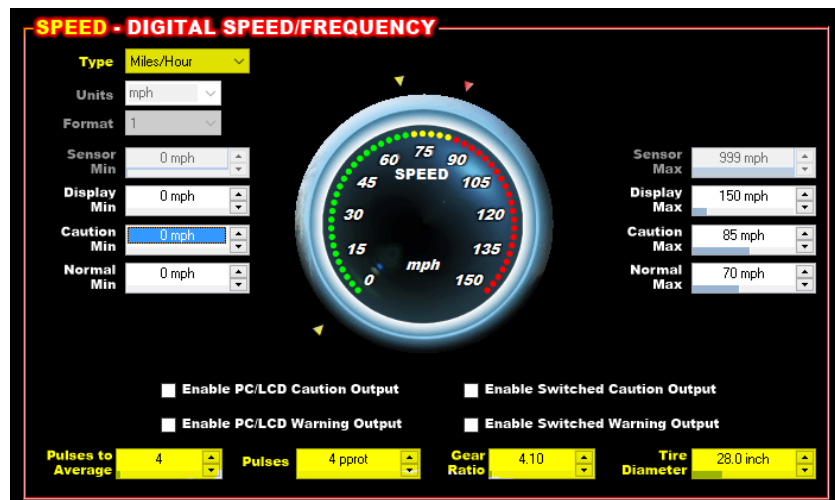



## Misc Tab

The touch screen is calibrated at the factory and should not require any adjustments. If the touch screen drifts due to environmental factors it can be re-calibrated from this menu.

## Dashboard

This selection returns you to the operational dash layout.

## Data Log

The Holley EFI Pro Dash allows you to retrieve, delete and configure data logging with the attached HEFI. Data logs can be saved internally or to a USB memory stick for viewing on a computer.

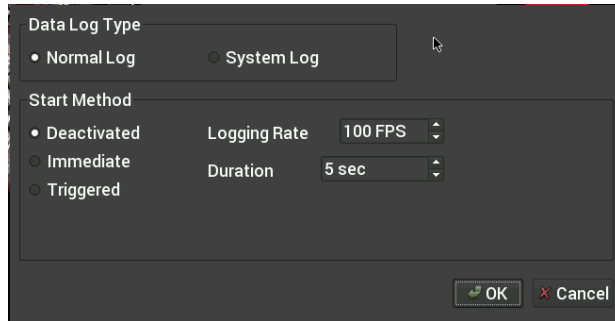
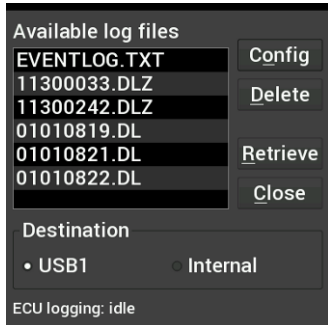

## Utilities

The utilities menu is described later on in the manual.

## Preconfigured Layouts

The Holley EFI Pro Dash comes standard with ten preconfigured gauge layouts. The first ten of these layouts are active by default. If a smaller or larger number of layouts are desired, select 'Configuration' from the Main Menu. The minimum number of layouts is two and the maximum is ten. These layouts are also stored on the dash memory.

Below are examples of the ten preconfigured layouts:

# Preconfigured Gauge Screens



Layout 1



Layout 2



Layout 3

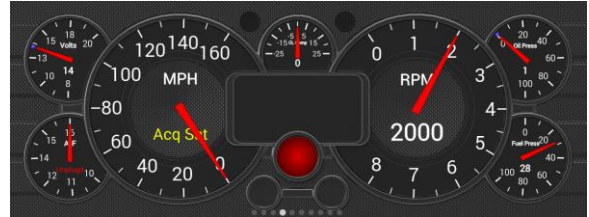

Layout 4



Layout 5



Layout 6



Layout 7



Layout 8

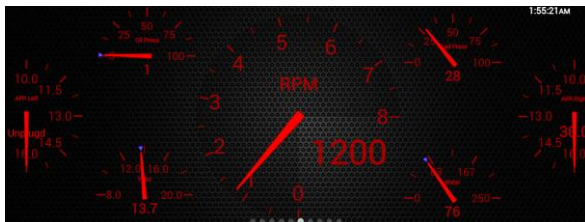

Layout 9

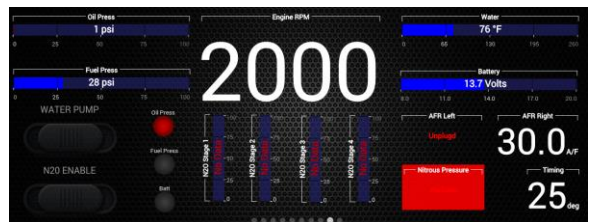

Layout 10

## Customizing Your Layout

Choosing 'Customize' from the Main Menu enables the gauge customization mode. Entering this mode will allow any of the preconfigured layouts to be modified, or one may be built from scratch.

Gauges can have independent warnings and ranges set, even if they are connected to the same monitored value.

To exit customize mode, touch on any background area (not on a gauge) to bring up the context menu and select "Save" or "Discard changes".

## Modifying Channels on a Preconfigured Layout

Any gauge channel can be changed to meet user needs. To do this, touch the gauge to modify and press 'Customize'. At the top right corner of the customize gauge menu is a button that will allow the user to redefine the channel being displayed. For instance, fuel pressure on Layout 10 could be changed to display Boost.

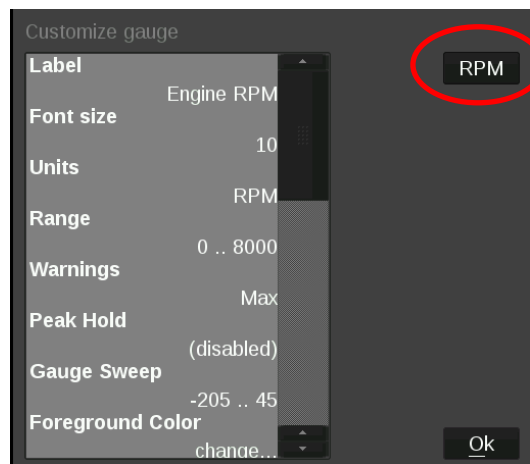

**NOTE: Only the gauge value being display will be updated, the user MUST manually change Labels, Units, Range, Warnings etc. with proper values as these will NOT be updated automatically! Refer to the 'Customizing Your Layout' Section of this manual for instructions on gauge customization.**

## Import/Export

The import function will load any saved gauge layout (.ini file) to the active screen. The export function will allow any gauge layout to be saved internally or to a USB Memory Stick. Preconfigured layout examples and filenames are outlined later in this manual.

## Starting from a Blank Layout

To begin building a custom layout from a blank screen, touch any bare area of the background.

Choose Layout > Clear

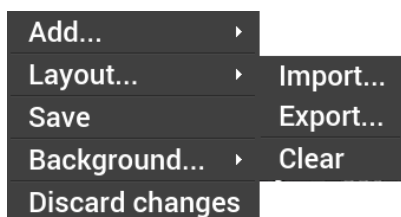

## Changing the Background

The Holley EFI Pro Dash comes preloaded with a variety of background images and gauge templates (see Appendix C). Users can also upload their own background image from a USB memory stick. Background images should be 1280x480 resolution, in .jpg or .png file format.

To change the background, touch an area of the background to bring up the customize menu and choose 'Background' | 'Change'.

A file directory listing will show available background images. To choose one from a USB drive, select 'USB' on the left side of the screen and that drive's files will then be shown. A preview of the background image is shown to the right as you select a filename. Choose a background filename, and press OK to replace the current background. The background image is copied to the internal memory of the Dash so the USB does not have to be present for that background to be used.

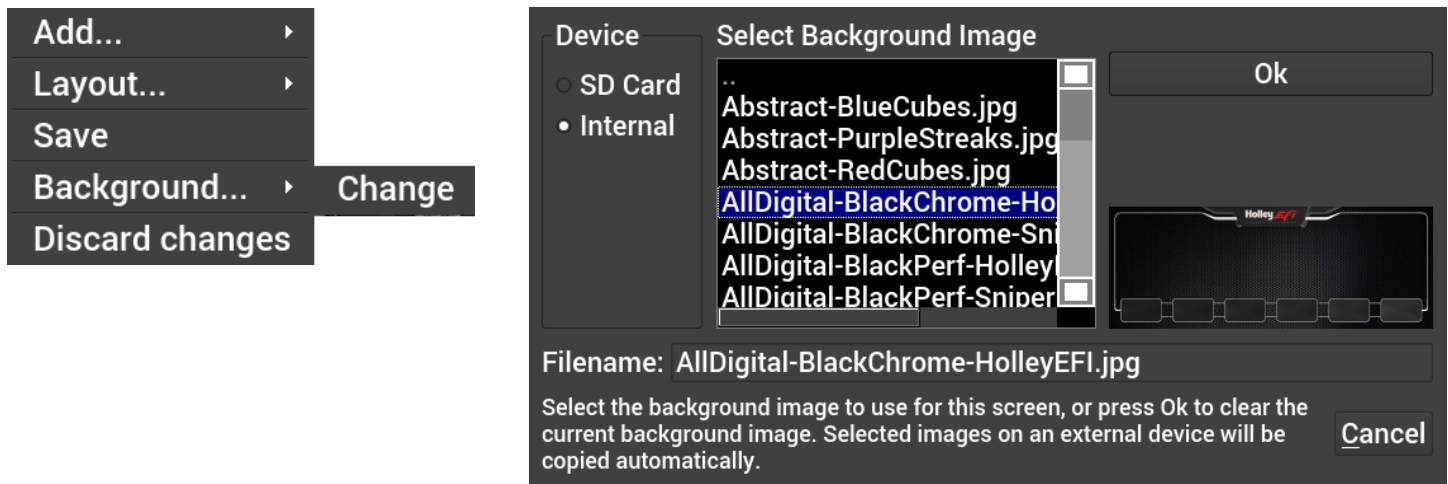

To remove the background from the current layout, press Ok without selecting a filename.

## Adding Gauges

Press on the display where you want a gauge to appear, then click Add > Gauge > Value to Monitor > Gauge Type. Once you have selected the gauge type you will be asked to select the value to monitor. Every available EFI channel including user configured inputs and outputs will be shown in this list (see Appendix A). Once the value is chosen the gauge will be placed on the screen.

1. Select 'Add'
2. Select 'Gauge'
3. Select a value to monitor from the list
4. Select the gauge type

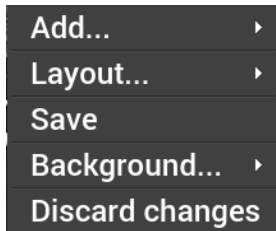

Step 1

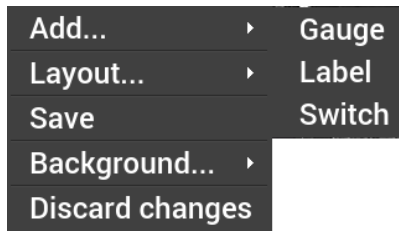

Step 2

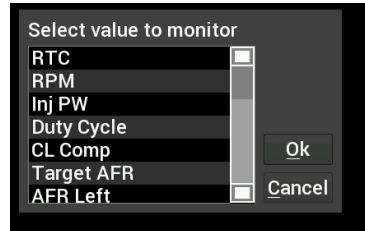

Step 3

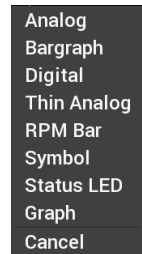

Step 4

## Gauge Types

See page 23 for pictures of all gauge types.

### **Analog**

Traditional style gauge with a sweeping needle. For flexibility, individual elements can be disabled (legend, values, border) to allow moving needles on a graphic gauge image background.

### **Bargraph**

Bargraph gauges can be oriented horizontally or vertically.

### **Digital Meter**

Numeric value readout

### **Thin Analog**

Round gauge with a sweeping bar instead of a needle.

### **AFR Meter**

The AFR meter is more of a lean/rich indicator. There is a green target that shows the current Target AFR that is programmed in the map. In closed loop, the gauge face will rotate so that the target AFR is pointing 'north' on the gauge. The needle and digital value shows the current AFR reading.

In this fashion, if the needle is pointing to the left the engine is running rich, and if the needle points to the right the engine is running lean.

The AFR meter option will only appear on AFR channels.

### **Symbol**

The symbol gauge type will change its color based on settings in the warnings section for this gauge. This can be used to display an automotive symbol warning light or normally hidden text that will be displayed when an alarm condition is reached.

### **Status LED**

The status LED illuminates when the monitored value reaches the programmable caution high or low values.

### **Graph**

The graph type show a plot of a monitored value.

### **RPM Bar**

The RPM bar consists of 10 LEDs, comprising three programmable ranges.

- The Green LEDs illuminate from the *minimum range* value to *High Warning* value.

- The Red LEDs illuminate in the *High Warning* through *High Alarm* values.
- The 5 Blue LEDs illuminate once *High Alarm* is exceeded.

A standard configuration for a 7000 RPM shift would be to set:

- Minimum range to 4000
- High Warning to 6500
- High Alarm to 7000 rpm

The color of each zone can be chosen by the user.

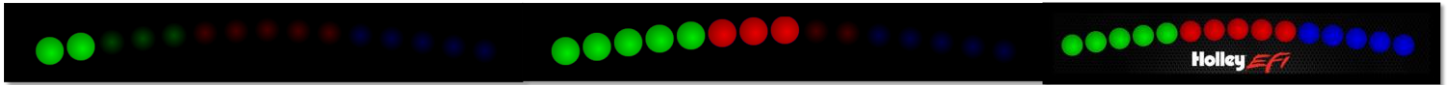

### ***RTC Channel***

RTC is a real time clock and can be configured as an analog or digital gauge.

# Gauge Type Examples



ANALOG

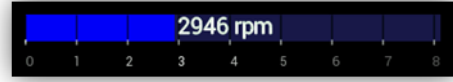

BARGRAPH



DIGITAL METER

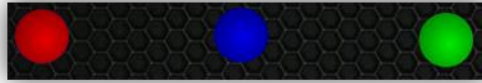

STATUS LEDS



RTC



AFR METER



THIN ANALOG

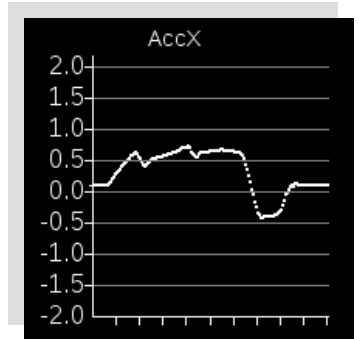

GRAPH



RPM BAR

## Customizing the Gauge

While in 'Customize' mode, touch the gauge you would like to modify and a menu will appear. To move the gauge select 'Move' (A) and drag the gauge to place it in the desired location. To customize the visual properties and warning indicators, select 'Customize' (B) from the pop up menu. In the scroll window you can see the parameters that are configurable.

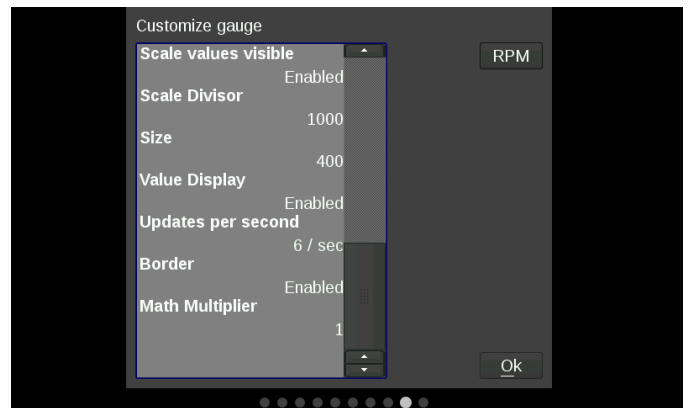
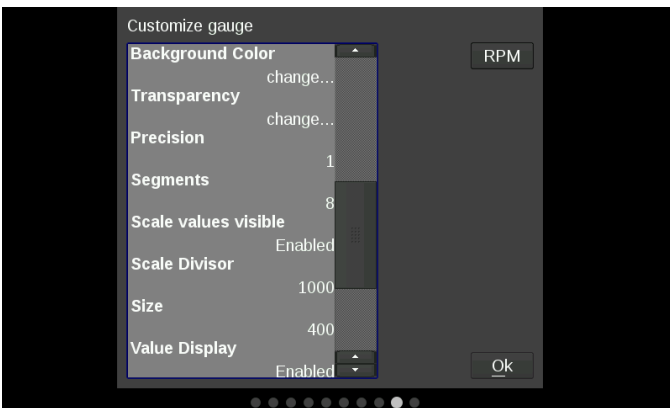
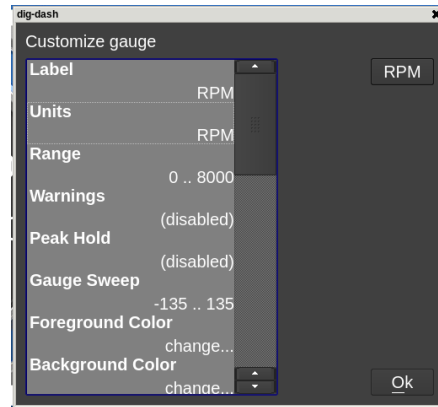
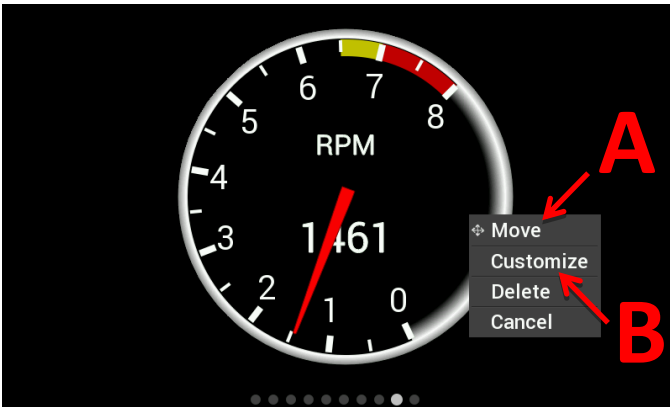

### Label

The Label is used to name the gauge. Use the 'Visible' check box to enable or disable it. To edit the label, select the text box and a full keyboard will appear. To use a symbol instead of text, touch the 'Sym' button. There are two Symbol keyboards, pressing the shift key will toggle between the two. When finished, press 'Ok'.

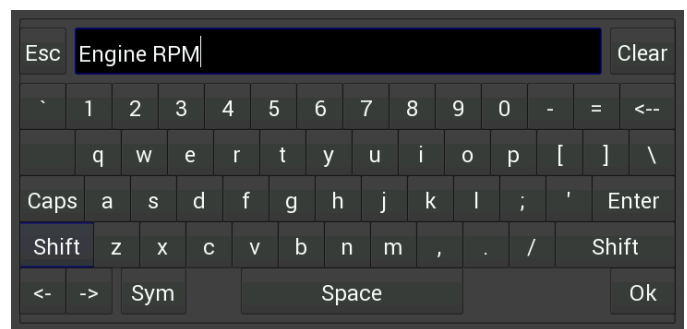
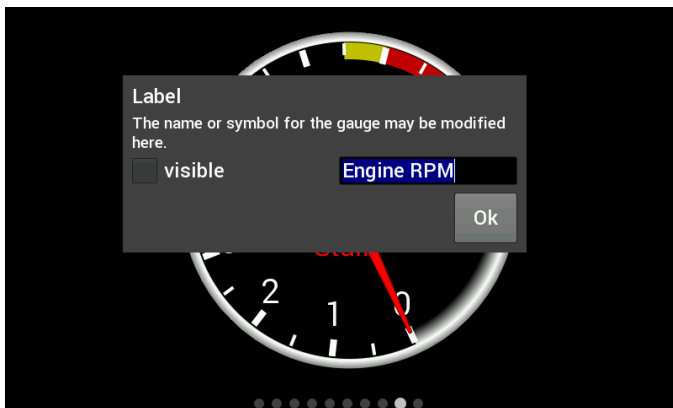



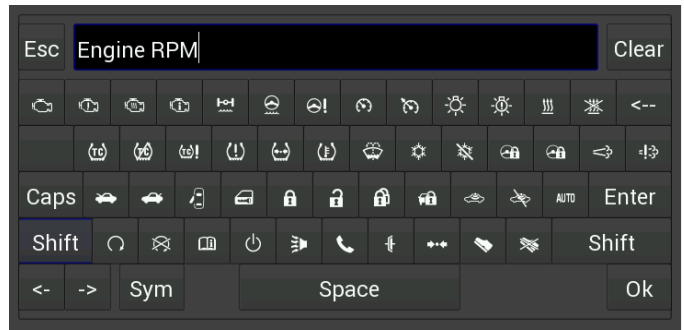
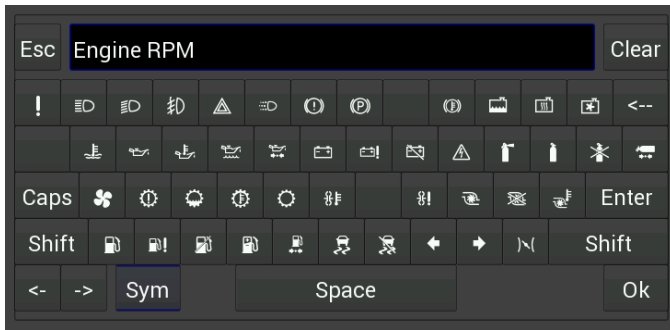

**Font Size**

This is used to adjust the font size of labels within the gauge. Touch inside the text box to bring up a number keypad. The top of the keypad will display the minimum and maximum text size values (in pixels). In this case, the minimum is 5 and maximum is 240.

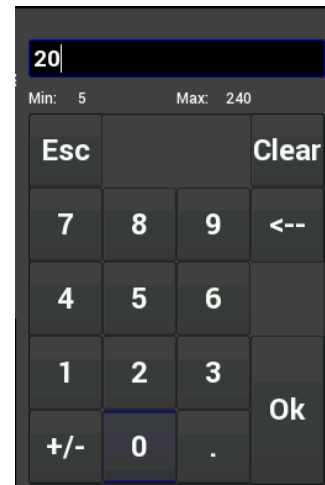
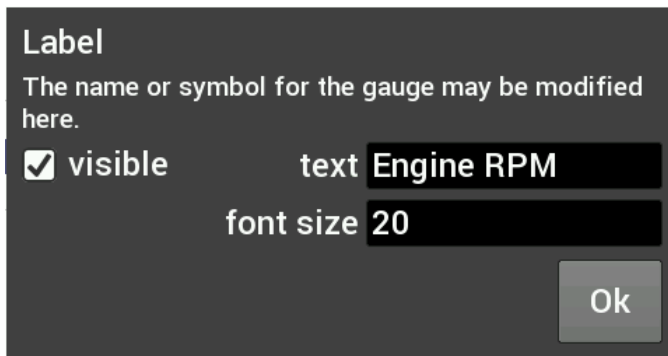

**Units**

The 'Units' label can be modified in the same fashion as the gauge label. To do this, touch inside the text box to bring up the keyboard. When finished, press 'Ok'.

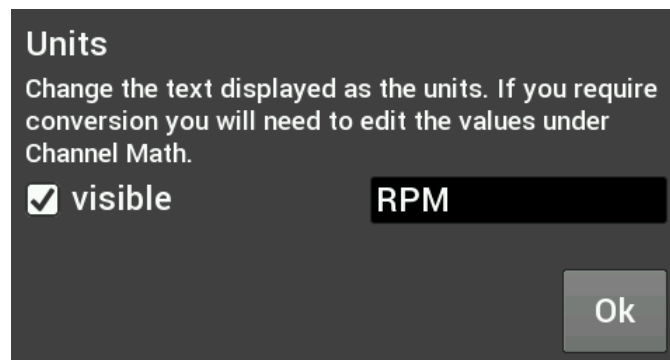

## Range

This will adjust the minimum and maximum display range of the gauge.

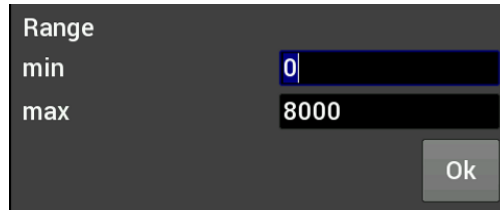

A dialog box titled "Range" with two input fields. The "min" field contains the value "0" and the "max" field contains the value "8000". An "Ok" button is located at the bottom right of the dialog.

## Warnings for Gauges

Configuring warnings will dictate when the gauge changes colors. When values reach the Low Warning or High Warning value, the gauge face will change to the color beneath that value. When the gauge value reaches Low Alarm or High Alarm, the gauge face will change to the corresponding color. You can click on the color bar beneath the values to change the corresponding color.

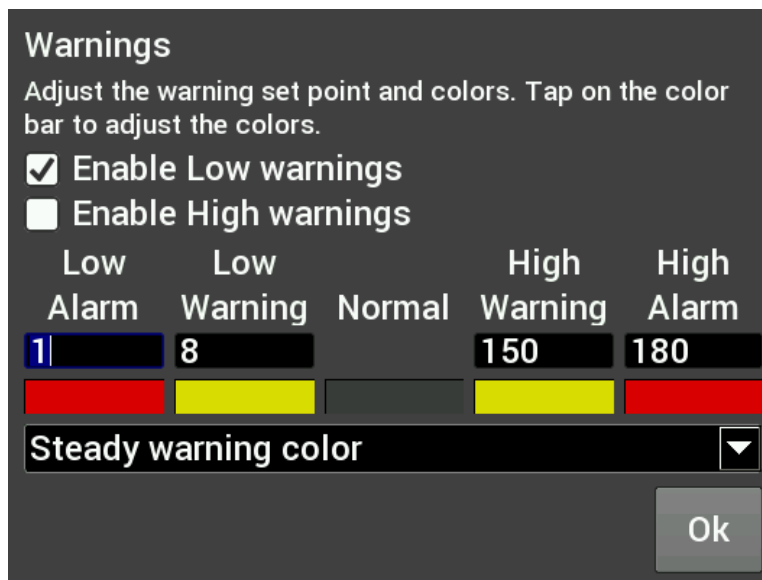

A dialog box titled "Warnings" with the following content:

- Adjust the warning set point and colors. Tap on the color bar to adjust the colors.
- Enable Low warnings
- Enable High warnings
- Low Alarm: 1 (color bar: red)
- Low Warning: 8 (color bar: yellow)
- Normal: (color bar: grey)
- High Warning: 150 (color bar: yellow)
- High Alarm: 180 (color bar: red)
- Steady warning color: (dropdown menu)
- Ok button

## Warnings for LED Status Lights or Symbols

In the case of LED Status Lights, the color of the LED is chosen by clicking on the color bar beneath the warning values. The corresponding enable must also be set. Figure A shows an example of a CTS setup, where the LED would change from blue, violet, green, yellow and red throughout its range of values.

Symbols are similar, which will change color based on its corresponding value channel. In this manner you can duplicate the function of lit symbols on your dashboard.

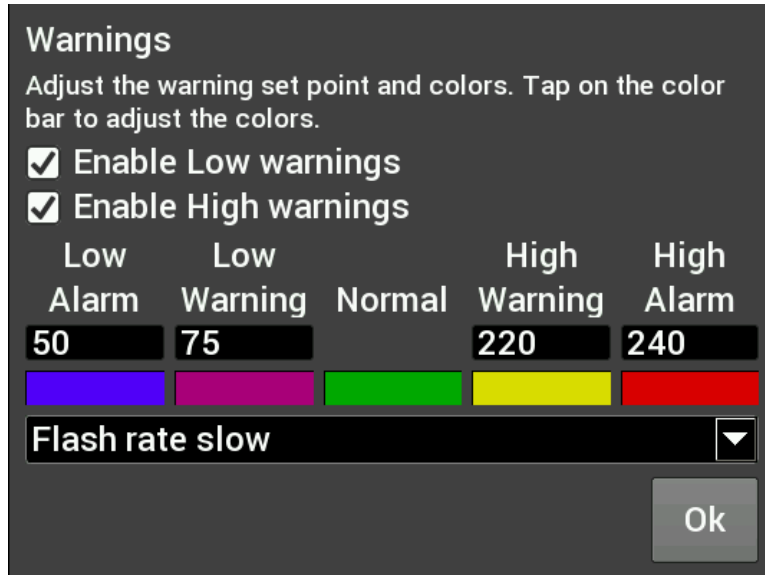

Figure A. CTS Warning Example

### Status LEDs for Switched Items (ON/OFF)

A status LED can be lit to show when an item is either on or off. To have an LED lit for when an item is turned on, configure per Figure B. To have an LED lit for when an item is turned off, configure per Figure C. The LED will be grey when in the normal state.

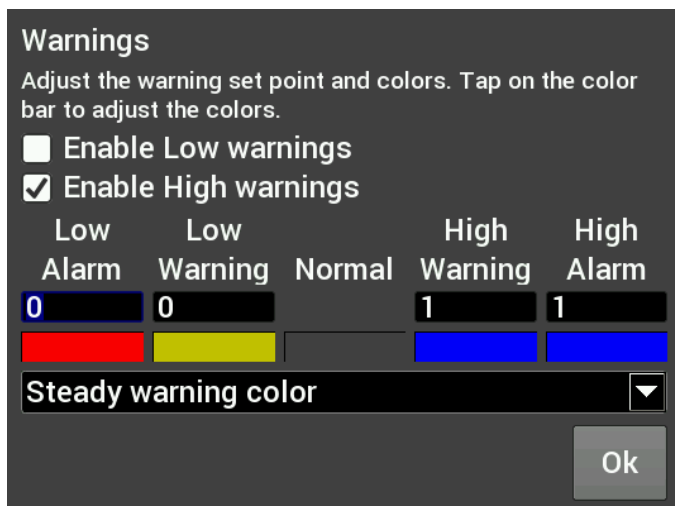

Figure B. Blue LED when output is ON

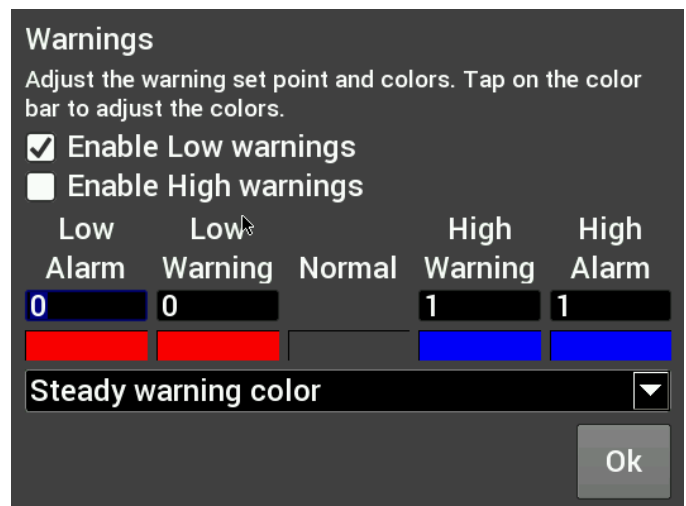

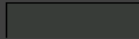



Figure C. Red LED when output is OFF

Full color configuration and Alpha control (transparency) can be used with Status LEDs. Touch the rectangular color bar below the value input box to change colors.

**Warnings**  
Adjust the warning set point and colors. Tap on the color bar to adjust the colors.

Enable Low warnings  
 Enable High warnings

Low Alarm	Low Warning	Normal	High Warning	High Alarm
-100	-100		100	100
				

Ok

Status LED Configuration

**Basic colors**

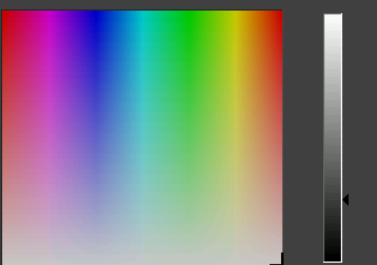
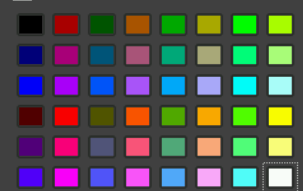

**Custom colors**



Add to Custom Colors

Hue: 0 Red: 63  
Sat: 0 Green: 63  
Val: 63 Blue: 63  
**Alpha channel: 255**

OK Cancel

Status LED Color Configuration



Alpha Channel example from left to right (75, 150, 255)

### Peak Hold

Enabling the Peak Hold features will place a marker at the highest and/or lowest value for quick viewing. This feature is similar to the traditional 'Tattletale' Tachometers. The minimum peak is shown with a blue triangle, and the maximum peak is a red triangle.

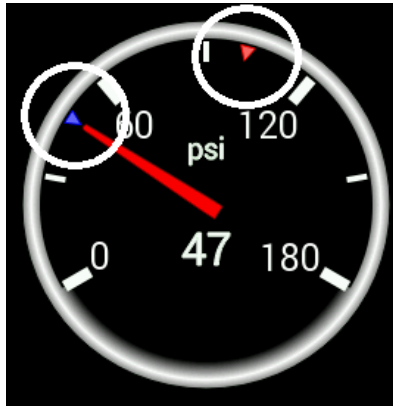

### Gauge Sweep

Users can configure the sweep angle of Analog and Thin Analog gauges. These values are in degrees. Positive values are in a clockwise direction and negative values are in a counter-clockwise direction. There are three buttons that will set the sweep to a standard 270 degree, 120 degree, or 90 degree gauge. View examples below.

0°	12 o'clock
30°	1 o'clock
60°	2 o'clock
90°	3 o'clock
180°	6 o'clock
270°	9 o'clock

0°	12 o'clock
-30°	11 o'clock
-60°	10 o'clock
-90°	9 o'clock
-180°	6 o'clock
-270°	3 o'clock

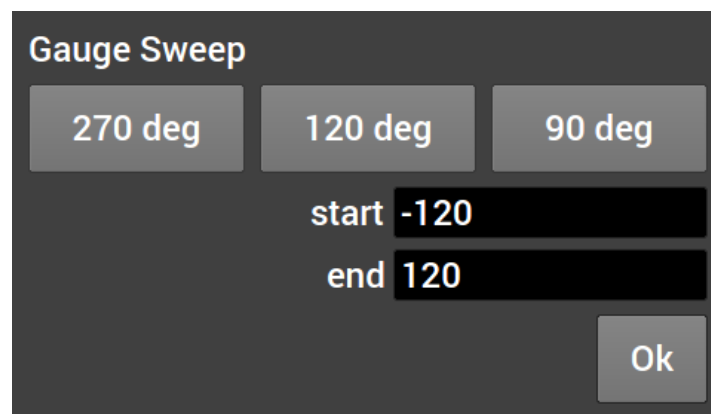

## Gauge Sweep Examples:



-120 Start / 120 End

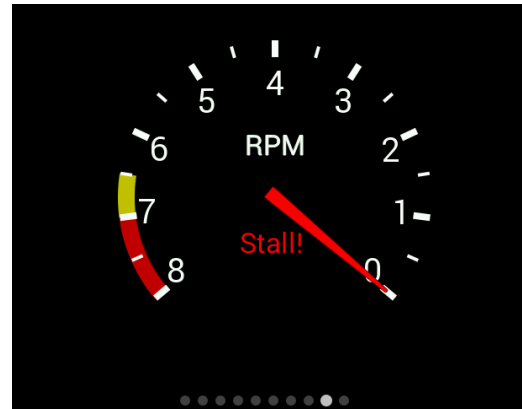

120 Start / -120 End

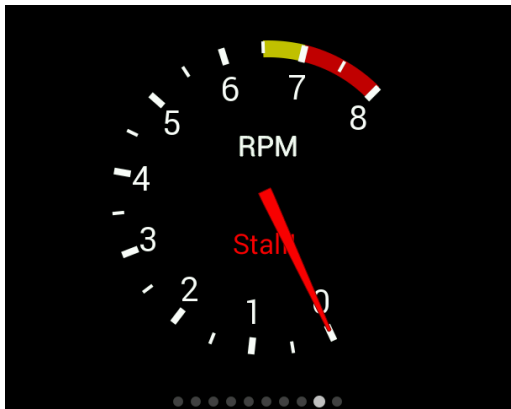

-205 Start / 45 End

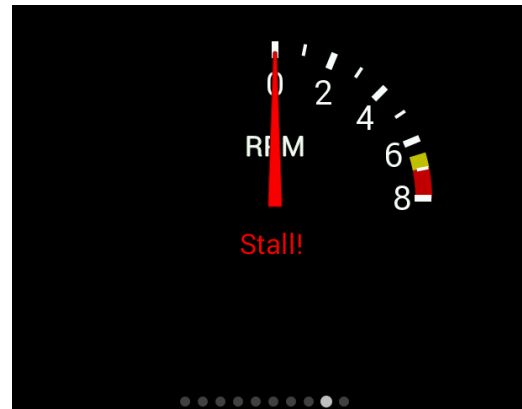

0 Start / 90 End

### Foreground Color

Changing the foreground color will modify the text, labels and values of a gauge. Use a stylus to drag the crosshair to the desired color. The rectangular box at the bottom of the screen will show a preview of what is being selected. Custom colors can be saved for future use by using the stylus to drag from the rectangular preview box and drop onto one of the custom color boxes at the bottom left of the screen. Choose 'Ok' when finished.

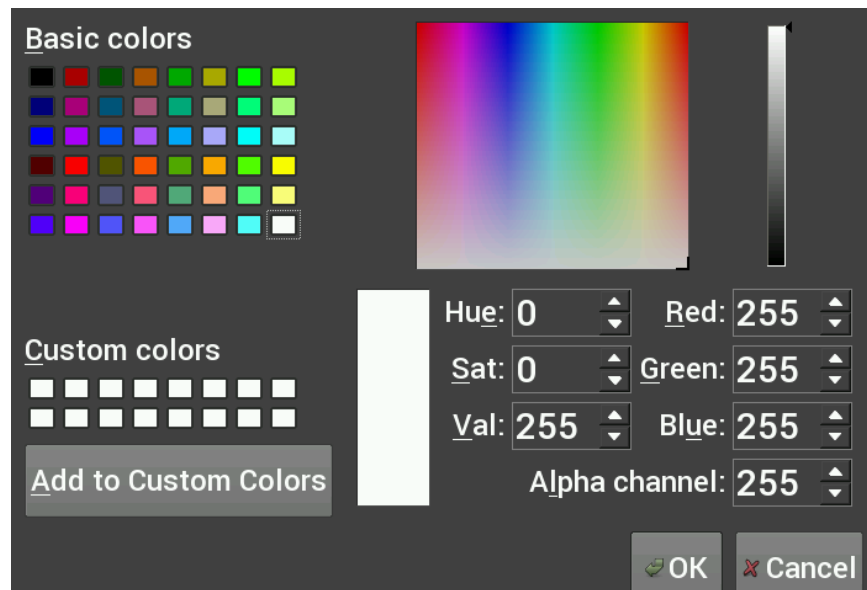

## Background Color

Changing the Background Color of a gauge is done following the same steps as the Foreground Color. The alpha channel controls the transparency of the background.

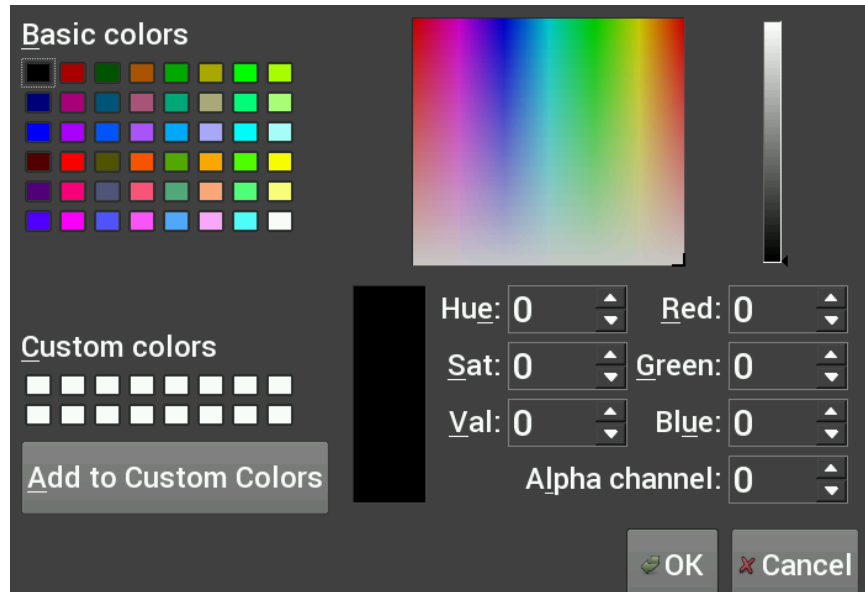

## Transparency

The transparency of a gauge background can be modified to achieve your desired style. A value of 255 makes the gauge completely opaque, and a value of 0 makes the gauge completely transparent. This is the same as setting the alpha channel in the color selection box for the gauge background. See the examples below.

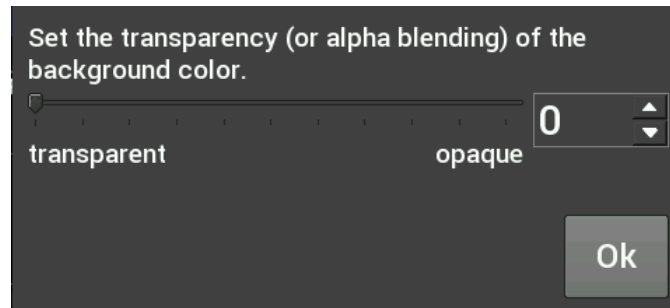

Transparency values are 255 / 125 / 0



Transparency values are 255 / 150 / 65 / 0

## Precision

Changing the precision of a gauge will show more or less decimal points after the whole number. Tachometers generally will not use any decimal places; however it may be beneficial to display fuel flow or AFR values with one or more decimal place.

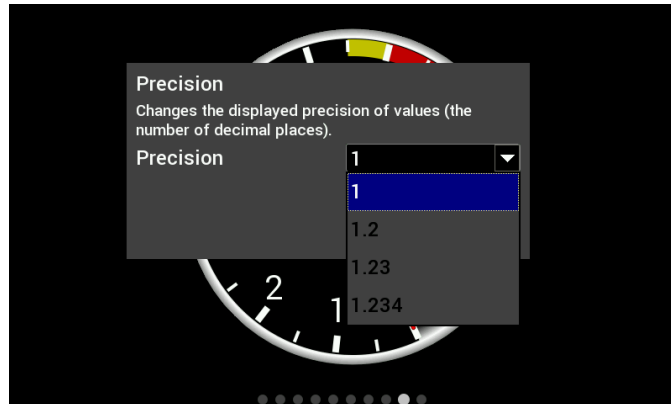

## Segments

Users can configure the number of segments on gauges. For example, a 0-8000 RPM tachometer with 8 segments would be divided into 1000 RPM increments. A 0-16,000 RPM tachometer would be divided into 2000 RPM increments.

Choose 0 segments to remove the scale completely.

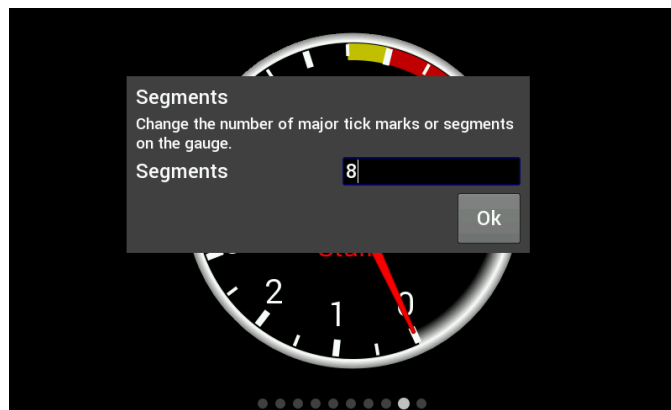

**NOTE:** Ensure the number of segments is matched up with the range you specify. E.g. If you choose 6 segments in a 0-8000 tachometer range, the scale markers will be at 0, 1333, 2667, 4000, 5333, 6667, and 8000. We would recommend using 4 or 8 segments instead.

## Scale Values Visible

This will toggle the Scale Values on or off.

## Scale Divisor

This value is the total range of a gauge divided by the number of segments. In this example, if you wanted the Scale Values of the tachometer to display 10, 20, 30... instead of 1, 2, 3... the scale divisor would be set to 100 instead of 1000.



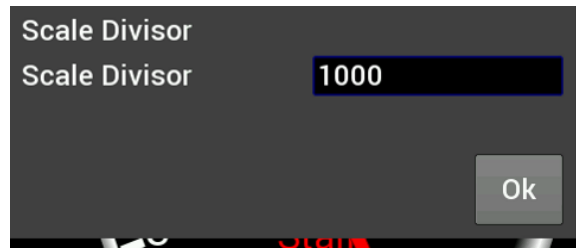

### **Size**

Overall Gauge sizes can be adjusted by increasing or decreasing their pixel size. The minimum and maximum values are displayed near the top of the number keypad. In this case, the min is 20 and the max is 780.

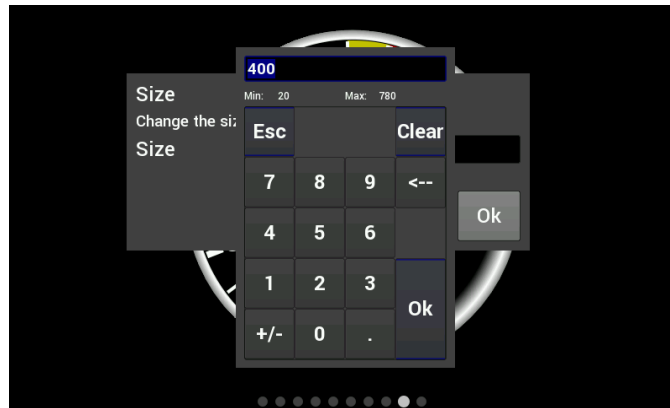

### **Value Display**

When Value Display is enabled, a digital meter will appear inside an analog gauge showing real time values in addition to the needle indicator.

### **Updates per Second**

This changes the speed at which values are refreshed on the dash and can be changed from 1/sec to 10/sec or full rate. These should be adjusted upon user preference.

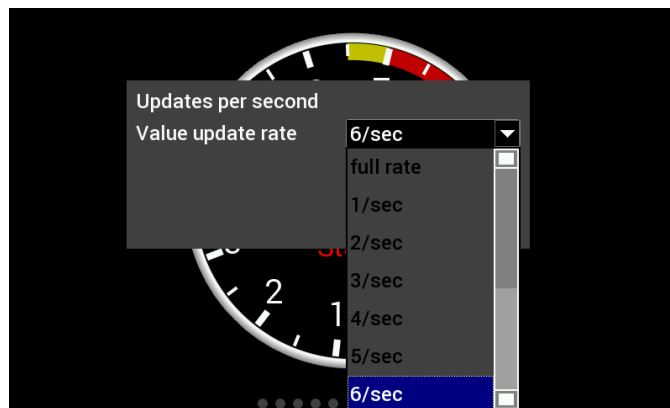

### **Border**

Borders around certain gauge types can be enabled or disabled by toggling this selection.

## Channel Math

Channel Math can be used to perform unit conversion on any gauge. The default value is '1' and this should be used if no conversion is desired. Any unused value may remain zero.

For simple multipliers use the 'Multiplier (b)' box. (Example, enter '1.60934' to convert MPH to KM/H).

<b>Conversion</b>	<b>a</b>	<b>b</b>	<b>c</b>
PSI to kPa	0	6.895	0
kPa to PSI	0	0.145	0
MPH to km/h	0	1.60934	0

Temperature gauges can from °F to °C by using the 'F to C' radio button. Selecting this option will automatically update the unit's label of the gauge and disable the user-defined multiplier.

If any gauges appear to read incorrectly, be sure to verify that this multiplier value has not been inadvertently changed.

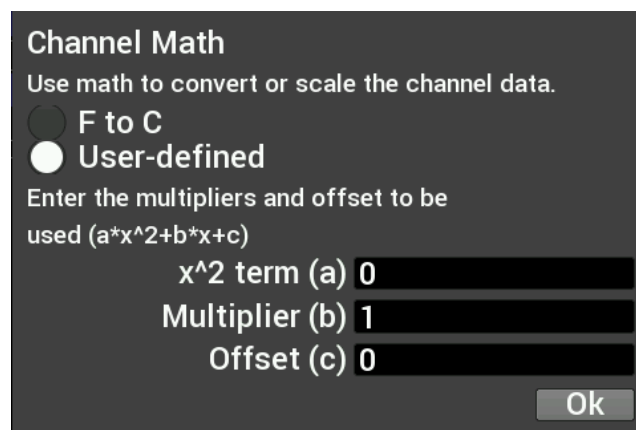

## Moving a Gauge

You can move a gauge anywhere on the screen. Press once on the gauge to bring up the menu and choose Move. Then press and hold on the gauge and drag it to where you want it to be.

## Adding Labels

Labels can be added anywhere on the gauge screen. The customization options for Labels include Font Size, Foreground & Background colors, and Transparency. See below for an example of the variety of sizes, colors and symbols that can be used.

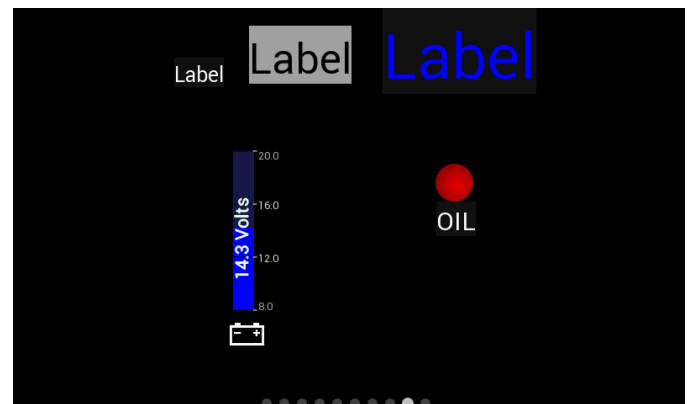
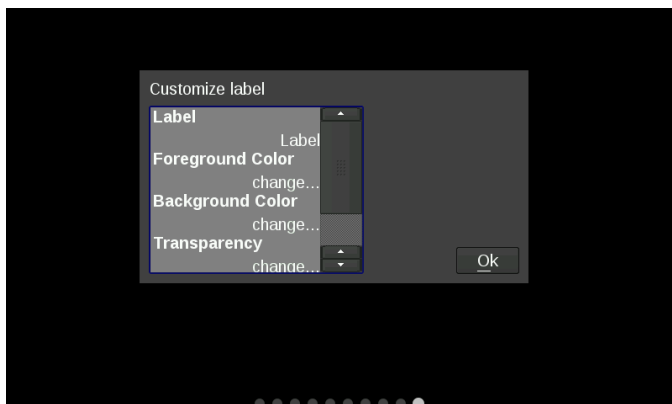

## Adding Switches

Switches can be placed anywhere on the gauge screen, they can be used to turn devices on or off, as a nitrous enable, etc. These functions are mapped through the Holley EFI software. Follow these steps for proper configuration:

1. Create an input in the I/O screen and give it a name – for this example we have named it “SWITCH 1”



2. Create an output in the I/O screen and give it a name – in this example we have named them “Cooling Fan”, “Elec Water Pump”, and “NOS Bottle Htr”. Once named, choose ‘Configure’ at the right of the screen.



3. Set the Switched Input Trigger to activate when ‘SWITCH 1’ is enabled

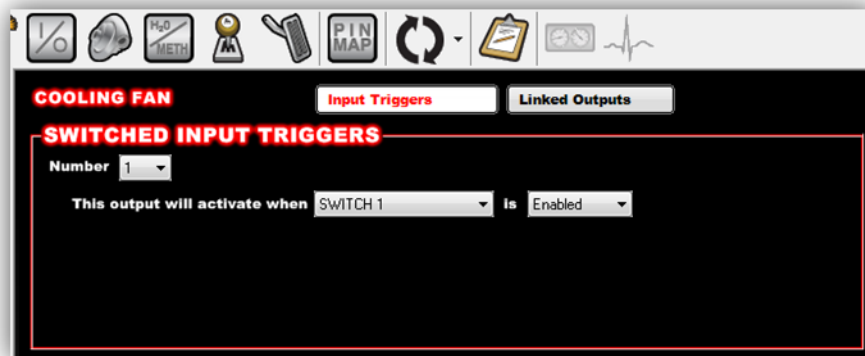

4. Go to the ‘PIN Map’ Icon, select ‘View LCD’ and drag the switch inputs to the appropriate pin number.



5. Select 'View Outputs' from the 'Pin Map' and drag the outputs to the whatever pin location the device was wired to.

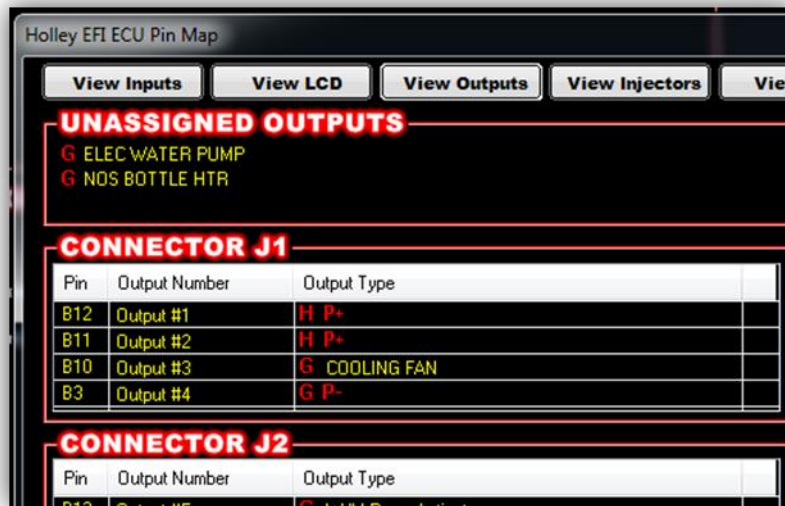

6. You will have to send the new configuration to the EFI and toggle the ignition for approximately 5 seconds for the changes to be saved. Turn on the ignition to continue.
7. Place a switch on the Holley EFI Pro Dash gauge screen by choosing 'Add' then 'Switch'. An option box in the upper right hand corner of the switch customize menu will allow mapping of the switch to the proper LCD Pin Map number that was configured in the Holley EFI software.
8. Customize the switch Label and other properties on the Dash and choose 'Ok'.

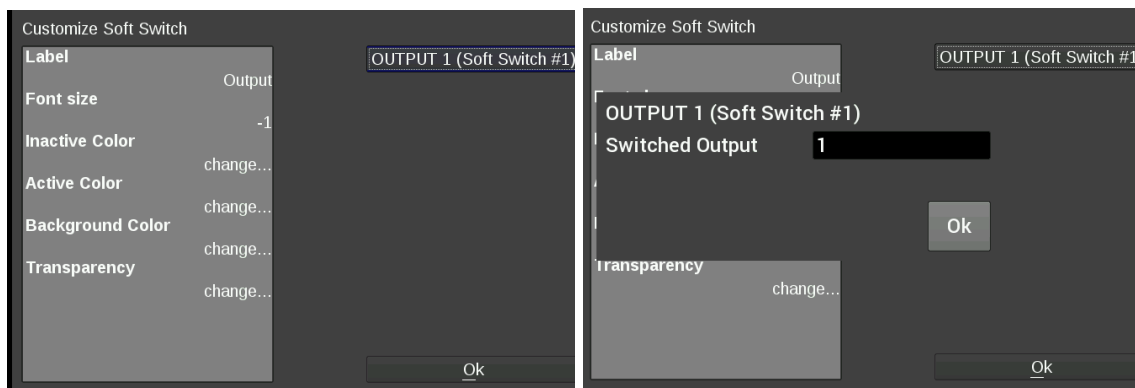

## Saving Your Layout

Once a layout has been created it must be saved. Touch any blank portion of the gauge screen and select Save.

## Exporting / Importing Layouts

You can save a copy of your layout in Customize mode by touching on any blank portion of the gauge screen and select Layout > Export. At this point, the layout can be given a name and saved internally to the Dash or to an external USB drive (if present). Click on the filename field to bring up a keyboard to personalize the filename. Once you have successfully saved the layout, touch any blank portion of the gauge screen and choose 'Save' or you may choose 'Save' from the top right hand corner of the gauge screen to return to the dashboard screen.

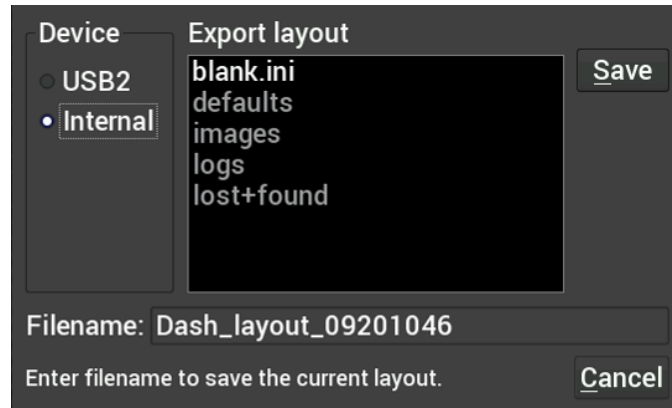

## Importing Layouts

You may import a layout from the defaults directory or USB drive by selecting Layout->Import. Navigate to the screen you want to import and select Import. Touch any blank portion of the gauge screen and choose 'Save' to return to the dashboard screen.

## Start-up Gauge Layout

The Dash will use the last saved layout as the start-up layout. To configure the screen that will be shown upon start-up of the Dash, follow these steps:

1. Toggle to the screen you would like displayed each time the unit is powered on.
2. Enter 'Customize' from the Main Menu.
3. Choose 'Save' in the top right corner of the gauge screen.

## Data Log Record and Playback

### Local Data Record

The Holley EFI Pro Dash has a record button that will record data logs directly to a USB flash drive or internal storage. The record button can be shown by pressing anywhere on the dashboard display.

Pressing this button will record accelerometer data, local dash inputs, ECU broadcast data and the data from the optional GPS directly to a USB flash drive or internal storage.

The data is recorded in the standard Holley Log File format and can be examined using PC software.

## Data Log Playback

The Holley EFI Pro Dash will play back logs that have been locally recorded using the 'Record' button or retrieved from a Holley EFI ECU. Pressing on the 'Playback' button in the upper left corner of the dashboard screen allows you to play back these logs from the Dash's internal storage or a USB drive.

The data log playback will animate the gauges with data that has been previously recorded. To return to the live data display, a 'Stop' button can be used from on the on-screen menu to stop the playback at any time.

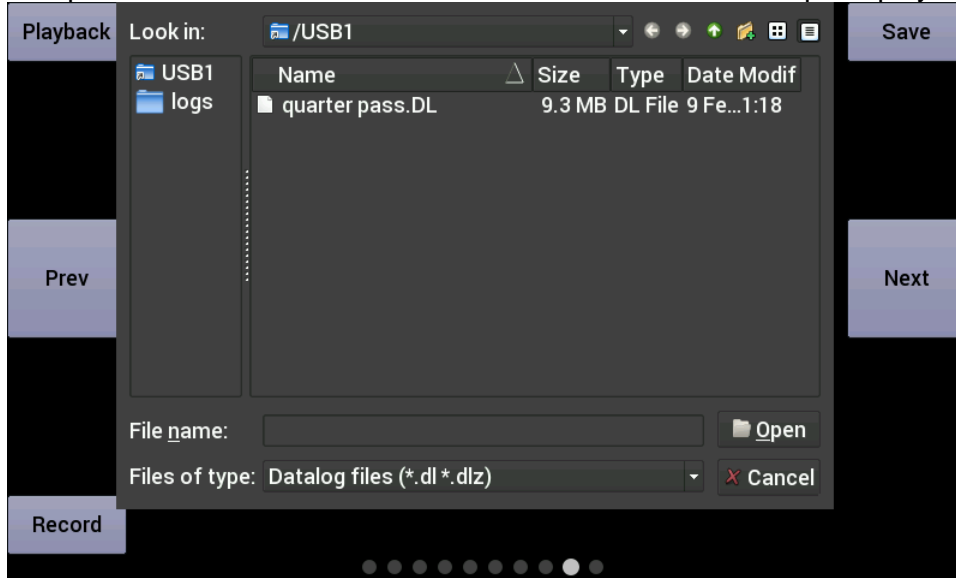

## USB Flash Drive Removal

If a USB Flash drive is plugged into one of the USB ports on the Pro Dash, an eject button will appear in the lower right corner of the dashboard on-screen menu. This ensures that all files are closed on the USB drive allowing a safe removal.

## Utilities Menu

From the utilities menu, you can upload/download global EFI configurations, access file utilities, backup/restore the dash configuration, and adjust security settings. Press on the 'X' at the top left corner to return to the main menu.

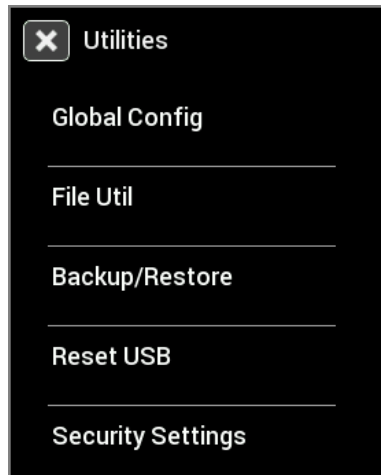

## Global Config

A global configuration contains the complete configuration of a Holley EFI in a single .hefi file. The Dash can upload and download global configs to the connect EFI.

### Downloading the Current EFI Configuration

Connect a USB flash drive to one of the USB cables attached to the Dash. Navigate to the desired device and folder where you want to store the current EFI configuration, and press Download to start the transfer.

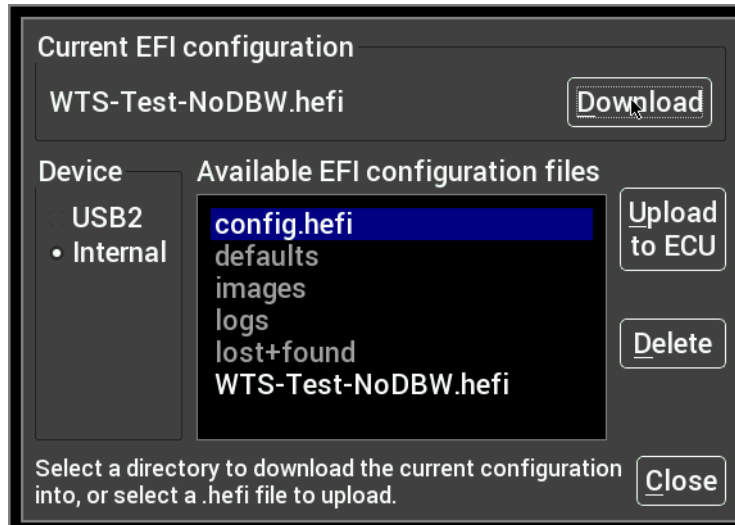

### Uploading a New EFI Configuration

To upload a new configuration to your Holley EFI, first ensure that the engine is not running. Navigate and select the desired .hefi configuration file and press Upload to ECU to start the transfer.

### Deleting EFI configuration files

If you no longer want to have a copy of the .hefi file you may remove it. Navigate to the desired file and press Delete.

## File Utilities

The utilities screen allows users to perform file functions such as deleting files and copying files to USB memory sticks.

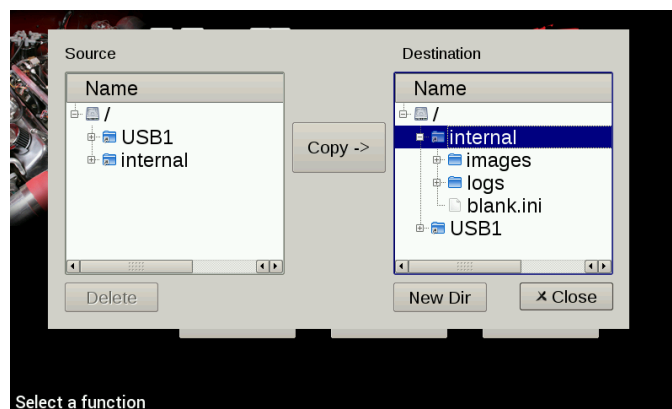

## Backup/Restore

Backup/Restore can be used to duplicate a dash configuration on a new dash. The backup includes all local dash configuration settings and screen layouts.

### Backup

To create a backup copy of the complete Dash configuration, choose Backup Configuration.

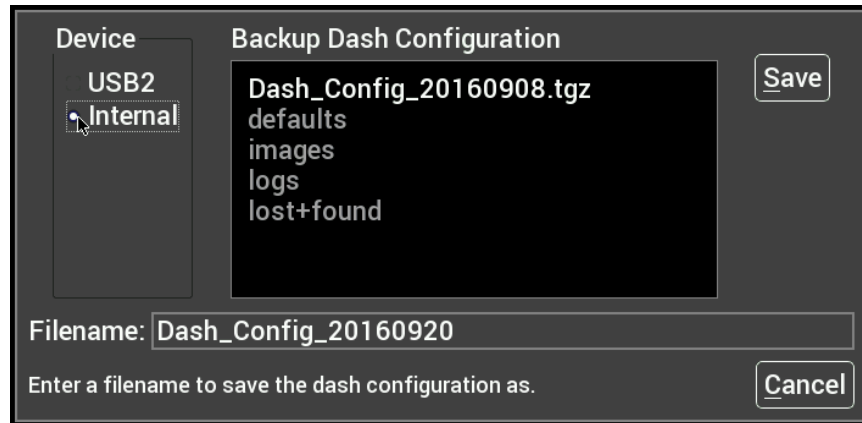

Navigate to where you want the backup file stored, adjust the filename if necessary and press Save.

### Restore

To restore a previously saved configuration, select the Restore Configuration from the menu, locate the desired Dash\_Config\_\*.tgz file and press Restore.

Factory default configurations can be restored from /internal/defaults/Dash\_Config\_V4.tgz for EFI connected units, or /internal/defaults/Dash\_Config\_SA.tgz for standalone operation.

## Security Settings

The Dash has the ability to lock out certain functionality. To disable a particular feature, place a checkmark beside the feature you wish to lock out.

### Default Password

Before you can change any settings, you will need to enter the default password of "holley" (without quotes.)



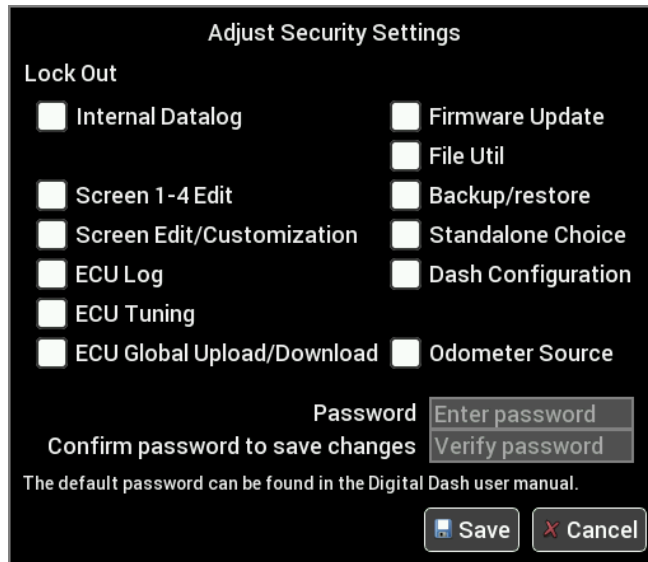

Item	Effect when checked (locked out)
Internal Datalog	Does not allow the user to record or play back a locally recorded logfile.
Screen 1-4 Edit	Does not allow the user to change the first four layout screen on the dashboard. Screens 5-10 are still editable.
Screen Edit/Customization	No screens can be edited or customized.
ECU Log	The user cannot download log files from the ECU.
ECU Tuning	The ECU Tuning menu is disabled
ECU Global Upload/Download	Global .hefi files cannot be uploaded or download to/from the ECU.
Firmware Update	The firmware cannot be updated on the unit.
File Util	File utilities menu is disabled
Backup/Restore	Dash backup and restore functionality is disabled
Standalone Choice	The user cannot switch between standalone and EFI-connected mode.
Dash Configuration	The user cannot change the local dash channel configuration, can device configuration, vehicle settings, or touchscreen calibration.
Odometer Source	The odometer source cannot be changed.

Once you have changed the options, click on the password box and enter a password to protect the option selections. The password is not echoed on the screen. You must confirm the password before you are allowed to save the selections.

If the options are greyed out, you will need to enter the password before you can change the options.

## EFI Tuning

The Pro Dash has been equipped to tune most of the EFI parameters. It is expected that the user is familiar with the PC tuning software and general EFI tuning principles.

From the main menu, choose the Tuning menu to adjust most of the parameters in your Holley EFI.

## Menu Organization

The left side contains the list of menus and items that can be used to change parameters on the EFI.

Menu	Parameters
Basic	Basic tuning parameters including fuel, closed loop/learning speed, spark, transmission shifts.
Advanced Tuning	Detailed fueling, idle, spark and individual cylinder tuning.
Performance	Performance items such as Launch, Rev Limiters, Nitrous, Boost, Traction Control, Water/Methanol, and Advanced Tables.
System Setup	Initial EFI configuration and other system options including Fans, Fuel Pump, A/C Shutdown, Engine Setup, Diagnostics selection, Ignition, Transmission. TPS autoset and Static Timing are also available from the System Setup Menu.
User 1 – User 4	Four user-customizable menus

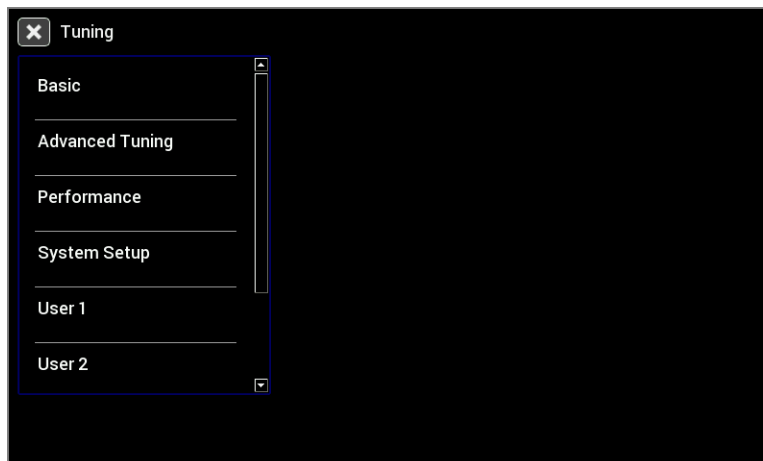

## Using the Tuning Menu

There are a number of different editors based on the value you choose to edit. The current value is displayed in light blue beneath the parameter label.

## Enable/Disable Toggle

Pressing on a toggle type menu item will toggle the state between disabled and enabled. Note that some additional parameters may appear in the menu list once enabled. For example, the Fan 1 on and off settings are not shown if Fan 1 is disabled.

## Numeric Editor

Selecting a parameter with a numeric value will bring up a numeric keypad and slider bar on the right half of the screen. You may use either the slider or keypad to change the value. The parameter limits are shown near the slider bar.

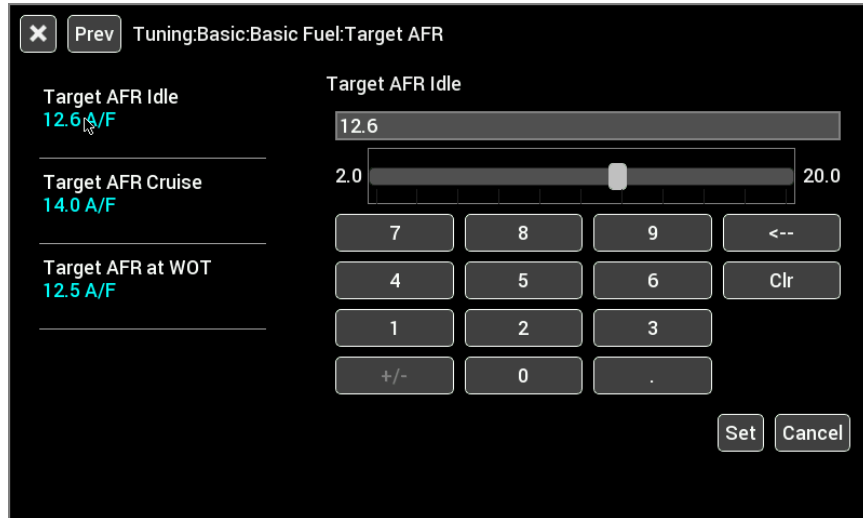

## Pull-Down/List

Parameters that have specific choices are displayed in a pull-down list. The current setting is displayed in blue, and pressing on the parameter brings up a pull-down list on the right side.

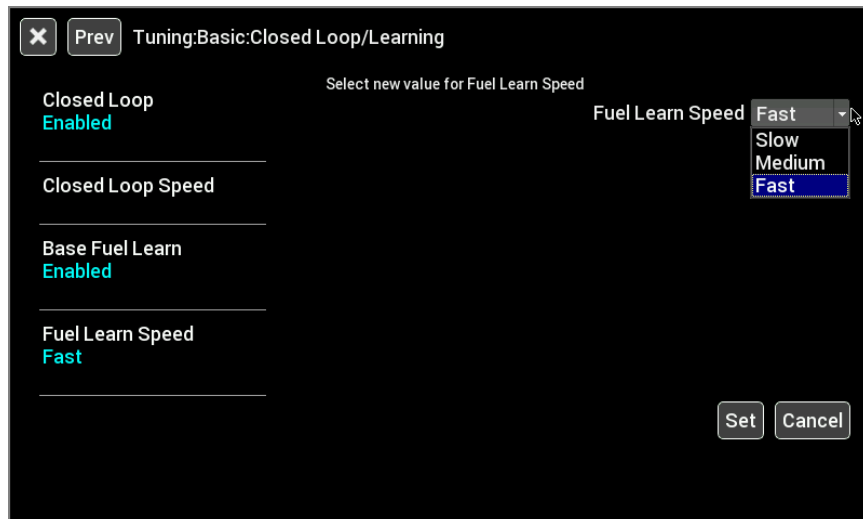

## Graph Editor

Parameters that are graphical will bring up the graph editor. Graphs can be edited by selecting a point and dragging it up and down, or by clicking on the yellow value box near the point you wish to edit.

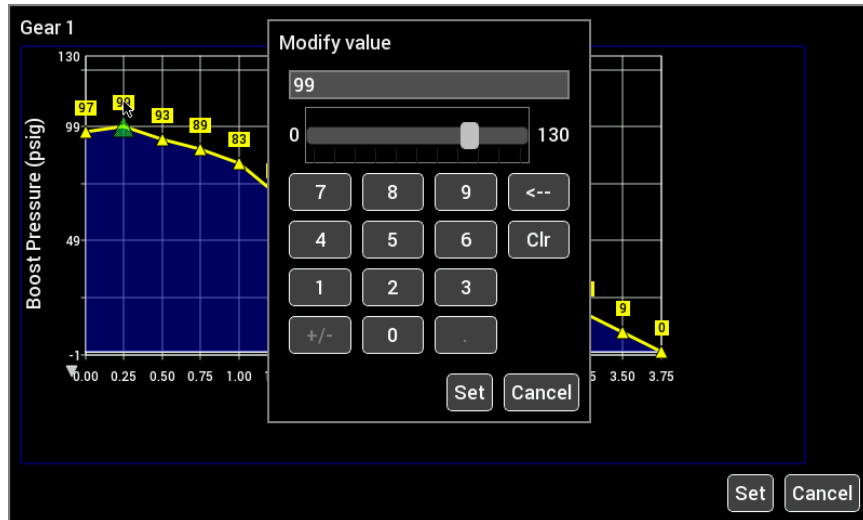

Multi-series graphs have a selection on the right hand side to select the series you are editing. The series that can be edited is shown in yellow. In the example below, 3-4 Upshift is selected.

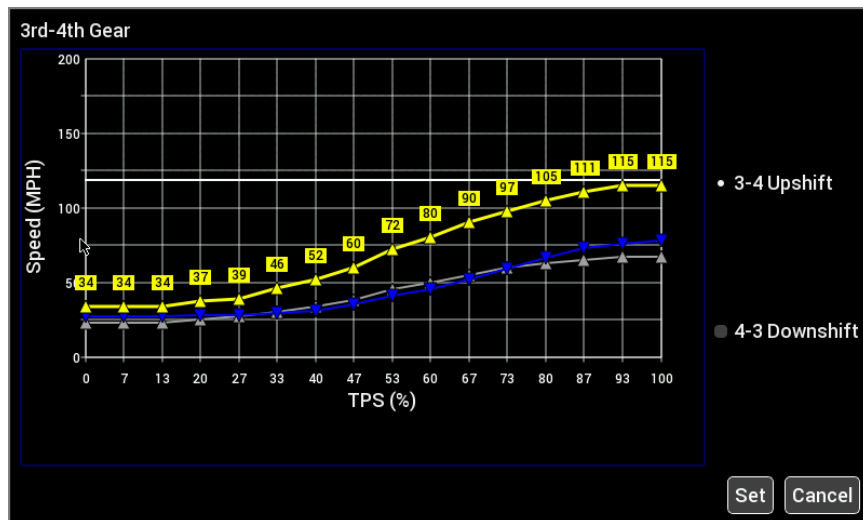

## Table Editor

In table editor you can select a single cell or multiple cells to edit. Press once on a single cell to select it, then press a second time to bring up the numeric table editor.

Multiple cells may be edited by first pressing and dragging to highlight the desired cell range in blue. Press on any blue selected cell to bring up the numeric table editor.

	500	600	700	800	900	1050	1200	1400	1600	1800	2000	2250	2500	2750
999	10.0	23.0	36.0	49.0	62.0	75.0	88.0	101.0	114.0	127.0	140.0	153.0	166.0	179.0
966	10.0	22.6	35.3	48.0	60.6	73.3	86.0	98.6	111.3	124.0	136.6	149.3	162.0	174.6
932	9.9	22.3	34.6	46.9	59.3	71.6	83.9	96.3	108.6	120.9	133.3	145.6	157.9	170.3
899	9.9	21.9	33.9	45.9	57.9	69.9	81.9	93.9	105.9	117.9	129.9	141.9	153.9	165.9
866	9.9	21.5	33.2	44.9	56.5	68.2	79.9	91.5	103.2	114.9	126.5	138.2	149.9	161.5
832	9.8	21.2	32.5	43.8	55.2	66.5	77.8	89.2	100.5	111.8	123.2	134.5	145.8	157.2
799	9.8	20.8	31.8	42.8	53.8	64.8	75.8	86.8	97.8	108.8	119.8	130.8	141.8	152.8
766	9.8	20.4	31.1	41.8	52.4	63.1	73.8	84.4	95.1	105.8	116.4	127.1	137.8	148.4
733	9.7	20.1	30.4	40.7	51.1	61.4	71.7	82.1	92.4	102.7	113.1	123.4	133.7	144.1
699	9.7	19.7	29.7	39.7	49.7	59.7	69.7	79.7	89.7	99.7	109.7	119.7	129.7	139.7
666	9.7	19.3	29.0	38.7	48.3	58.0	67.7	77.3	87.0	96.7	106.3	116.0	125.7	135.3
632	9.6	19.0	28.2	37.6	47.0	56.5	65.9	75.0	84.3	93.6	103.0	112.2	121.6	131.0

To perform smooth and interpolate operations, first select a range of cells then press on any selected cell to bring up the editor. Select Smooth or Interpolate then press Ok.

	-40	-20	0	20	40	60	80	100	120	140	160	180	200	220	240	260
999	-0.5	-0.4	-0.3	-0.3	-0.2	-0.2	-0.2	0.0	0.0	0.0	0.0	0.0	0.0	0.0	0.0	0.0
856	-1.3	-1.0	-0.9	-0.7	-0.6	-0.5	-0.4	-0.3	-0.2	0.0	0.0	0.0	0.0	0.0	0.0	0.0
714	-1.5	-1.2	-1.1	-0.8	-0.6	-0.4	-0.3	-0.2	0.0	0.0	0.0	0.0	0.0	0.0	0.0	0.0
571	-2.0	-1.3	-1.2	-1.0	-0.8	-0.6	-0.4	-0.3	-0.2	0.0	0.0	0.0	0.0	0.0	0.0	0.0
428	-2.0	-1.5	-1.3	-1.1	-1.0	-0.6	-0.4	-0.3	-0.2	0.0	0.0	0.0	0.0	0.0	0.0	0.0
285	-2.0	-1.5	-1.3	-1.1	-1.0	-0.8	-0.4	-0.3	-0.2	0.0	0.0	0.0	0.0	0.0	0.0	0.0
143	-2.0	-1.5	-1.3	-1.1	-1.0	-0.8	-0.5	-0.4	-0.2	0.0	0.0	0.0	0.0	0.0	0.0	0.0
0	-2.0	-1.5	-1.3	-1.1	-1.0	-0.5	-0.3	-0.2	0.0	0.0	0.0	0.0	0.0	0.0	0.0	0.0

**Function** -0.4

• **Set Value** -5.0      5.0

● **Add/Subtract** 7   8   9   <--

● **Offset by %** 4   5   6   Clr

● **Multiply** 1   2   3   Apply

● **Divide** +/-   0   .   Cancel

● **Smooth Selection**

● **Interpolate Selection**

A positive value makes the target A/F value leaner, a negative value makes it richer. A value of 0.0 performs no change.

To perform an action, select the desired function, type in a value and press Apply. Changes are not sent to the EFI until the 'Save' button is pressed.

Function	Description
Set Value	Sets all selected cells to the same value
Add/Subtract	Adds an offset to the selected cells.
Offset by %	Offsets each selected cell by a percentage. 100% doubles the value.
Multiply	Multiplies each selected cell by a value
Divide	Divides each selected cell by a value
Smooth Selection	Smooths the selection using neighboring cell values
Interpolate Selection	Perform a linear interpolation of values using the four corner cells in the selection

## User Customizable Menus

You can change the title of the user customizable menu by pressing on the menu label for more than 2 seconds. A keyboard will appear allowing you to change the name of the menu.

To add items to a user menu, you must first navigate to the desired item. Press on the desired menu item label for more than 2 seconds and a dialog box will appear allowing you to select which menu to add or remove this item to.

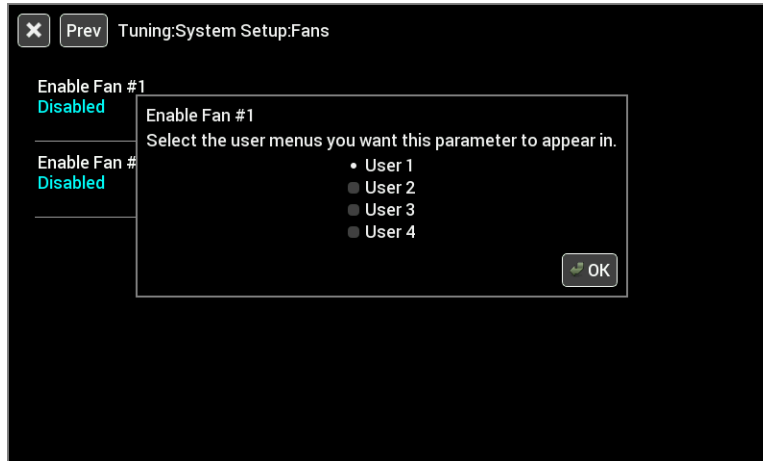

## Cleaning

If screen needs cleaning, use the supplied microfiber cleaning cloth. Do not use harsh chemical cleaners on the touch screen display.

Do not subject the display to a high pressure water stream from a pressure washer.

## Appendix A

### List of EFI Monitored Values

Below is a list of 283 values that can be monitored. Any user programmed I/O values will appear in the list in addition to these once the Dash has been connected to a Holley ECU. Note that this list is dependent on the ECU software version.

RTC	INJ PW1	N2O STAGE 6	DIAG #10
RPM	INJ PW2	N2O STAGE 7	DIAG #11
INJ PW	INJ PW3	N2O STAGE 8	DIAG #12
DUTY CYCLE	INJ PW4	GPO 1	DIAG #13
CL COMP	INJ PW5	GPO 2	DIAG #14
TARGET AFR	INJ PW6	GPO 3	DIAG #15
AFR LEFT	INJ PW7	GPO 4	DIAG #16
AFR RIGHT	INJ PW8	GPO 5	DIAG #17
AFR AVERAGE	INJ PW9	GPO 6	DIAG #18
AIR TEMP ENR	INJ PW10	GPO 7	DIAG #19
COOLANT ENR	INJ PW11	GPO 8	DIAG #20
COOLANT AFR OFFSET	INJ PW12	N2O ENABLED	ADV LAUNCH INPUT
AFTERSTART ENR	CYL FUEL CORR1	N2O INPUT #1	ADV SHIFT INPUT
CURRENT LEARN	CYL FUEL CORR2	N2O INPUT #2	ADV GEAR
CL STATUS	CYL FUEL CORR3	N2O INPUT #3	ADV AT 1D1
LEARN STATUS	CYL FUEL CORR4	N2O INPUT #4	ADV AT 1D2
FUEL ECONOMY	CYL FUEL CORR5	N2O INPUT #5	ADV AT 1D3
FUEL FLOW	CYL FUEL CORR6	N2O INPUT #6	ADV AT 1D4
MAP RoC	CYL FUEL CORR7	N2O INPUT #7	ADV AT 1D5
TPS RoC	CYL FUEL CORR8	N2O INPUT #8	ADV AT 1D6
TUNING CHANGE	CYL FUEL CORR9	N2O PURGE	ADV AT 1D7
ESTIMATED VE	CYL FUEL CORR10	N2O LEAN CUTOFF	ADV AT 1D8
IGNITION TIMING	CYL FUEL CORR11	N2O RICH CUTOFF	ADV AT 2D1
KNOCK RETARD	CYL FUEL CORR12	N2O RPM CUTOFF	ADV AT 2D2
KNOCK LEVEL	CYL FUEL CORR13	N2O MAP CUTOFF	ADV AT 2D3
IAC POSITION	CYL FUEL CORR14	N2O PURGE OUTPUT	ADV AT 2D4
MAP	CYL FUEL CORR15	N2O DRY FUEL 1	ADV AT 2D5
TPS	CYL FUEL CORR16	N2O DRY FUEL 2	ADV AT 2D6
MAT	CYL TIMING CORR1	N2O DRY FUEL 3	ADV AT 2D7
CTS	CYL TIMING CORR2	N2O DRY FUEL 4	ADV AT 2D8
BARO	CYL TIMING CORR3	N2O DRY FUEL 5	ADV AT 1D/GEAR 1
BATTERY	CYL TIMING CORR4	N2O DRY FUEL 6	ADV AT 1D/GEAR 2
OIL PRESSURE	CYL TIMING CORR5	N2O DRY FUEL 7	ADV AT 1D/GEAR 3
FUEL PRESSURE	CYL TIMING CORR6	N2O DRY FUEL 8	ADV AT 1D/GEAR 4
PEDAL POSITION	CYL TIMING CORR7	N2O TIMING MOD1	ADV AT 1D/GEAR 5
MAIN REV LIMIT	CYL TIMING CORR8	N2O TIMING MOD2	ADV AT 1D/GEAR 6
REV LIMIT #1	CYL TIMING CORR9	N2O TIMING MOD3	ADV AT 1D/GEAR 7
REV LIMIT #2	CYL TIMING CORR10	N2O TIMING MOD4	ADV AT 1D/GEAR 8
AC KICK	CYL TIMING CORR11	N2O TIMING MOD5	ADV AT 2D/GEAR 1

TIMING RETARD #1	CYL TIMING CORR12	N2O TIMING MOD6	ADV AT 2D/GEAR 2
TIMING RETARD #2	CYL TIMING CORR13	N2O TIMING MOD7	ADV AT 2D/GEAR 3
TIMING RETARD #3	CYL TIMING CORR14	N2O MTIMING MOD8	ADV AT 2D/GEAR 4
FAN #1	CYL TIMING CORR15	N2O TIMER1	ADV AT 2D/GEAR 5
FAN #2	CYL TIMING CORR16	N2O TIMER2	ADV AT 2D/GEAR 6
#2 FUEL PUMP	TGT FUEL PRESSURE	N2O TIMER3	ADV AT 2D/GEAR 7
AC SHUTDOWN	BOOST PSIG	N2O TIMER4	ADV AT 2D/GEAR 8
TCC LOCKUP	BOOST GEAR	N2O TIMER5	ACC X
SENSOR WARNING	BOOST STAGE	N2O TIMER6	ACC Y
SENSOR CAUTION	BOOST	N2O TIMER7	ACC Z
BASE FUEL LB	BOOST SPEED	N2O TIMER8	GPS QUAL
BASE FUEL VE	BOOST TIME	TRANS GEAR	GPS SPEED
BASE TIMING	TARGET BOOST	TRANS SPEED	GPS LAT
BASE TAFR	TRANS BRAKE	LINE PRESSURE	GPS LONG
BASE IGN DWELL	BOOST SCRAMBLE +	INPUT SHAFT SPEED	GPS ELV
VOL COMP IGN DWELL	BOOST SCRAMBLE -	ACCUM PRESSURE	GPS DIR
INJ END ANGLE	MANUAL BOOST BUILD	TCC DUTY CYCLE	DASH IO1
ECU LOG TRIGGER	MANUAL BOOST RESET	LINE TEMP	DASH IO2
TIMING AIR TEMP	BOOST BUILD	TORQUE TIME	DASH IO3
TIMING COOLANT TEMP	BOOST SOLENOID DUTY	TRANS MAN UPSHIFT	DASH IO4
STATUS1	BOOST SAFETY	TRANS MAN DNSHIFT	DASH IO5
STATUS2	BOOST MASTER ENABLE	TRANS AUTO/MAN	DASH IO6
STATUS3	BOOST MANUAL SHIFT IN	TB TPS #1	DASH IO7
STATUS4	BOOST MANUAL STAGE IN	TB TPS #2	DASH IO8
STATUS5	BOOST FILL SOL DC	PEDAL TPS #1	DASH IO9
STATUS6	BOOST VENT SOL DC	PEDAL TPS #2	DASH IO10
STATUS7	W/M INJECTION	TB2 TPS #1	DASH CAN1
STATUS8	W/M MANUAL ENABLE	TB2 TPS #2	DASH CAN2
INJ PPH1	W/M LOW FLUID	TB POSITION	DASH CAN3
INJ PPH2	W/M PUMP STATUS	TB2 POSITION	DASH CAN4
INJ PPH3	W/M SOL FLOW1	BRAKE PEDAL	DASH CAN5
INJ PPH4	W/M SOL FLOW2	DIAG #1	DASH CAN6
INJ PPH5	W/M TOTAL FLOW	DIAG #2	DASH CAN7
INJ PPH6	W/M SOL DC1	DIAG #3	DASH CAN8
INJ PPH7	W/M SOL DC2	DIAG #4	DASH CAN9
INJ PPH8	N2O STAGE 1	DIAG #5	DASH CAN10
INJ PPH9	N2O STAGE 2	DIAG #6	DASH ODOMETER
INJ PPH10	N2O STAGE 3	DIAG #7	
INJ PPH11	N2O STAGE 4	DIAG #8	
INJ PPH12	N2O STAGE 5	DIAG #9	



## Appendix B

The following are additional complete layouts that can be found in /internal/defaults.



nismo blue



blue 1

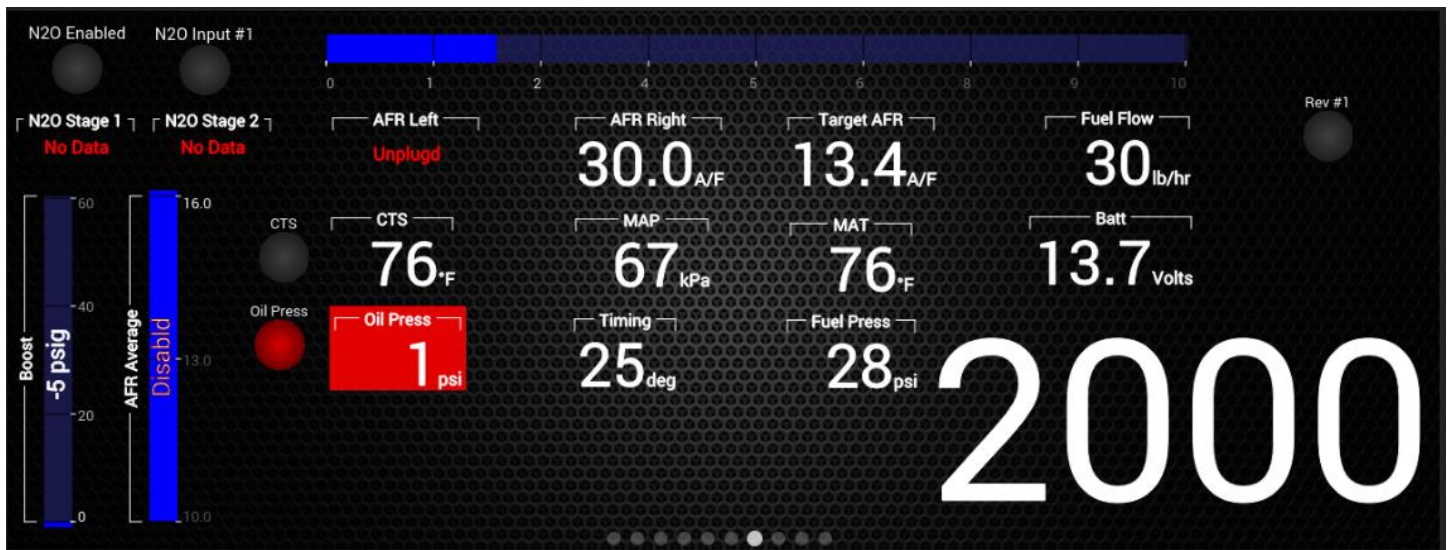

DP race 1



GF race 1

## Appendix C

The following preloaded background images can be found in /internal/images.

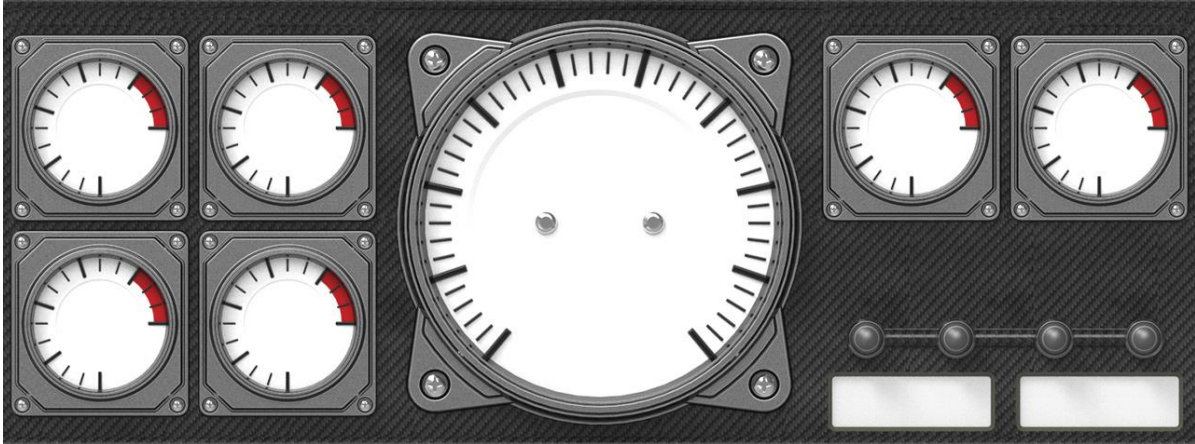

**Cockpit – 5 Color Versions Available**

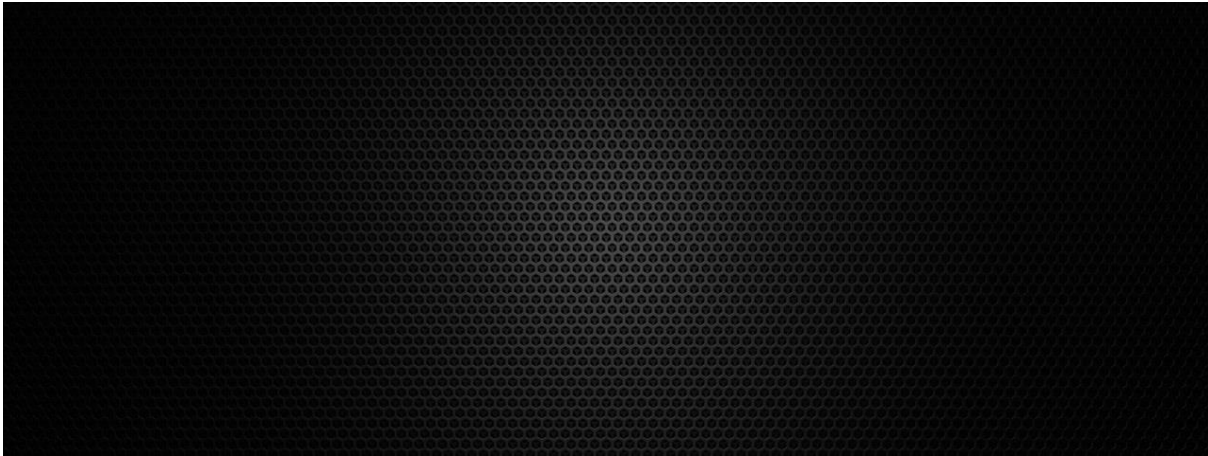

**DarkPerforated**

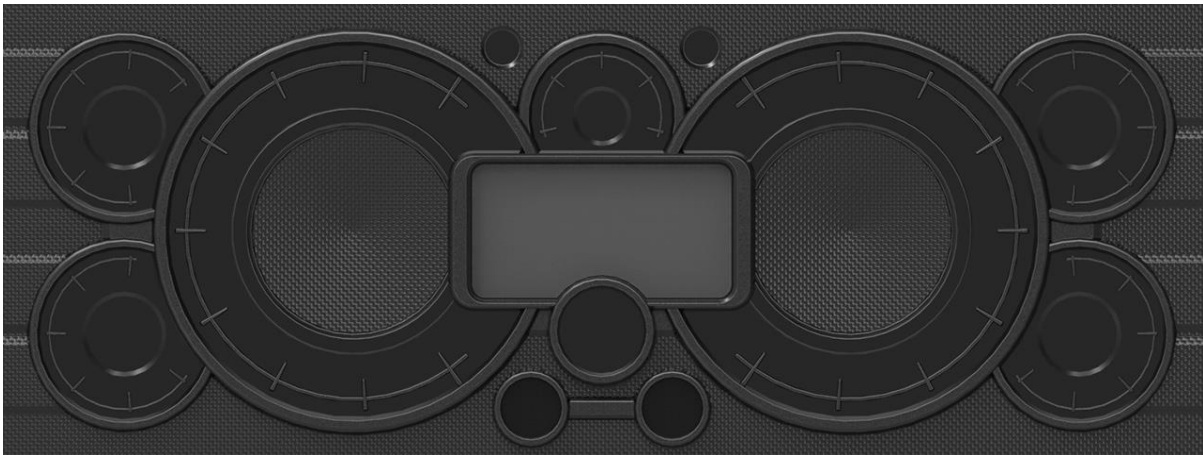

**Ducati – 6 Color Versions Available**



**GalaxyFire**

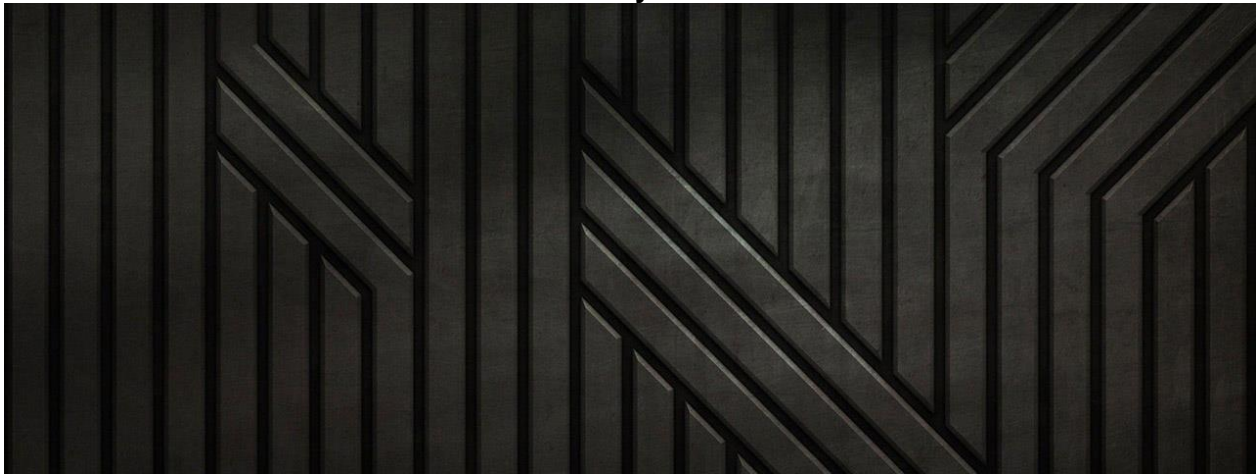

**GeoTexture**



**GrungeMetal – 6 Versions**



**HolleyLS – 3 Versions**



**LaFerrari-Digital – 4 Versions**

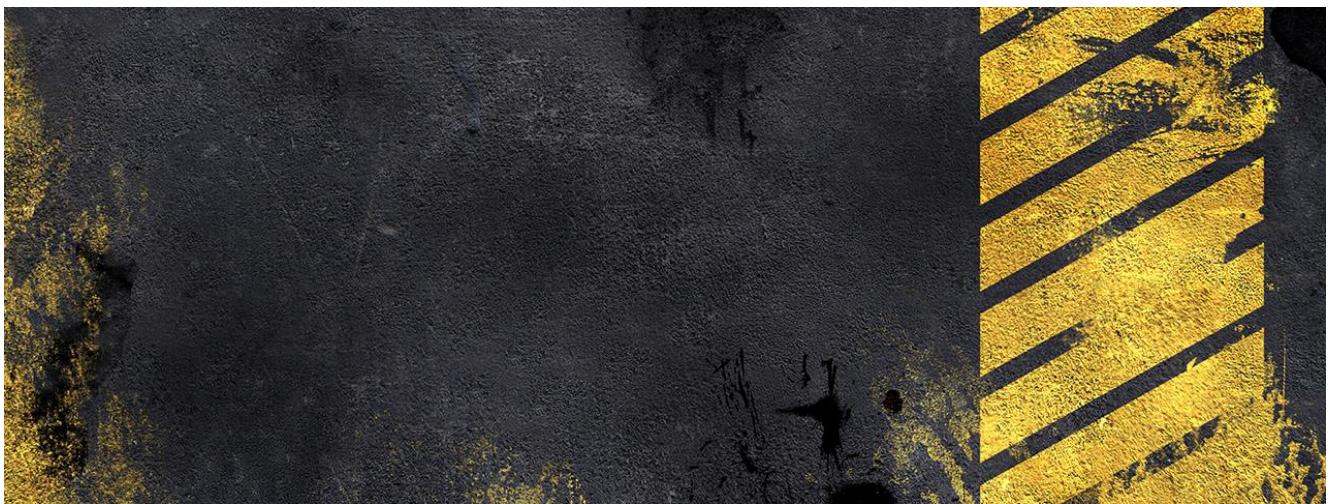

**Meltdown**



**Modern-Base – 4 Colors**

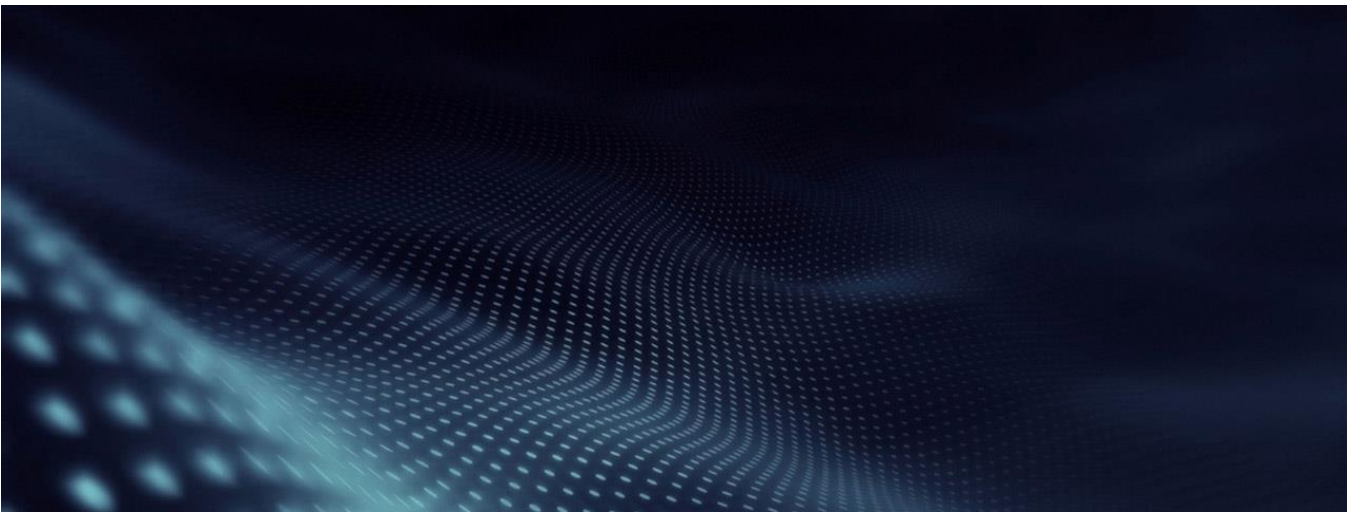

**Modern-FieldofDots**



**Nismo-Blue**

**1999R11581**  
**Date: 9-6-18**